

IMPORTANT SAFETY INSTRUCTIONS

When using an electrical appliance, basic safety precautions should always be followed, including the following.

Read all instructions before using this sewing machine.

When the machine is not in use, it should be disconnected from the electricity supply by removing the plug from the power outlet.

DANGER

To reduce the risk of electric shock:

1. An appliance should never be left unattended when plugged in.
2. Always unplug this appliance from the electric outlet immediately after using and before cleaning.

WARNING

To reduce the risk of burns, fire, electric shock or injury to persons:

1. Do not allow to be used as a toy. Close attention is necessary when this appliance is used by or near children.
2. Use appliance only for its intended use as described in this manual. Use only attachments recommended by the manufacturer as contained in this manual.
3. Never operate this appliance if:
 - it has a damaged cord or plug,
 - it is not working properly,
 - it has been dropped or damaged
 - it has fallen into water
 Return the appliance to the nearest authorized dealer or service center for examination, repair, electrical or mechanical adjustment.
4. Never operate the appliance with any air openings blocked. Keep ventilation openings of the sewing machine and foot controller free from accumulation of lint, dust and loose cloth.
5. Keep fingers away from all moving parts. Special care is required around the sewing needle.
6. Always use an original or recommended BERNINA stitch plate. The wrong plate can cause the needle to break.
7. Do not use bent needles.
8. Do not pull or push fabric while stitching. It may deflect the needle causing it to break.
9. Turn power switch to "0" when making any adjustments in the needle area, such as threading or changing the needle, threading the bobbin or changing the presser foot.

10. Always unplug the sewing machine from the electrical outlet when removing covers, lubricating or when making any other user servicing adjustments mentioned in this instruction manual.
11. Never drop or insert any object into any opening.
12. Do not use outdoors.
13. Do not operate where aerosol (spray) products are being used or where oxygen is being administered.
14. To disconnect, turn all controls to the off ("0") position then remove the plug from the outlet.
15. Do not unplug by pulling on the cord but grasp the plug before pulling.
16. No responsibility will be taken for any possible damage as the result of misuse of the machine.
17. This machine is provided with double insulation. Use only identical replacement parts. See instructions for Servicing of Double-Insulated machines.

SERVICING DOUBLE-INSULATED PRODUCTS

In a double-insulated product, two systems of insulation are provided instead of grounding. No means of grounding is provided on a double-insulated product nor should a means for grounding be added to the product. Servicing a double-insulated product requires extreme care and knowledge of the system and should only be done by qualified service personnel. Replacement parts for a double-insulated product must be identical to those parts in the product. A double insulated product is marked with the words "DOUBLE INSULATION" or "DOUBLE INSULATED".

The symbol  may also be marked on the product.

SAVE THESE INSTRUCTIONS!

This sewing machine is intended for household use only.

BERNINA®



“Welcome
to the
BERNINA
family!”

H.P. Ueltschi

H.P. Ueltschi
BERNINA Sewing
Machine Company

Choosing a **BERNINA Sewing & Embroidery System** is a decision which will have a positive impact on your sewing for years to come.

Customer satisfaction has been the driving force of our family company for over 100 years and I intend to continue that tradition of delivering superb Swiss quality, future-orientated sewing technology and unrivaled customer service.

The **new BERNINA family of creative sewing machines** gives you the unique opportunity to select what you need to satisfy your sewing needs and requirements.

As the name suggests, the “artista” range of computer sewing is pure artistry.

These machines provide unlimited scope for total sewing pleasure. They inspire creativity and allow you to translate your ideas into practical sewing of the finest quality.

In addition, a wide range of sewing accessories, together with sewing publications full of practical and creative ideas, add to the **joy of sewing the BERNINA way.**

It gives me great pleasure to welcome you into the BERNINA family.

Fritz Gegauf Ltd. · BERNINA Sewing Machines · CH-8266 Steckborn/Switzerland

1	Safety Instructions
2	Foreword
4–5	Details of the machine
6–12	Setting up the machine
13–14	Stitch Summary
15	Presser feet
16–17	Practical stitches/buttonholes
18–21	General instructions
22–28	Functions
29	Messages
29–37	Buttonholes
37–38	Alphabets/numbers
38–43	Memory
44	Quilt stitches
45	Balance
46	Help
47–48	TC (Tutorial / Creative Consultant)
49	Smart function
50–61	Setup program
62	eco (ecology) function
62–65	Optional accessories
65–67	Needles, Thread, Fabric feed
68	Cleaning and maintenance
69	Troubleshooting
70	Glossary of terms
71–72	Index

Details of the machine

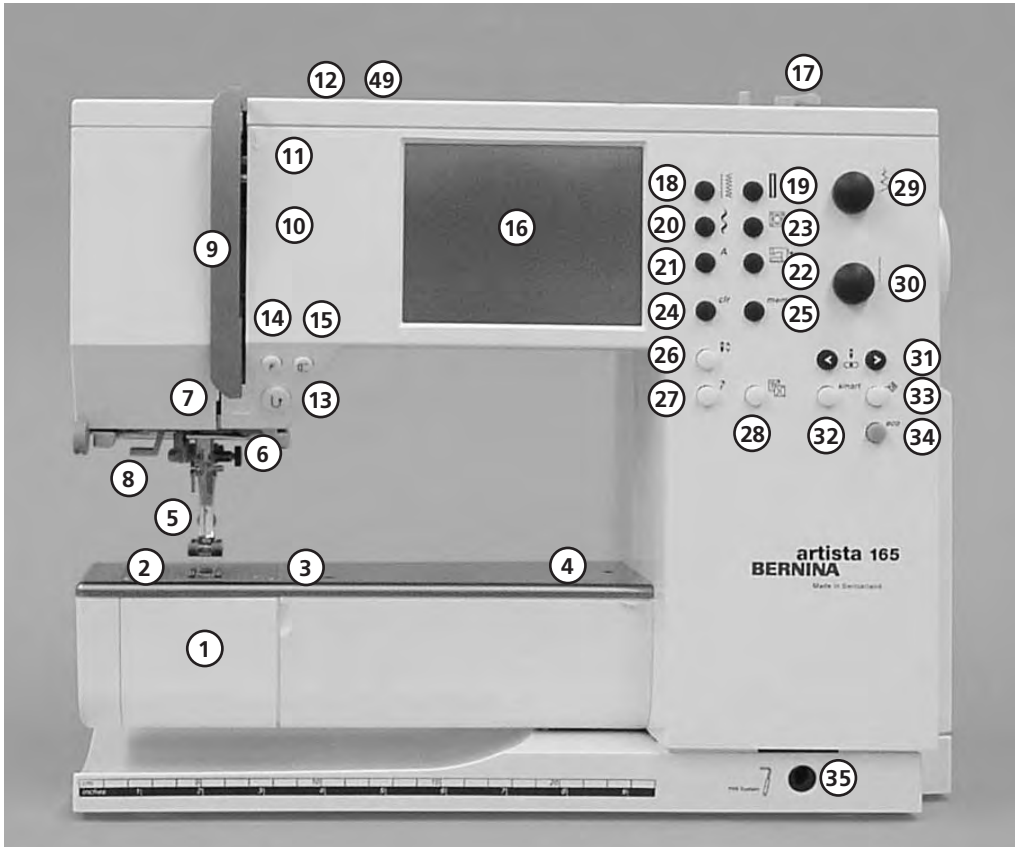

Front view

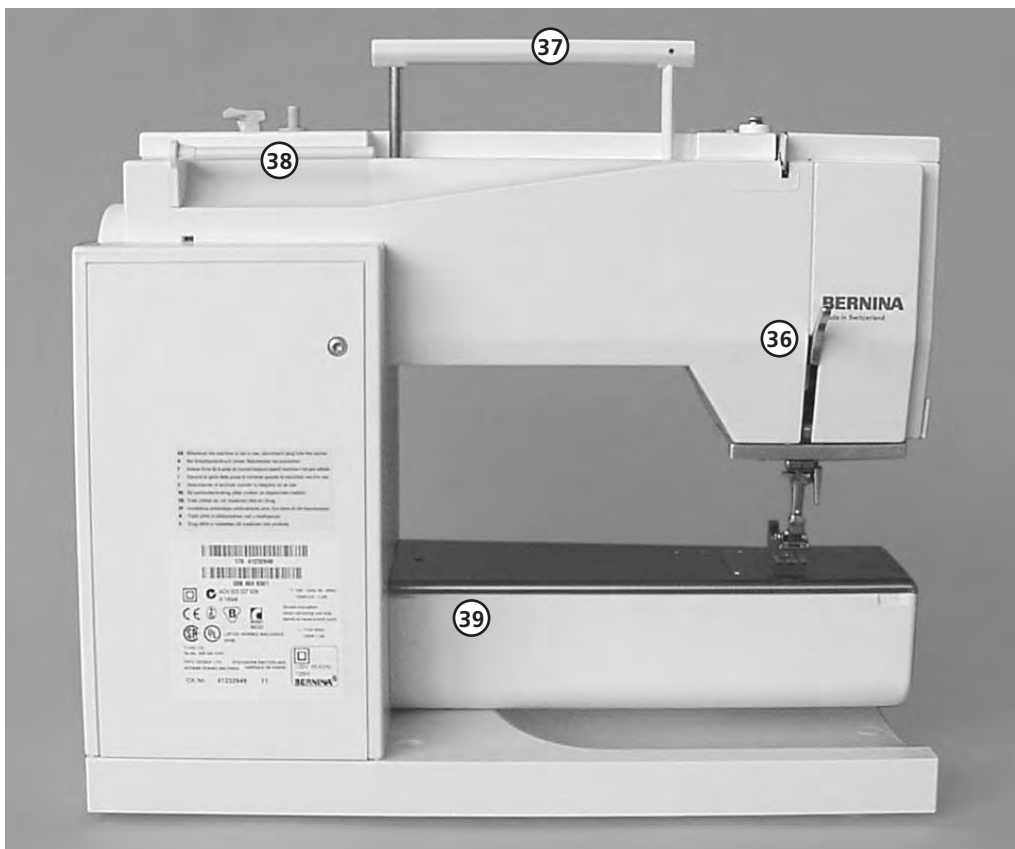

Back view

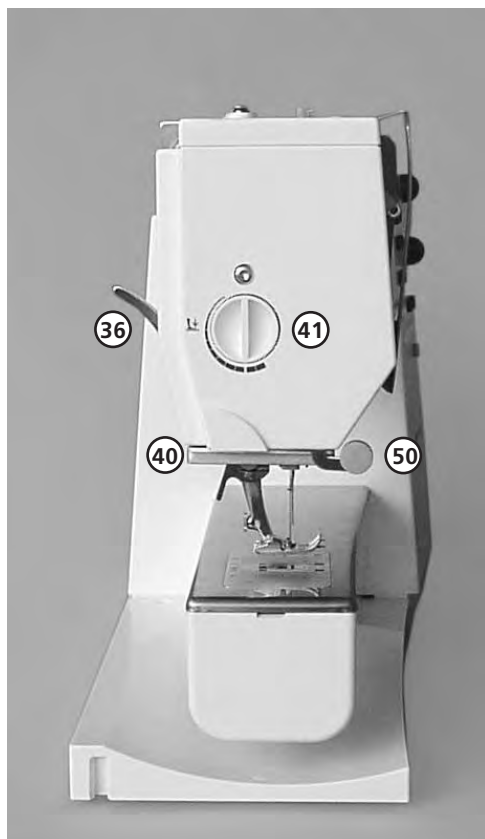

View from the left side



View from the right side

- 1 Bobbin cover
- 2 Stitch plate
- 3 Attachment base for optional accessories
- 4 Darning ring connection
- 5 Presser foot
- 6 Needle clamp
- 7 Thread guide
- 8 Needle threader
- 9 Thread take-up cover
- 10 Thread path
- 11 Thread take-up
- 12 Bobbin pre-tension
- 13 Quick reverse button
- 14 F (Favorite Function) button
- 15 Pattern end
- 16 Screen
- 17 Bobbin winder with on/off switch and thread cutter
- 18 Practical stitch button
- 19 Buttonhole button
- 20 Decorative stitch button
- 21 Alphabet button
- 22 External embroidery button
- 23 Quilt stitch button
- 24 clr (Clear) button
- 25 mem (Memory) button
- 26 Needle stop up/down
- 27 "?" (Help) button
- 28 TC (Tutorial/Creative Consultant) button
- 29 Stitch width knob
- 30 Stitch length knob
- 31 Needle position smart button
- 32 setup button
- 33 eco (Ecology) button
- 34 FHS connection (optional accessory)
- 35 FHS connection (optional accessory)
- 36 Presser foot lifter (manual)
- 37 Carrying handle
- 38 Spool pins
- 39 Sewing table socket
- 40 Thread cutter
- 41 Presser foot pressure dial
- 42 Handwheel
- 43 Power switch on/off
- 44 Power plug socket
- 45 Drop feed-dog
- 46 Foot control socket
- 47 Embroidery module connection (optional accessory)
- 48 PC serial port
- 49 Tension adjustment
- 50 Magnifying glass holder

Carrying case



Carrying case

- protects from dust and dirt
- compartment for accessories

Accessories

- foot control
- instruction manual
- power cable
- warranty card
- FHS presser foot lifter (Free Hand System)
- ruler for sewing table
- sewing table (attached)
- To remove the sewing table, lift slightly and remove.



To remove the case

- grasp both sides
- pull up vertically

Accessory box



Standard accessories *

- 4 bobbins
- selection of 130/705H needles
- seam ripper
- small screwdriver
- brush
- seam guide
- reverse pattern foot No.1
- overlock foot No.2
- buttonhole foot No.3
- automatic buttonhole foot No.3A
- zipper foot No.4
- blind stitch foot No.5
- embroidery foot No.6
- jeans foot No.8
- height compensating tool
- vertical spool holder pin
- three spool discs
- foam pad
- Compensation plate for sewing buttonholes

*can vary from country to country

Important:

(USA/Canada only!)

Use only foot controller type LV1
with sewing machine models 165.

Power cable

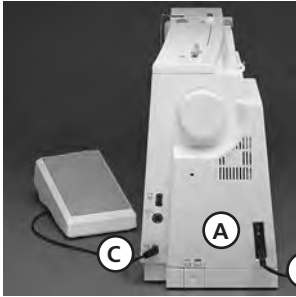

The power cable is stored in the case

- plug A into machine
- plug B into electrical outlet

Foot control cable

- plug C into machine

Important! (USA/Canada only)

This sewing machine has a polarized plug (one blade wider than the other). To reduce the risk of electric shock, this plug is intended to fit only one way into a polarized outlet. If the plug does not fit fully in the outlet, reverse the plug. If it still does not fit, contact a qualified electrician to install the proper outlet. Do not modify the plug in any way.

Foot control

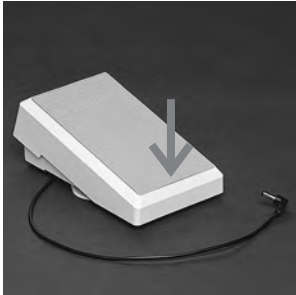

Sewing speed

- control the sewing speed by depressing the foot control with your toe
- raise or lower the needle by tapping on the foot control with your heel

Use only foot controller type LV1 for sewing machine model 165 (USA/Canada only)



Cable tidy

- wind the cable round the spool
- insert the plug into **A**

When sewing

- unwind the cable to the desired length and slip into **B** or **C**

Power switch



The power switch is on the handwheel side of the machine

- 1** the machine is switched on
- 0** the machine is switched off

The sewing light is switched on and off within the Setup program.

Refer to the safety instructions!

Sewing table



Larger sewing surface

- the sewing table increases the sewing surface
- free arm for larger tubular items such as pant legs and waistbands

To attach

- push over the free arm and press firmly so that it engages on the fixing lug (needle and presser foot fully raised)

To remove

- pull to the left
- remove

Seam guide

- insert into the groove (underside of table) from the right
- it can be freely adjusted over the whole width of the table

Scale

- number "0" corresponds to the centre needle position

FHS (Free Hand System) presser foot lifter



Raising and lowering the presser foot.

- the presser foot lifter raises and lowers the presser foot
- push to the right with your knee
- the presser foot is raised and the feed-dogs are lowered simultaneously
- the feed-dogs come up automatically as soon as the first stitch is sewn

Attaching the presser foot lifter

- the presser foot lifter is stored in the case.
- insert the presser foot lifter into the opening in the base plate
- you should be able to operate the lifter in your normal sitting position.

Note:

Your dealer can adjust the position if necessary.

Winding the bobbin

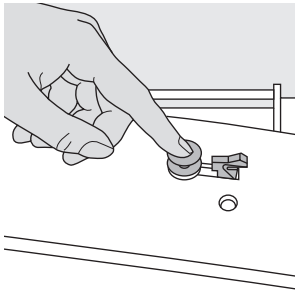

Winding the bobbin

- turn power switch on
- place empty bobbin on spindle

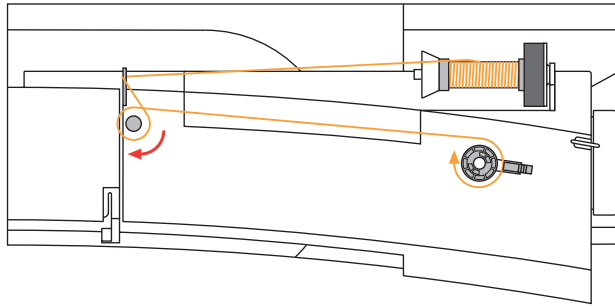

Threading the bobbin

- following the direction of the arrow take thread through the rear guide and round the pre-tension stud
- wrap the thread around the inner bobbin two or three times and cut off any excess thread on the thread cutter
- press the engaging lever against the bobbin
- press the foot control
- the motor stops automatically when the bobbin is full
- remove the bobbin

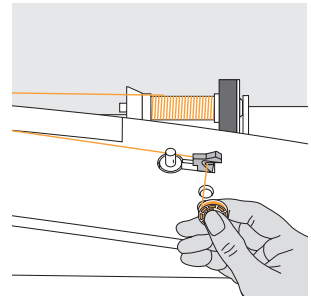

Thread cutter

- cut the thread on the thread cutter

Bobbin case

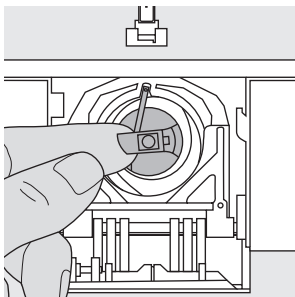

To remove

- raise the needle
- turn power switch to 0
- open the accessory box cover
- open the bobbin cover
- grasp the latch of the bobbin case
- remove case

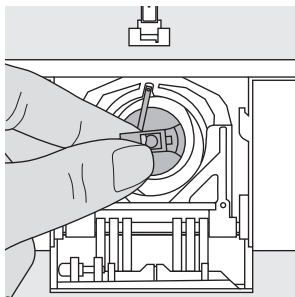

To insert

- hold the bobbin case latch
- the opening on the case should be at the top
- insert so that it engages
- close the bobbin cover
- close the accessory box cover

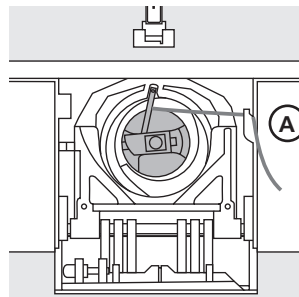

Bobbin thread cutter

- insert the bobbin case
- take thread over cutter **A**
- cut thread

Refer to the safety instructions!

Note:

For normal sewing, the bobbin thread does not have to be brought up as the loose end is just the right length to start sewing.

Inserting the bobbin

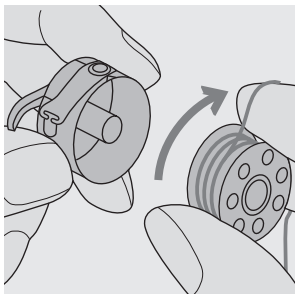

Insert the bobbin so that the thread runs clockwise.

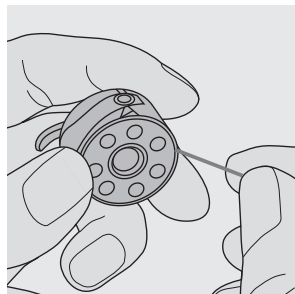

Pull the thread counter-clockwise into the slot.

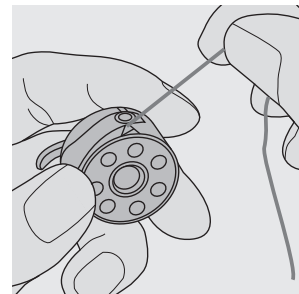

Pull the thread to the left under the spring until it lies in the T-shaped slit at the end of the spring.

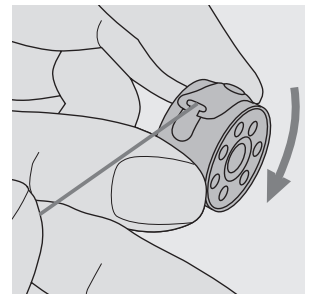

The bobbin must turn clockwise when the thread is pulled.

Changing the needle

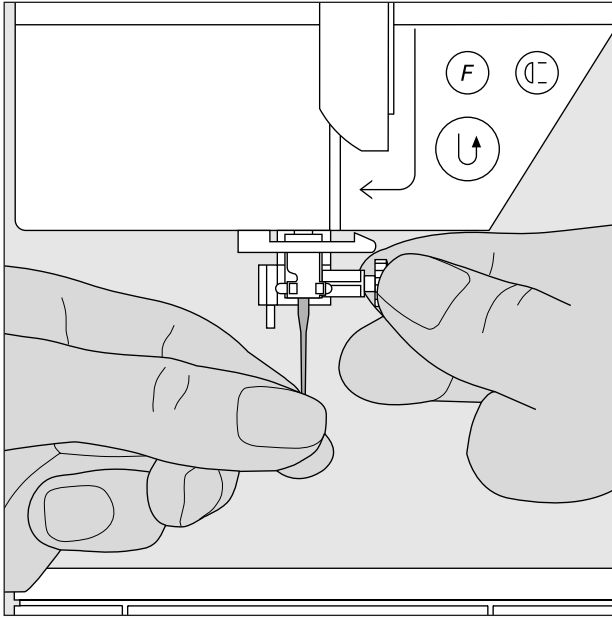

Removing the needle

- raise the needle
- turn power switch to 0
- lower the presser foot
- loosen the needle clamp with the torx screwdriver
- pull the needle down to remove

Inserting the needle

- flat side of needle to the back
- insert the needle as far as it will go
- tighten the needle clamp

Refer to the safety instructions!

Changing the presser foot

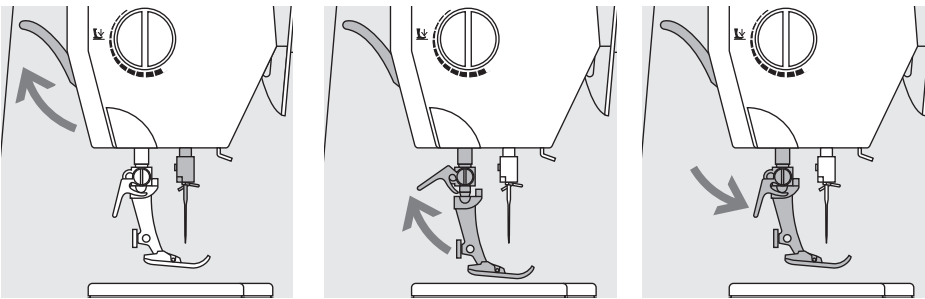

Changing the presser foot

- raise the needle and presser foot
- turn power switch to "0"

Raising the lever

- raise the clamping lever
- remove the presser foot

Attaching the presser foot

- guide the foot upwards over the cone
- press the clamping lever down

Refer to the safety instructions!

Supplementary spool pin (vertical)

Vertical spool pin

- the supplementary spool pin (vertical) is stored in the accessory box
- insert the pin from right to left in the opening
- to remove, pull to the right at the base of the spool pin
- essential sewing aid when using more than one thread, i.e. double needle, etc.
- threads wound onto spools in a stacked manner work best when feeding from a vertical spool pin
- using a vertical spool pin with metallic threads will help avoid fraying and splitting of the thread

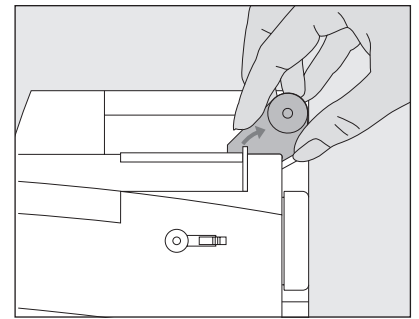
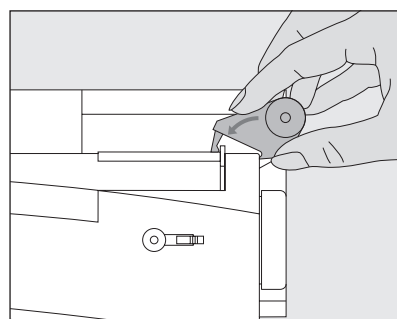

Threading the upper thread

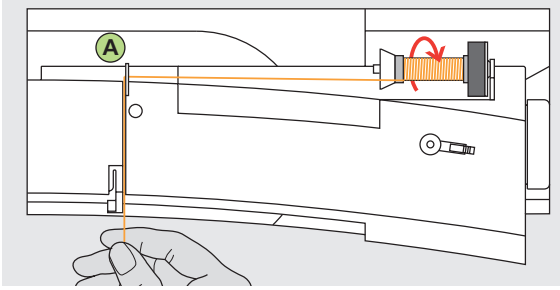

Attaching the thread spool

- raise the needle and presser foot
- turn the power switch to «0» (off)
- attach the foam pad
- place spool on pin (spool turns clockwise)
- attach the appropriate spool disc - diameter of spool disc is disc size. There must be no clearance between the disc and the spool
- take thread through rear guide **A**
- then into slit of upper thread tension

Down

- pull thread down to the right of the take-up cover to **B**

Up

- take thread up to the left of the cover to **C** in the direction of the arrow

Down

- take thread down and through guides **D** and **E**

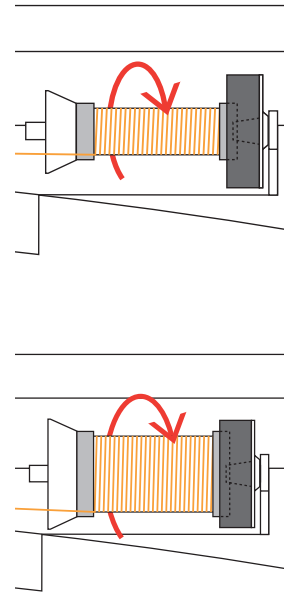
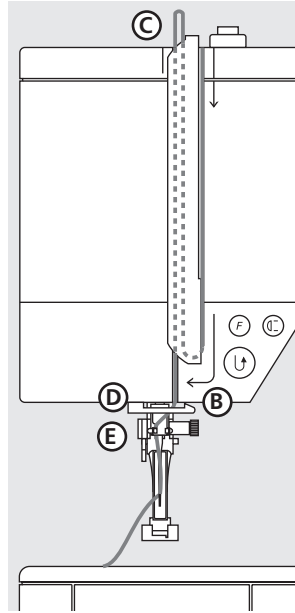

Refer to the safety instructions!

Needle threader

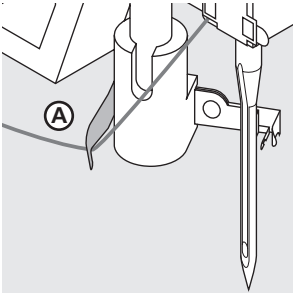

Thread in hook

- lower the presser foot
- lay the thread behind hook **A** and hold lightly

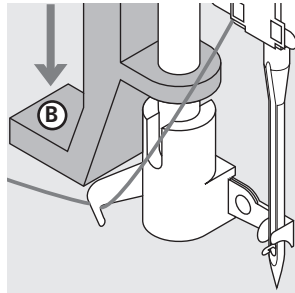

Lever down

- press lever **B** down

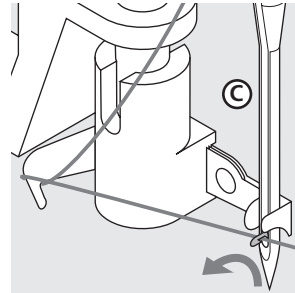

Thread in front of needle

- take the thread in front of the needle **C**
- pass the thread from the bottom to the top of the needle until it catches in the hook

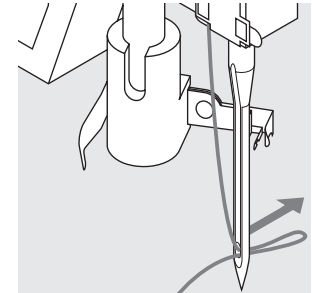

Let go of lever and thread

- let go of lever **B** and thread
- pull the thread loop through the needle eye

Bringing up the lower thread

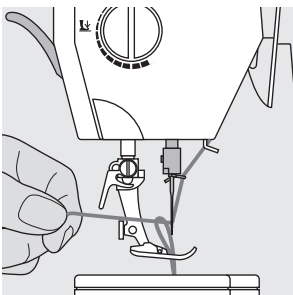

Bringing up the lower thread

- if bobbin thread is cut on the cutter (page 8), there is no need to bring it up
- hold the upper thread
- sew one stitch
- pull the upper thread to bring the lower thread up through the stitch plate hole
- take both threads through the slit on the presser foot to the back
- pull threads over the cutter

Note:

The bobbin thread must be brought up through the stitch plate for certain types of work. The length of thread is sufficient for most normal work if the lower thread cutter has been used.

Thread cutter

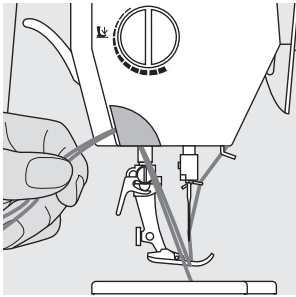

Thread cutter on head frame

- lower the presser foot and pull both threads from front to back over the cutter
- the threads release as soon as the first stitch is sewn

Stitch Plate

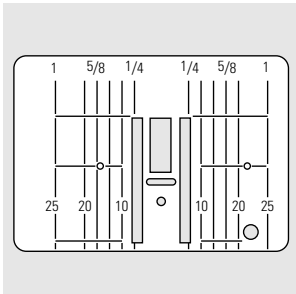

Stitch plate markings

- the stitch plate is marked with vertical lines in mm and inches
- mm measurements are at the front
- inch measurements are at the back
- the measurements correspond to the distance from the needle to the line
- needle insertion point is position 0 (center needle position)
- the mm/inch measurements are marked to the right and left
- the lines help to guide the fabric for perfectly spaced stitching
- the horizontal markings are helpful for sewing buttonholes, etc.

Feed-dog

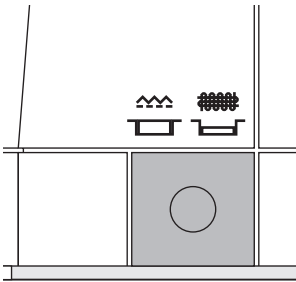

Button under the handwheel

- Button flush with base plate = sewing position
- for all machine-fed sewing



- Button depressed = feed-dog is lowered
- for free-hand sewing (darning, free-hand embroidery, free-hand quilting)
- for embroidery with the Embroidery Module



Presser foot pressure

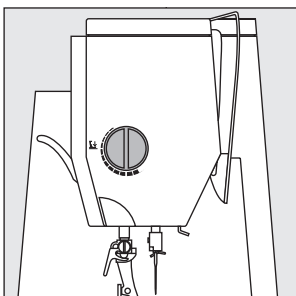

Dial on head frame

- the presser foot pressure dial is on the left of the head frame

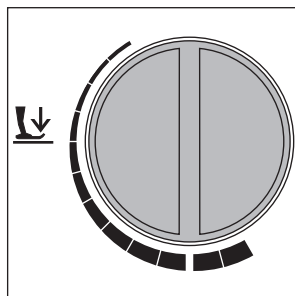

Standard pressure

- for all normal sewing

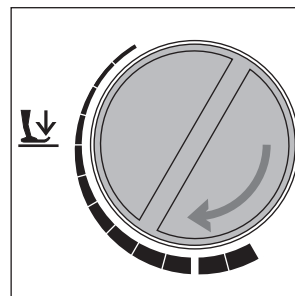

Reduced pressure

- for jerseys and loose knits, quilting
- prevents fabric stretching
- adjust pressure so that the fabric still feeds correctly

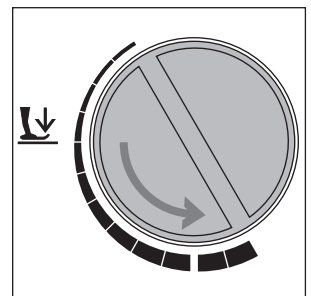

Increased pressure

- for sheer, slippery lightweight fabrics, quilting
- improves fabric feed and prevents puckering

Thread tension

The tension is factory set for best possible sewing results using a 100 weight, 3 ply polyester thread (100/3). Other types and weights can affect the stitch, causing a need for a tension adjustment to get the best results.

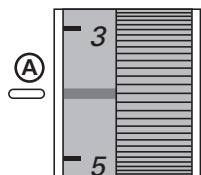

Basic setting

- the basic setting is indicated when the red line on the tension adjustment wheel is in line with the marking A
- the tension does not need adjusting for normal sewing work
- for special sewing, the tension can be adjusted to suit the fabric

To reduce the tension

- Adjust to between 3 and 1

To increase the tension

- Adjust to between 5 and 10

Different threads, including embroidery and decorative threads, may require tension adjustments. The tensions should be adjusted to suit the thread, fabric and stitch.

Example:

	Tension	Needle
Metallic thread	approximately 3	90
Monofilament	approximately 2–4	80

Practical stitches

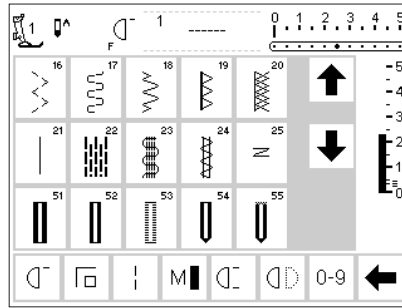
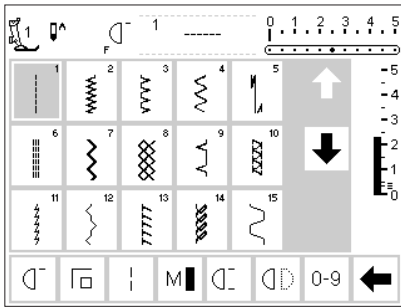

Buttonholes

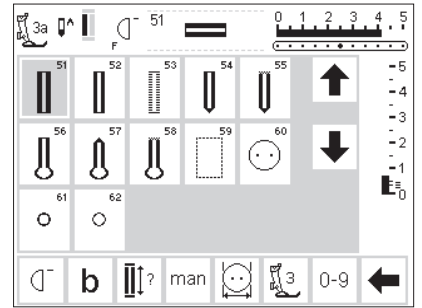

Decorative stitches

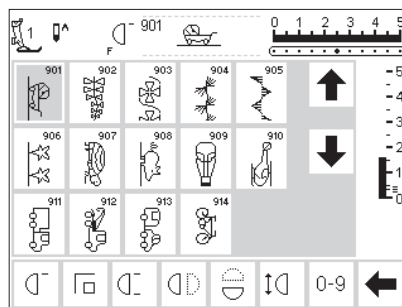
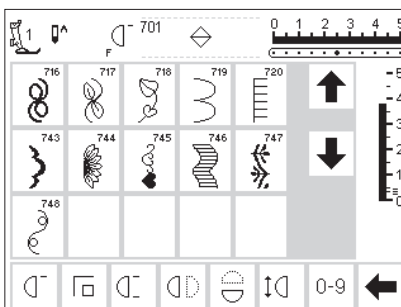
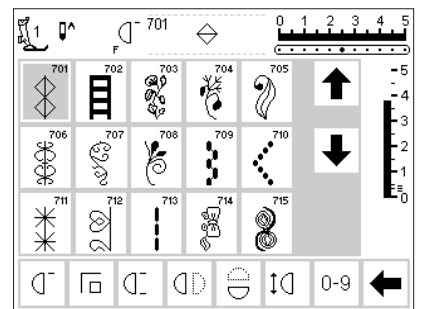
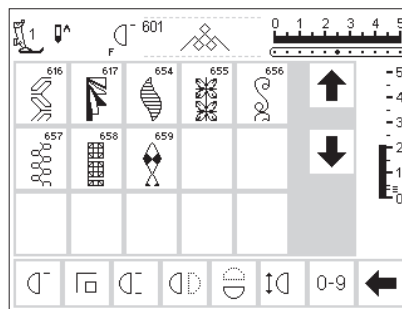
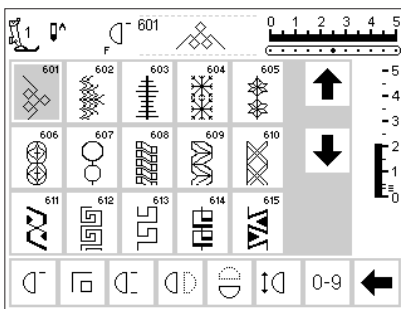
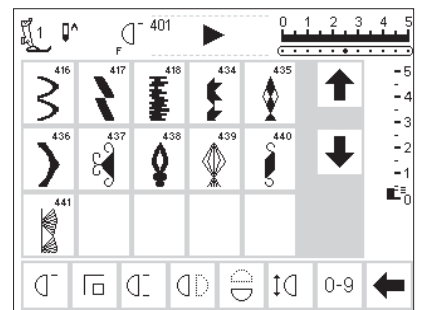
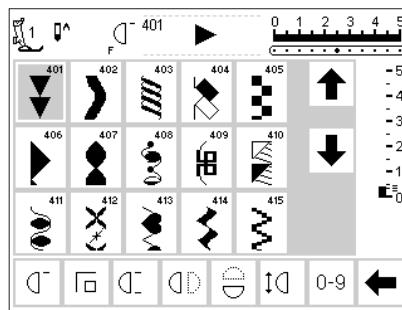
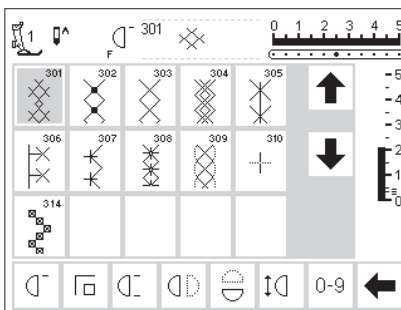
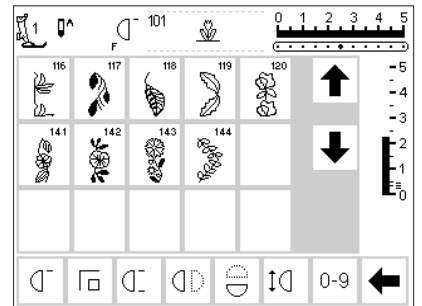
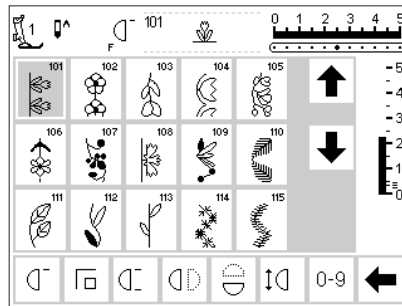
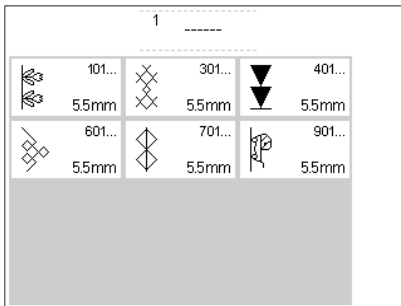

Quilt stitches

Alphabets

Presser feet

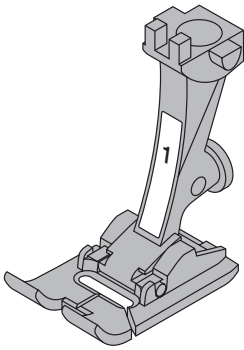

1
Reverse pattern foot with code
Practical and decorative stitches

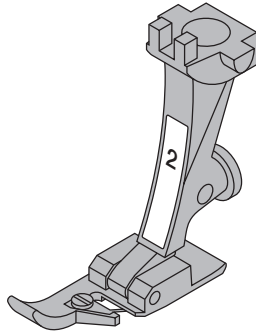

2
Overlock foot
Overlock seams, hems, oversewing edges, narrow satin stitch

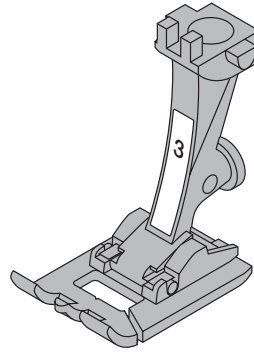

3
Buttonhole foot
Buttonholes

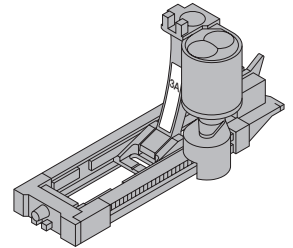

3A
Automatic Buttonhole foot
Buttonholes in flat materials, Darning program

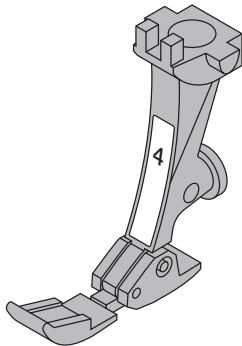

4
Zipper foot
Sewing in zippers

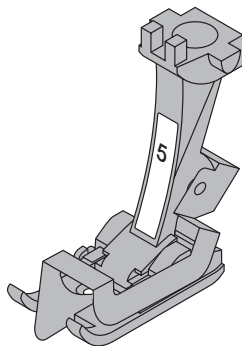

5
Blind stitch foot
Blind hems
Edge stitching

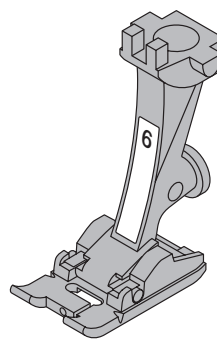

6
Embroidery foot
Embroidery, applique, satin stitch seams, monograms

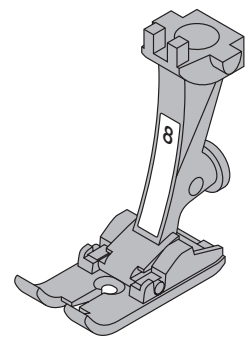

8
Jeans foot
Straight stitching in thick, firm fabrics and over seams

BERNINA Special Presser Feet

The standard selection of presser feet covers most normal sewing requirements but we recommend the use of **BERNINA** specialty feet for specific sewing tasks such as quilting, heirloom sewing, home decorating, tailoring, etc.

They are available from your **BERNINA** dealer.

Samples of Specialty Presser Feet

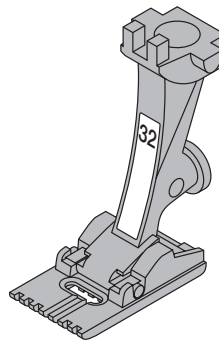

32
Pintuck foot with 7 grooves
Used with a 2 mm double needle to stitch pintucks on medium weight fabrics such as fine wool and cotton

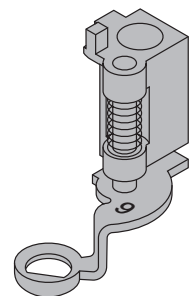

9
Darning foot
Use with the feed dogs in a lowered position for darning, monograms, and freehand embroidery

Practical stitches



1 Straight stitch

All non-stretch fabrics. All straight stitch work.



11 Super stretch

Open seam in all super-stretch fabrics such as Lycra,



2 Zig-zag

Most fabric types. All simple zig-zag applications such as oversewing fine fabrics, attaching elastic, lace and appliqué.

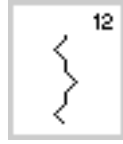

12 Gathering stitch

Most types of fabric. Gathering with shirring elastic. Butted seams (edge to edge).



3 Vari-overlock

Primarily for fine jerseys, stretch overlock seams and hems.



13 Stretch overlock

Medium weight knits, toweling and firm wovens. Overlock seams, flat joining seams.



4 Running stitch

Most types of fabric. Mending, patching, reinforcing seams.

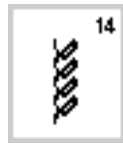

14 Jersey stitch

Natural, blended or synthetic fabrics and delicate knits. Visible seams and hems. Mending jersey/interlock.



5 Securing stitch

All types of fabric. Secures the beginning and end of seams sewn with straight stitch.



15 Universal stitch

Firm fabrics such as felt and leather. Flat joining seams, visible seams, sewing on elastic, decorative seams.

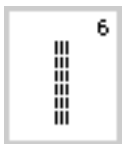

6 Triple straight stitch

Reinforced seams in tough, heavy fabrics.

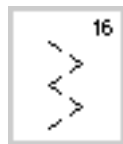

16 Sewn-out zig-zag

Oversewing woven fabrics, reinforcing edges, attaching elastic, decorative seaming.



7 Triple zig-zag

Reinforced seams in firm fabrics, visible hems and seams, decorative stitching, couching.



17 Lycra stitch

All two-way stretch fabrics, flat joining seams and hems, reinforced seaming on underwear.



8 Honeycomb stitch

Most types of interlock and smooth fabrics. Visible seams and hems.



18 Stretch stitch

All stretch fabrics, open seam in sportswear.

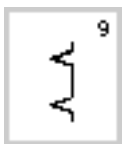

9 Blind stitch

Most types of fabric. Blind hems, shell edging on soft jerseys and fine fabrics, decorative seams.

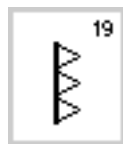

19 Reinforced overlock

Medium to heavy weight knits and toweling, overlock seams, flat joining seams.

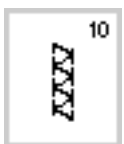

10 Double overlock

All types of knit. Sews and finishes edges in one operation.

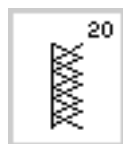

20 Knit overlock

All knits, machine or hand sewn. Overlock = sew and neaten in one.



- 21 Basting**
Basting seams, hems, etc.

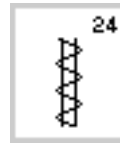

- 24 Bar tack program**
Reinforcing pocket edges, belt loops etc.

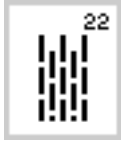

- 22 Simple darning program**
Automatic darning in fine and medium weight fabrics.

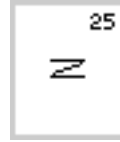

- 25 Bar tack program**
Reinforcing pocket edges, belt loops etc.



- 23 Reinforced darning program**
Automatic darning in heavy weight fabrics.

For more information on using various practical stitches, refer to the *artista 165 Sewing Manual*, pages 2–20.

Buttonholes



- 51 Standard buttonhole**
Fine to medium weight fabrics.
Blouses, shirts, trousers, bedlinen, etc.



- 57 Keyhole buttonhole with pointed bartack**
For non-stretch firm fabrics.
Jackets, coats, leisure wear.



- 52 Standard buttonhole narrow (heirloom)**
Fine to medium weight fabrics.
Blouses, shirts, dresses, trousers, children's and baby clothes, doll clothes and heirloom.

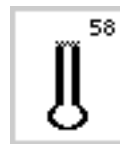

- 58 Keyhole buttonhole with horizontal bartack**
For firm, non-stretch fabrics.
Jackets, coats, leisure wear.

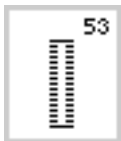

- 53 Stretch buttonhole**
All stretch fabrics made from cotton, wool silk and synthetic fibers.

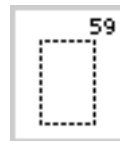

- 59 Straight stitch buttonhole**
For reinforcing satin stitched buttonholes, making bound buttonholes, and stitching buttonholes leather or imitation suede.



- 54 Round buttonhole with normal bartack**
For medium to heavy weight fabrics of all types. Clothing, jackets, coats, rainwear.



- 60 Button sewing on program**
For buttons with 2 and 4 holes.



- 55 Round buttonhole with horizontal bartack**
For medium to heavy weight fabrics of all types. Clothes, jackets, coats, rainwear.

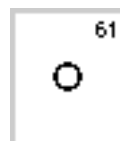

- 61 Narrow zig-zag eyelet**
Opening for cords and narrow ribbons/bands, decorative work.

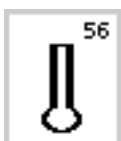

- 56 Keyhole buttonhole with normal bartack**
Heavy weight, non-stretch fabrics.
Jackets, coats, trousers, leisure wear, etc.

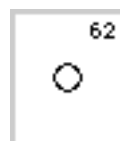

- 62 Straight stitch eyelet**
Opening for cords and narrow ribbons.

For more information on stitching various types of buttonholes, refer to the *artista 165 Sewing Manual*, pages 21–30.

Screen

The artista is operated with a combination of external buttons and knobs and a touch screen.

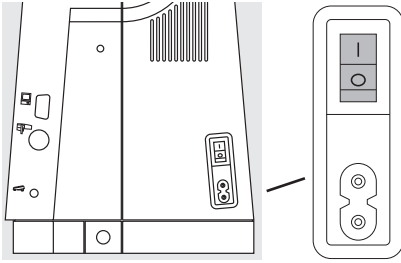

Switch machine on

- power switch to "1"



Welcome screen

- welcome
- appears for approximately 3 seconds
- can be omitted in the Setup program

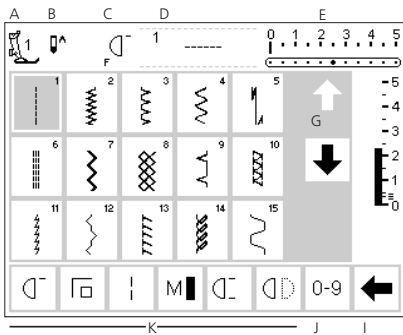

Practical stitch screen

- the practical stitch screen appears immediately after the welcome
- screen shows:
 - A – presser foot indicator
 - B – needle stop position
 - C – assigned "F" button function
 - D – selected stitch and number
 - E – stitch width (basic setting always visible)

- F – needle position (11 possibilities)
- G – up/down scroll arrows
- H – stitch length (basic setting always visible)
- I – scroll arrows for functions
- J – stitch selection with numbers (selected stitch is highlighted)
- K – functions

On screen stitch selection/stitch display/functions

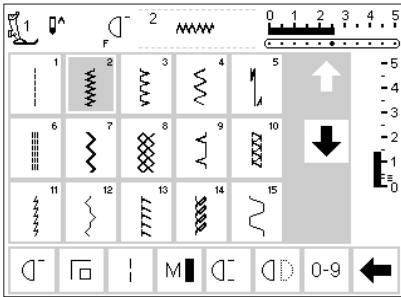

Select a stitch

- touch the stitch of your choice
- the stitch is highlighted
- every stitch is displayed with its number



Altering the needle position



- press the right or left needle position button
- each press moves the needle one point to the right or left

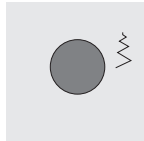

Altering the stitch width

- turn the upper knob



- altered width is shown on the stitch width bar (basic setting visible)
- stitch is displayed with altered setting
- the stitch width can be altered from 0–5.5 mm
- stitch width bar automatically shows 0–5



Presser foot indicator

- the recommended presser foot is displayed by number

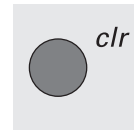

Return to basic settings

- press the external clr button
- the stitch will revert to its basic settings

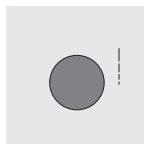

Altering the stitch length

- turn the lower knob

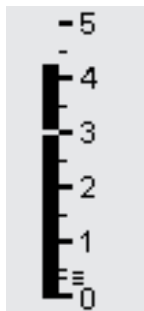

- altered length is shown on the stitch length bar
- the basic setting will be visible (shown at 3mm)
- stitch length can be altered from 0 mm to 5.5 mm on most stitches



Needle stop adjustment

- press the needle stop button
- arrow points down
- the machine always stops with the needle down
- press needle stop button again – needle stop reverts to up (arrow points up)



Display of selected stitch (to the left of stitch width bar)

- the stitch number is always visible in the center of the upper portion of the screen
- stitch number is displayed to the top left of the stitch graphic in the center of the upper portion of the screen



Selecting functions

- touch the function of your choice
- the selected function is highlighted (a number of different functions can be selected simultaneously)
- touch the function toolbar arrow to scroll more functions
- activate another function if desired
- touch the toolbar arrow to scroll again
- the toolbar can be customized in Setup
- for more information functions, see pages 22–28

Stitch selection

Stitches can be selected using one of the two methods listed below.

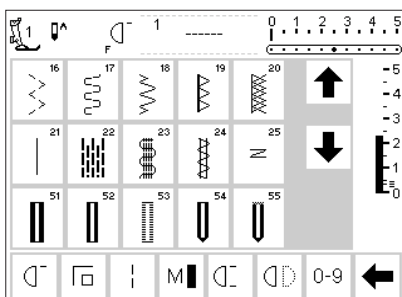

Direct selection by scrolling up/down

- touch the arrow (down)
- scroll the screen to view all stitches
- the top row disappears
- the next two rows move up
- a new row appears at the bottom
- touch the arrow (up)
- the first row of stitches appears again

- the scroll function (up/down) is used to find and view all the machine's stitches
- use when a visual search for a particular stitch is needed when the desired stitch is located, touch it to select

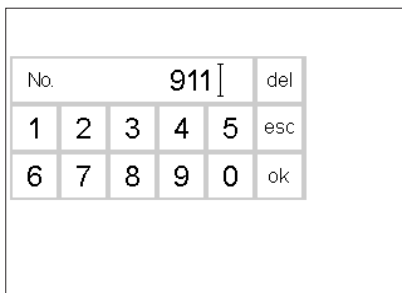

Select a stitch by number

- touch the function "0-9"
- the screen changes to stitch numbers
- touch numbers to select the stitch of your choice
- the number of the selected stitch appears in the top row

Correct

- to correct mistakes or deselect, touch del top right
- the cursor moves to the left and deletes the number
- select new number

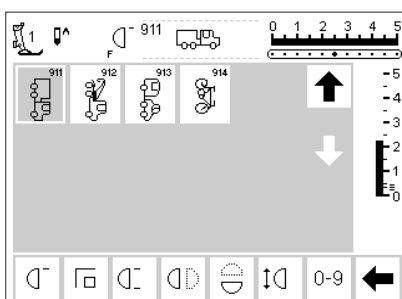

Confirm and go to next screen

- touch OK to confirm
- touch esc
- the screen displays the selected stitch
- the selected stitch is active (highlighted)

- the stitch selected by number will be ignored

Note:

The screen does not react if an unavailable stitch number is entered.

Back to previous screen

- touch esc
- the previous screen appears

Simple menu selection

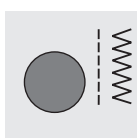

Practical stitches



Buttonholes

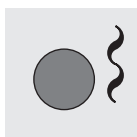

Decorative stitches

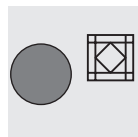

Quilt stitches

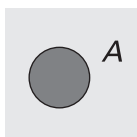

Alphabets

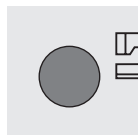

Embroidery

External menu buttons

- press a button
- the program is selected
- the first stitch/stitch program or stitch summary appears on the screen

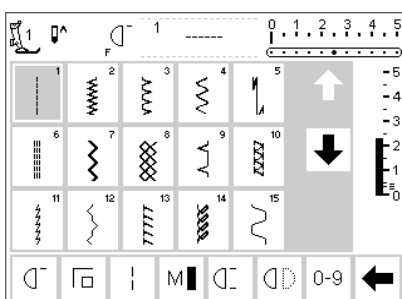

Practical stitch button

- the practical stitch menu appears
- straight stitch top left is active
- 15 practical stitches appear on the screen
- use arrows to scroll for viewing additional stitches

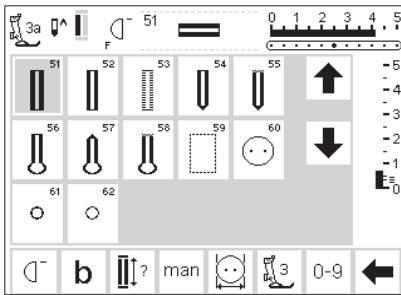

Buttonhole button

- the buttonhole menu appears, including the eyelet and button sew-on programs

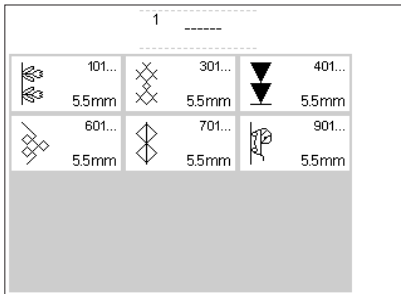

Decorative stitch button

- the decorative stitch menu appears
- pattern types can be selected
- 5.5 mm decorative stitches
- touch to select the desired stitch group
- the selected stitch group appears

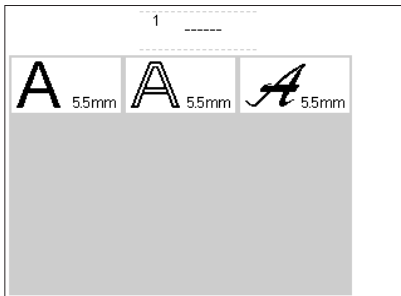

Alphabet button

- the alphabet menu appears
- touch to select the alphabet of your choice

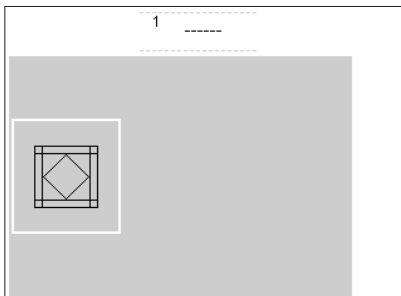

Quilt stitch button

- the menu appears
- touch symbol to activate quilt stitches

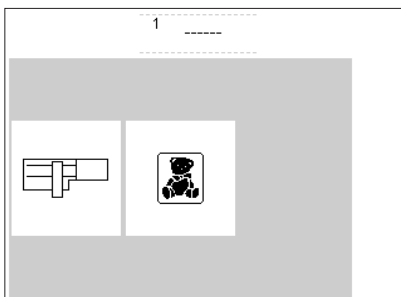

External connections

- the following accessories can be connected to the machine
- embroidery module
- embroidery cards
- menu appears
- touch to select

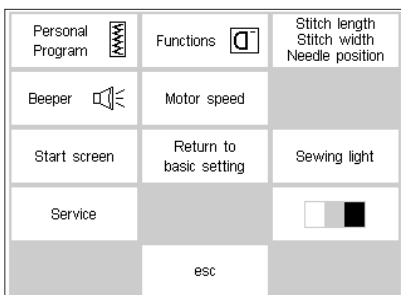

Setup

- press the external Setup button
- menu appears
- use Setup to customize your machine's settings
- stitches and functions can be combined to form a customized (Personal program) menu
- customized menu (Personal program) can be saved

- saved customized menu (Personal program) can be opened at any time
- customized settings can be cancelled at any time

External function buttons

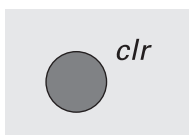

clr (Clear) button

- press the clr button
- stitch length, width and needle position will be returned to basic settings
- most functions will be deleted (see individual functions)

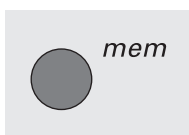

mem (Memory)

- press the mem button
- memory is open and appears on the screen
- the memory bar replaces the third row of stitches on the screen
- see chapter on Memory
- press mem button to close
- for more information on using the memory, see pages 38–43

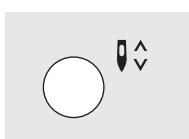

Needle stop adjustment

- the default setting of the needle is in the "up" position
- press the needle stop button
- the on-screen arrow points down
- the machine will always stop with needle down
- press the needle stop button again to revert to needle stop up

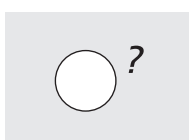

"?" (Help)

- press the Help button
- touch a stitch or function
- explanation for the selected stitch or function appears

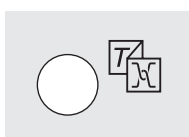

TC (Tutorial/Sewing Consultant)

- press the button
- menu appears
 - *Tutorial* (instructions in brief)
 - *Creative Consultant* (advice on fabric/needle/techniques)
- touch to select the desired menu
- the information selected is activated and the appropriate screen will appear

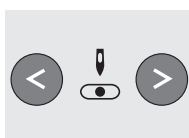

Needle position

- press the left or right needle position button
- the needle moves to the right or left
- total of 11 needle positions: 5 left, 5 right, center

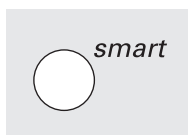

Smart button

- press the Smart button
- the stitch is saved with all adjustments to width, length, and needle position
- select a new stitch, e.g. button-holes
- press the Smart button to return to the previous screen with saved settings
- use the Smart button to toggle between stitches as you work

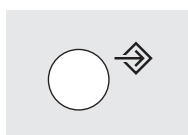

Setup

- press Setup
- menu appears
- use Setup to customize your machine's settings
- stitches and functions can be combined to form a customized menu (Personal program)
- customized menu (Personal program) can be saved
- saved customized menu (Personal program) can be opened at any time
- customized settings can be cancelled at any time

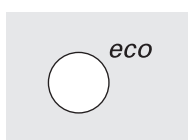

eco (ecology) button

- press the eco button
- energy use by the machine is cut by 50%
- particularly useful for long interruptions in work
- all settings remain active; foot control is inactive
- screen saver is activated
- press the eco button again to restore the sewing machine to normal function

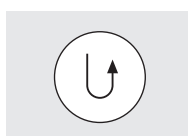

Quick reverse button (above needle)

- press the quick reverse button
- secure the seam beginning and end – sews in reverse as long as button is depressed
- used to program buttonhole length
- used to program darning length
- used to switch to straight stitch securing program (Stitch no. 5)
- used to start/stop stitching with the embroidery module (special accessory)

**Single Pattern (above needle)**

- press the pattern end button
- machine stops at the end of the next stitch pattern sewn

**F (Favorite function) button (above needle)**

- this button can be individually programmed in Setup with a function of your choice
- selected function can be cancelled and reprogrammed at any time with another function
- personal program can be programmed into "F" button
- for more information on the Favorite function button, see page 54

On-screen functions

Fields are highlighted when functions are activated.

Activated functions can be cancelled individually by pressing a second time.

All selected functions can be cancelled simultaneously by pressing the external clr button.

Exceptions:

Needle stop and Double needle limitation.
These functions must always be cancelled individually.

General functions

The following functions are found on various screens and programs of the **artista** sewing machine. They are consistently

**Scroll up**

- touch one or more times
- screen scrolls up to show more options
- touch the symbol continuously to scroll quickly

**Scroll down**

- touch one or more times
- screen scrolls down to show more options
- touch the symbol continuously to scroll quickly

used in the same manner for specific tasks when accessing and moving between different programs.

Closing special applications

- touch esc
- the special application closes
- returns to previous screen

OK

- touch to confirm and activate adjustment/selection, e.g. thread tension change
- programmed adjustment/selection is ready to sew

Function toolbar

The following functions are available on the **artista** sewing machines. Any function which can be used in the selected program will appear on the screen in the bottom row. If there are more than eight (or four memory



Complete function toolbar as it appears in the practical stitch program.

functions), the remaining ones will be hidden and can be accessed by using the arrow in the lower right corner to scroll. When a hidden function is active, the arrow will flash.



Hidden functions that can be accessed by scrolling with the arrow.

Note: The scroll arrow and the 0–9 (stitch selection by number) will remain on the screen for easy access and will

never be hidden. A total of eight functions (or four regular and four memory functions) will shown on-screen.



Pattern begin

- touch symbol
- the needle moves to the beginning of a stitch or stitch combination
- field is highlighted but reverts to normal after 2 seconds or after beginning to sew
- if selecting Pattern begin for a memory combination, the cursor will appear to the *right* of the first stitch on-screen

Applications:

- embroidery, buttonholes, working in memory



Securing

- touch symbol
- individual stitches will be secured at the beginning and end with 4 stitches
- securing in memory: stitch and letter combinations will be secured at the beginning and end

Applications:

- sewing individual decorative stitches
- sewing individual letters
- sewing stitch combinations and words



Long stitch

- touch symbol
- machine sews every second stitch (max. stitch length 10 mm)
- can be activated for all practical and decorative stitches *except* buttonholes
- functions and stitches can be combined
- can be saved in memory
- does not operate with the embroidery module (special accessory)

Applications:

- combine with straight stitch to baste
- combine with triple straight stitch for topstitching



Motor speed $\frac{1}{4}$, $\frac{1}{2}$, $\frac{3}{4}$, $\frac{1}{1}$

- touch symbol one or more times to select speed
- selected speed is displayed
- reduces or increases the motor speed
- will sew the selected maximum speed with the foot control fully depressed

Applications:

- adjust speed for decorative sewing machine work such as freehand embroidery or freehand quilting and when more control is desired for the sewing task
- when children are sewing



Pattern end 1–9

- touch symbol one or more times to select number required
- 1 = machine stops at the end of an individual stitch or stitch combination
- 2–9 = machine stops at the end of a stitch or stitch combination after the number of repeats selected

Applications:

- sewing individual motifs
- combine with practical stitches and decorative sewing



Horizontal mirror image

- touch symbol
- machine sews selected the stitch in horizontal mirror image (left/right – determined by the sewing direction)
- can be saved in memory

Applications:

- decorative stitching
- pattern combinations in memory

0-9

Stitch selection by number

- touch number symbol
- select stitch by touching the appropriate number combination

Applications:

- quick selection of individual stitch
- quick selection for stitch combination in memory

**Scroll**

- touch one or more times to view more functions

Applications:

- view all available functions
- combine functions with stitches for individual motifs or in memory

**Vertical mirror image**

- touch symbol
- machine sews selected stitch in vertical mirror image (up/down – determined by the sewing direction)
- can be saved in memory

Applications:

- decorative stitching
- pattern combinations in memory

**Pattern extension 2–5x**

- touch one or more times
- the numbers 2–5 appear depending on the type of stitch selected
- the length of selected stitch will be increased by 2–5 times
- lengthened stitches can be programmed in memory

Applications:

- lengthen existing patterns without affecting the stitch density
- combine stitches

**Double needle limitation**

- touch one or more times to select number from 2 to 5
- the numbers represent the distance between the needles in mm
- the stitch width will be limited automatically
- this prevents the needles from hitting the presser foot or stitch plate, avoiding needle breakage
- can be saved in memory

Applications:

- sewing pintucks
- hemming knits
- decorative stitching

Note: There is one additional function, Hemstitch Needle Limitation, available for placement on the function toolbar (see Functions in Setup, page 26). This can be placed on the toolbar using the Setup program (see page 54).

**Continuous reverse sewing**

- touch symbol
- sews the selected stitch in reverse

Application:

- darning with straight or running stitch
- decorative stitching on sleeves or trouser legs
- quilting

**Half pattern**

- touch symbol
- machine automatically stops at the halfway point of the stitch pattern
- when stitching is resumed, the pattern is completed and the first half of the next pattern is stitched before the machine automatically stops again
- use Single pattern to stop at the end of the second half of the stitch pattern

Application:

- turning corners
- altering decorative stitches for a new look

**Balance**

- touch symbol to open balance screen
- correct forwards and reverse stitches

Applications:

- adapting practical and decorative stitches to various types of fabrics
- altering decorative stitches for a new look
- adapting buttonholes to different fabrics

**Clear All**

- clears all settings that were changed *except* those that were changed using the Setup program
- returns to default settings
- Settings affected:
 - Continuous Reverse
 - Long Stitch
 - Pattern End
 - Securing Function
 - Horizontal Mirror Image
 - Vertical Mirror Image
 - Pattern Extend
 - Balance
 - Stitch Length
 - Stitch Width
 - Needle Position
 - Half Pattern
 - Double Needle Limitation
 - Hemstitch Needle Limitation
 - Needle Stop Position
 - Motor Speed
 - Alphabet Size
 - Stored Buttonholes

Functions in Setup

The functions below are found in the Setup program of the **artista** sewing machine. They are accessed by pressing the external Setup button on the front of the machine and then

touching Functions on the screen. These functions are used when setting the features and functions of the machine to your personal requirements.

Pers.
Pro.

Personal program

- touch symbol
- personal screen appears

Applications:

- quick method to open personal program

reset

Reset

- touch symbol
- personal settings are reverted to basic settings



Delete functions

- touch symbol
- delete functions



Insert functions

- touch symbol
- insert functions

The function below is available in the Setup program of the **artista** sewing machine. It is a sewing function used from the sewing screens; however, it will not show up on

the toolbar at the lower edge of the screen unless specifically placed there. For more information, see pages 53–55.



Hemstitch (wing) needle limitation

- will not show up on the toolbar unless it is inserted by the user
- can be installed in the Setup program
- the stitch width is limited automatically
- needle position limited to center
- prevents the needle hitting the presser foot or stitch plate – no needle breakage

Application:

- hemstitching
- decorative stitching

Functions in Memory

check

Check

- touch symbol
- memory contents are displayed

Application:

- check and correct memory contents

del

Delete

- touch symbol
- delete individual stitches or letters to the left of the cursor
- delete stitch combinations

Application:

- corrections in memory
- delete complete memories

mem
1

Select memory

- the opened memory is displayed with its number
- touch to display the contents of the memory bank
- touch esc to close memory bank
- press the external mem button to close memory

Applications:

- working in memory
- saving stitch combinations

store

Store

- touch symbol
- saves individual stitches, stitch combinations and letters in memory

Applications:

- saving programs



Scroll left

- touch symbol one or several times
- memory contents are scrolled backwards

**Scroll right**

- touch symbol one or several times
- memory contents are scrolled forwards

edit

Edit memory contents

- touch symbol
- correct, edit stitches, letters or numbers to the left of the cursor
- insert functions, mirror image
- touch symbol again to close edit screen

Applications:

- correcting, changing memory contents

Functions in Editing

The following functions become available in the center of the screen when the edit function is selected. All functions on the toolbar (except del) will become inactive

when the edit function is selected and will reactivate when the edit function is closed.

**Motor speed**

- touch symbol one or more times to select speed
- selected speed is displayed
- full speed is 880 stitches per minute (unless the basic setting has been changed in the Setup program)
- reduces or increases the sewing speed $\frac{1}{4}$ at a time ($\frac{1}{4}$, $\frac{2}{4}$, $\frac{3}{4}$, $\frac{4}{4}$)

**Securing function**

- touch symbol
- the end of the last stitch in the memory will be secured with 4 tiny stitches

**Memory sub-division**

- touch symbol
- the memory has up to 255 sections or banks
- each bank can be subdivided as desired
- total memory (all banks together) holds 1023 stitches

**Long stitch**

- touch symbol
- machine sews every second stitch (max. stitch length 10 mm)

**Horizontal mirror image**

- touch symbol
- machine sews selected stitch in horizontal mirror image
- alteration of selected stitch is shown on-screen

**Vertical mirror image**

- touch symbol
- machine sews selected stitch in vertical mirror image
- alteration of selected stitch is shown on-screen

**Pattern Extend 2-5x**

- touch one or more times
- the numbers 2-5 appear depending on the type of stitch selected
- the length of selected stitch will be increased by 2-5 times
- the stitch density is not affected
- lengthened stitches can be programmed in memory

**Balance**

- touch symbol to open balance screen
- correct forwards and reverse stitches

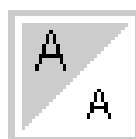
**Letter size**

- touch one or more times
- one half of field is highlighted
- the gray section visually indicates the letter size: large (5,5 mm) or small (4 mm)

Buttonhole program functions

The functions below appear on the function toolbar at the lower edge of the screen when any buttonhole (stitches 51–62) is selected.

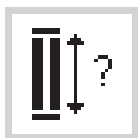

Buttonhole length – direct length entry

- touch symbol to open number screen
- Buttonhole length = buttonhole opening in mm

Application:

- use this method if you know the size of your button

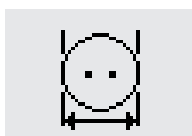

Buttonhole length – on screen measurement

- touch symbol to open measuring screen
- hold button to bottom lower left corner of screen and use the stitch width knob to measure it
- buttonhole length will be programmed with 2mm added automatically

Application:

- simple method to determine buttonhole size



Manual buttonhole

- touch symbol
- follow procedure (4–6 steps, depending on buttonhole type)

Application:

- for individual manually sewn buttonholes
- to repair existing buttonholes



Stitch counter buttonhole

- select buttonhole
- touch symbol
- stitch counter buttonhole will be activated

Alphabet program functions

The following functions will appear in the lower left corner of the screen when a letter of an alphabet is

selected. It will reduce the number of normal functions shown on the toolbar by one, causing it to be hidden.

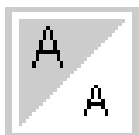

Letter size

- appears in toolbar when any letter or character of one of three styles of alphabets is selected
- touch one or more times
- one half of field is highlighted
- the gray section visually indicates the letter size: large or small

Applications:

- size selection
- works in memory (letters do not have to be reprogrammed but can be resized using the edit function)

Messages

The following messages may appear on the screen of the **artista** sewing machine during certain operations. They are reminders, warnings, or confirmations about the function or stitch being selected. Below is a list

MESSAGE

Please check the upper thread.

The bobbin winder is on.

Do you really want to delete the contents of this memory?

Personal Program memory is full.

Memory is full.

of the messages pertaining to the sewing machine (see embroidery manual for messages that pertain to the embroidery module) and the appropriate responses.

RESPONSE

Check to see if the needle thread has run out or has broken. Rethread the needle thread if needed. Machine will not sew until this is corrected.

Check to see if bobbin winder is on. If the bobbin winder is on, the foot pedal is inactive and the machine will not sew. Disengage the winder if needed. Machine will not sew until this is corrected.

Note: This message will appear when winding a bobbin; touch esc to clear it from the screen.

Confirms the delete command before any stitches or functions are erased from memory. Touch OK to continue with the deletion process; touch esc to abort the process.

To save a stitch, an already saved stitch must be deleted.

To save a stitch, an already saved stitch must be deleted.

Buttonholes

Buttonholes are practical closures which can also be used for a decorative effect. The **artista** 165 provides a very versatile selection.

All buttonholes can be sewn and programmed in a variety of ways.

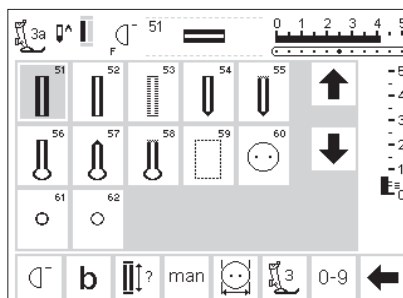

Buttonholes/Button sewing on program/eyelets

- press the external Buttonhole button (to the right of screen)
- screen shows an overview of all buttonhole and eyelet types
- 51 standard
- 52 narrow (heirloom)
- 53 stretch
- 54 round with normal bartack
- 55 round with horizontal bartack
- 56 keyhole with normal bartack
- 57 keyhole with pointed bartack
- 58 keyhole with horizontal bartack
- 59 straight stitch buttonhole

- 60 button sew-on program
- 61 zig-zag eyelet
- 62 straight stitch eyelet

Select buttonhole/button sew-on program/eyelet

- touch symbol
- selected buttonhole, eyelet or button sew-on program is activated
- If one of the buttonholes (51–62) is activated, all functions are reset to the default settings

The following buttonholes and related stitches are found on the buttonhole screen.

For additional information on uses for each type, see page 17.



51 Standard buttonhole

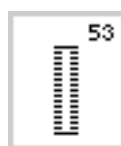

53 Stretch buttonhole



55 Round buttonhole - horizontal bartack

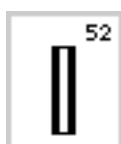

52 Narrow buttonhole (heirloom)

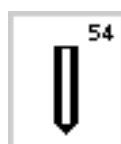

54 Round buttonhole - normal bartack

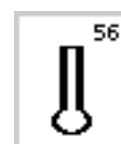

56 Keyhole buttonhole - normal bartack

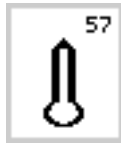

57 Keyhole buttonhole – pointed bartack

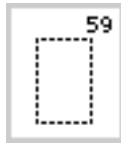

59 Straight Stitch buttonhole

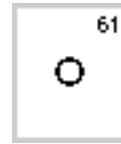

61 Eyelet – narrow zigzag

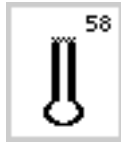

58 Keyhole buttonhole – horizontal bartack



60 Button Sew-on program

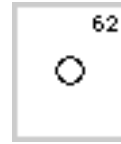

62 Eyelet – straight stitch

Automatic buttonholes (standard and stretch)

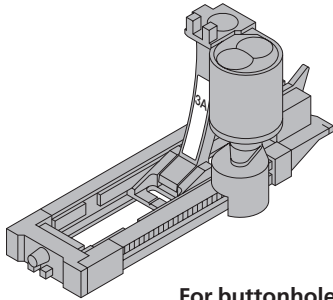

For buttonhole example, refer to the artista 165 Sewing Manual, page 25.

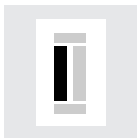

Sewing the first bead

- the sewn section will be displayed on the screen (to the right of the presser foot indicator)
- sew the first bead forwards, stop the machine at the desired length

Both beads are sewn in the same direction.

Buttonhole length = buttonhole opening in mm

Note: the automatic buttonhole foot 3A must lie flat on the fabric, i.e. not on a seam allowance, otherwise the length will not be measured accurately.

Automatic buttonhole

- the lens on the buttonhole foot 3A will register the length that you determine automatically
- for making buttonholes from 4–29 mm length

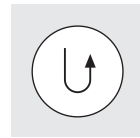

Programming the buttonhole

- press and release the quick reverse button
- auto appears in buttonhole symbol = length is programmed
- machine sews straight stitch backwards



Auto buttonhole

- machine sews first bartack automatically
- machine sews second bead forwards



- machine sews second bartack automatically
- machine sews securing stitches automatically
- machine stops and returns automatically to the beginning of the buttonhole
- all subsequent buttonholes will be sewn automatically to the same length (without pressing the quick reverse button)

Buttonhole Leveler (optional accessory)

When sewing a buttonhole using Automatic Buttonhole Foot No. 3A on an uneven area (such as over a seam allowance), use the Buttonhole Leveler. This accessory will create a smooth surface for the foot and help make a perfect buttonhole.

Automatic buttonholes (round and keyhole)

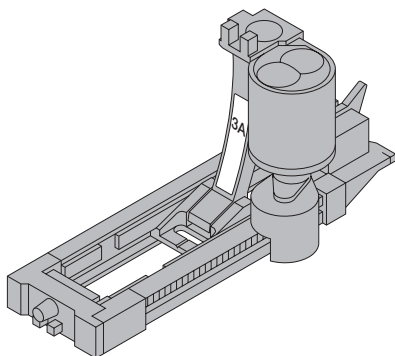

Both beads of the buttonhole are sewn in the same direction.

Buttonhole length =
buttonhole opening in mm

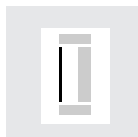

Sewing the first straight stitches

- the sewn section will be displayed on the screen (to the right of the presser foot indicator)
- sew straight stitches forwards, stop the machine at the desired length

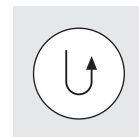

Programming the buttonhole

- press the quick reverse button
- when auto appears under the buttonhole symbol, the buttonhole is programmed
- machine stops and returns automatically to the beginning of the buttonhole
- all subsequent buttonholes will be sewn automatically to the same length (without pressing the securing button)

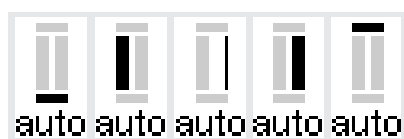

Note: The graphics shown on the screen are the same as for a standard buttonhole (see above) when stitching a round or keyhole buttonhole

For buttonhole example, refer to the artista 165 Sewing Manual, page 26.

Auto buttonhole

- machine sews circle or eye automatically
- machine sews the first bead backwards automatically
- machine sews straight stitches forwards up to circle or eye
- machine sews 2nd bead backwards automatically
- machine sews bar tack automatically
- machine sews securing stitches automatically

Automatic buttonhole (all types)

Direct entry length

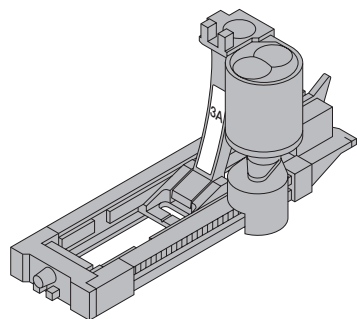

If the desired length of a buttonhole is known, it can be directly entered into the machine (in millimeters).

When using the Automatic buttonhole foot No. 3A for stitching keyhole buttonholes, the maximum length that should be entered is 24 mm. That leaves room for the keyhole, which the machine will add automatically.

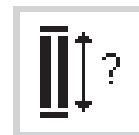

Open number screen

- buttonholes can be sewn to a specific length with the automatic buttonhole foot 3A
- select type of buttonhole
- touch buttonhole with question mark symbol



Enter the length

- numbers 1–0 appear on the screen
 - enter the buttonhole length (4–29 mm) with numbers
 - the length appears to the right of the buttonhole symbol
 - touch OK to confirm, screen changes automatically
- Buttonhole length =
buttonhole opening in mm

Corrections:

- touch del to delete wrong numbers

Back to buttonhole menu

- touch esc



On-screen display

- "auto" below the buttonhole symbol indicates that the buttonhole is programmed

Automatic buttonhole (standard and stretch)

Length calculated from button

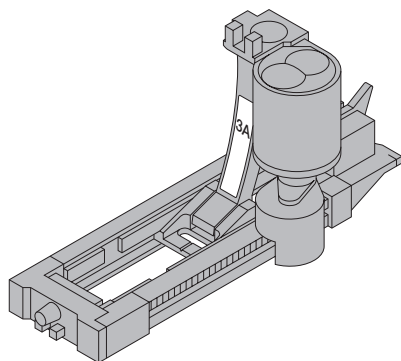

The buttonhole size can be determined by holding a button on the screen. The length will be determined by the machine and displayed on the screen.

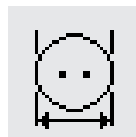

Open calculation screen

- select buttonhole
- touch button size function

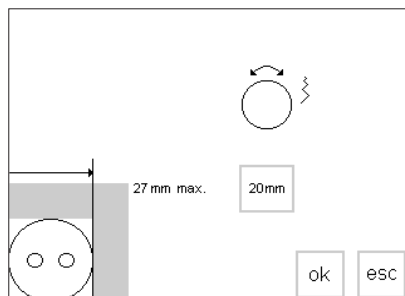

Determine button size

- a scale appears on the screen
- hold the button (4–27 mm) against the bottom left corner of the screen
- use the external stitch width knob to move the vertical line on the screen, changing the size of the box around the button
- the buttonhole size is shown in mm on the right, e.g. 20 mm

Back to buttonhole menu

- touch OK to confirm and return to buttonhole screen

Buttonhole size

- the computer calculates the buttonhole size from the button diameter
- 2 mm are added automatically to take the bartacks of the buttonhole into account

Corrections for thick buttons

- for buttons which are particularly thick, e.g. raised buttons etc., do not move the vertical line right up to the edge of the button
- move it to within about 1–4 mm of the right edge of the button, depending on the button height

Recommendation

- sew a test buttonhole on a scrap of the fabric and interfacing you intend to use
- cut buttonhole open
- push button through hole
- correct the size if necessary

Stitch counter buttonholes (all types)

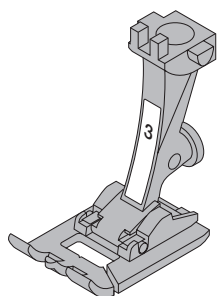

The first bead of the buttonhole is sewn forward and the second, backwards.

Stitch using Buttonhole Foot No.3 or Automatic Buttonhole Foot No.3A; and sew at a consistent speed.

The appearance of a stitch counter buttonhole can vary on different types of fabric so it must be reprogrammed for different fabrics.



Presser foot

- select buttonhole
- touch the presser foot No.3 symbol
- the machine registers that the stitch counter program has been selected

- the buttonhole length is now measured by the stitch counter, i.e. number of stitches

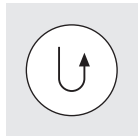
**1st bead length**

- sew the first bead, stopping the machine at the desired buttonhole length

- press and release the quick reverse button on the frame

**Bartack, 2nd bead**

- the machine sews the end of the buttonhole and automatically switches to stitching the reverse bead

- Continue stitching the reverse bead, stopping when the needle is even with the beginning of the buttonhole
- press and release the quick reverse button

**Bartack, securing stitches**

- the machine sews 5 bartack stitches and secures the buttonhole automatically
- auto appears under the graphic of the buttonhole on the screen
- the buttonhole is now programmed
- all subsequent buttonholes will be sewn as programmed

Changes

- the buttonhole must be reprogrammed after altering the stitch length, width, or balance

For buttonhole example, refer to the artista 165 Sewing Manual, page 27.

Buttonhole corrections (all types)

The following adjustments can be made to a buttonhole and will remain in effect until the machine is turned off.

Permanent adjustments can be made using the Setup program (see pages 50–61).

**Buttonhole too wide**

- to reduce the width of the buttonhole, reduce the stitch width

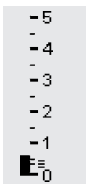
**Bead density**

- increase or reduce the stitch length by approximately 2 steps to achieve the desired effect

**Balancing the beads**

- balance will influence the bead and the eye density
- balance affects both beads and the eye

**Open balance screen**

- select buttonhole
- touch Balance
- balance ↑ to increase the density
- balance ↓ to reduce the density
- sew buttonhole until area to be corrected is reached. Adjust balance. Continue sewing. The correction will be incorporated in all subsequent buttonholes.

Recommendation:

- always test sew on the piece of fabric you intend to use

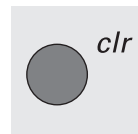
**Delete balance adjustments**

- press clr or touch reset

For additional information about buttonholes, refer to the artista 165 Sewing Manual, pages 21–28.

Buttonhole in Long Term Memory

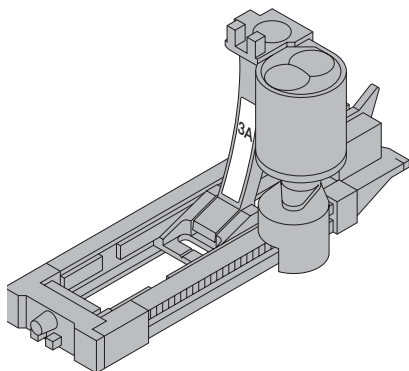

One buttonhole of each type may be saved in special buttonhole memory banks. This does not affect the standard memory of the machine.

Long term saving of buttonhole programs is only possible for buttonholes originally stitched as auto-length buttonholes (see pages 29–32).

Once the length of the buttonhole is determined, the programmed buttonhole can be saved using the store function on the toolbar.

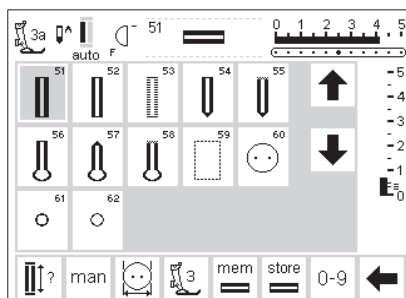

Saving the Buttonhole (Store)

- program the desired automatic buttonhole according to the directions on pages 29–32
- touch store on the function toolbar

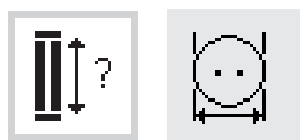

Recalling the Saved Buttonhole

- select the desired buttonhole style
- touch mem
- touch the buttonhole length or button measurement function to recall the saved buttonhole
- the length of the buttonhole will appear on the screen

Changing the Saved Buttonhole

- select the desired buttonhole style
- touch mem
- touch the buttonhole length or button measurement function to recall the saved buttonhole
- change the length, and touch OK to confirm
- touch store
- programming a new length overrides the existing stored one

Manual 4–6 step buttonholes

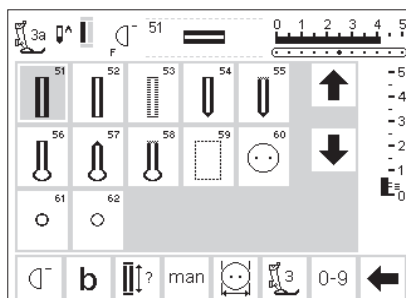

Manual buttonholes are ideal when making single buttonholes or for repairing existing buttonholes. The number of steps depends on the type of buttonhole selected.

Note: A manual buttonhole cannot be saved.

Open buttonhole screen

- select buttonhole
- touch the man function

man

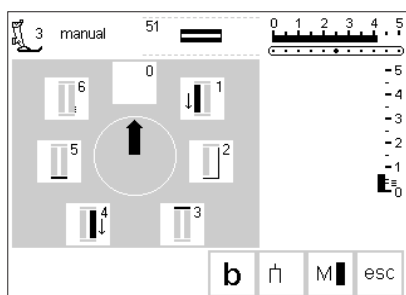

Step symbols

- step symbols appears on the screen for the buttonhole selected
- the arrow in the circle is on "0" when the buttonhole is selected
- standard buttonhole has 6 steps
- round buttonhole has 4 steps
- keyhole buttonhole has 4 steps

For buttonhole example, refer to the artista 165 Sewing Manual, page 28.

Sewing a Four-step Buttonhole (round and keyhole)

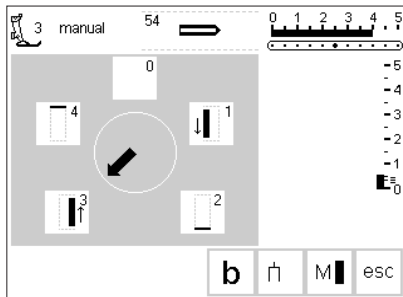

Note:
The graphics shown above will appear on the screen for both the round and keyhole buttonholes.

Sewing a 4-step buttonhole

- touch "1"
- sew the 1st bead
- stop the machine at the desired length
- touch "2"
- machine sews the keyhole or eye
- touch "3"
- machine sews the 2nd bead in reverse
- stop machine at the first stitch
- touch "4"
- machine sews the top bartack and securing stitches before stopping automatically

- length of beads is determined by the user
- bartack, keyhole, and securing stitches are preprogrammed
- use an awl to punch the keyhole before cutting the buttonhole open

Leave program

- touch esc
- screen reverts to buttonhole screen

esc

Sewing a Six-step Buttonhole

Note: The graphics shown on the screen (see below) are the same when stitching the standard, narrow, and stretch buttonholes.

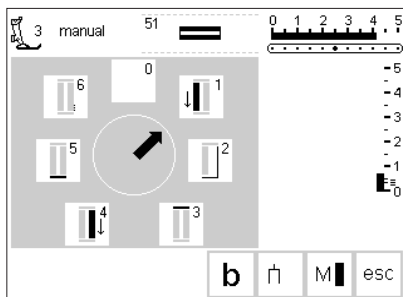

Sewing a 6-step buttonhole

- touch "1" on the screen
- symbol shows section of button to be sewn
- sew the 1st bead
- stop stitching at the desired length

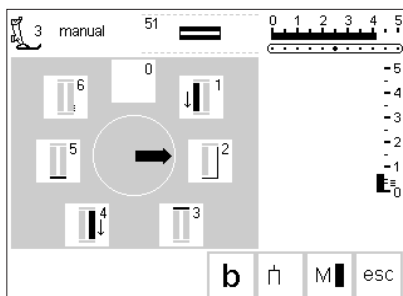

Sewing the buttonhole

- touch "2"
- machine sews straight stitch backwards
- stop machine at the first stitch
- touch "3"
- machine sews the top bartack and stops automatically
- touch "4"
- machine sews the second bead in the forward direction
- stop machine

- touch "5"
- machine sews the bottom bartack and stops automatically
- touch "6"
- machine sews securing stitches and stops automatically
- length of beads is determined by the user
- bartacks and securing stitches are preprogrammed

Leave program

- touch esc
- screen reverts to buttonhole screen

esc

Straight stitch buttonholes

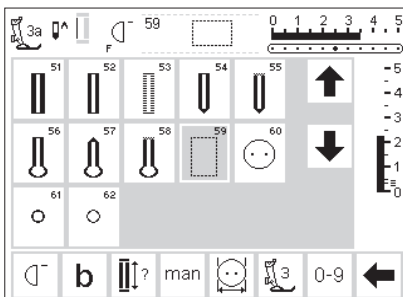

Straight stitched buttonholes are particularly useful for reinforcing satin stitched buttonholes on all soft and loosely woven fabrics such as wool, or for buttonholes which are subject to extreme wear. They are also useful for stitching bound buttonholes and reinforcing buttonhole openings in leather, vinyl, or felt.

- Automatic buttonhole foot No.3A – programming is exactly the same as for the auto buttonhole program (page 29–32)
- Buttonhole foot No.3 – programming is exactly the same as for the stitch counter buttonhole program (page 32–33).

Alter the distance

- alter the stitch width if the distance between the two rows of stitching is too narrow or too wide

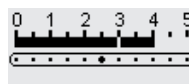

Straight stitched buttonholes

- select stitch No. 59
- the sequence is determined by the presser foot used
- this program functions exactly the same as the corresponding buttonhole program which will be stitched over the straight stitched buttonhole

Cutting buttonholes open

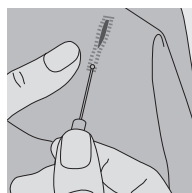

Seam ripper

- use the seam ripper to cut the buttonhole open, starting at each end and working towards the middle

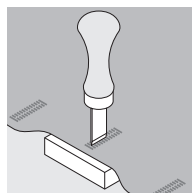

Buttonhole cutter and block

- place the fabric on a piece of wood
- position the cutter in the center of the buttonhole
- press the handle of the cutter to punch the buttonhole

Button sew-on program

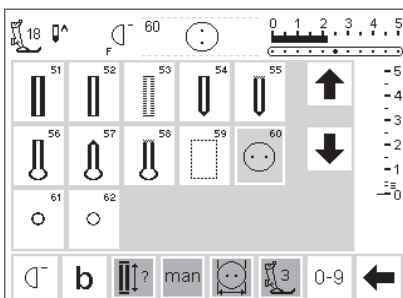

Buttons with 2 and 4 holes can be sewn on by machine.

Button sew-on program

- select stitch 60
- the button sew-on foot No.18 is available as a special accessory
- the distance (shank) between the button and fabric can be adjusted as desired

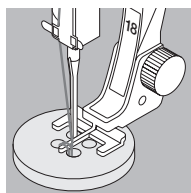

Sew button on

2-hole buttons

- adjust the stitch width if necessary to equal the distance between the holes of the button
- machine stops automatically at the end of the program
- wind thread ends around the thread under the button to create a thread shank

4 hole buttons

- adjust the stitch width if necessary to equal the distance between the holes of the button
- sew the two front holes
- move work forwards
- sew two back holes
- wind thread ends around the thread under the button to create a thread shank

For button sew-on example, refer to the artista 165 Sewing Manual, page 29.

Eyelet program

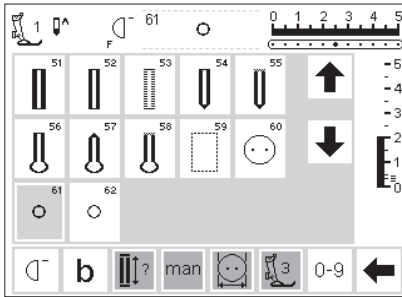

Eyelets

- select eyelet
- 61 zig-zag eyelet
- 62 straight stitch eyelet

Sewing the eyelet

- machine stops automatically at the end of the program

Punching the eyelet

- use an awl to punch the hole in the eyelet

For eyelet examples, refer to the **artista 165 Sewing Manual, page 30.**

Alphabets/numbers

There is a choice of three different alphabet styles.

Each alphabet can be sewn in two sizes.

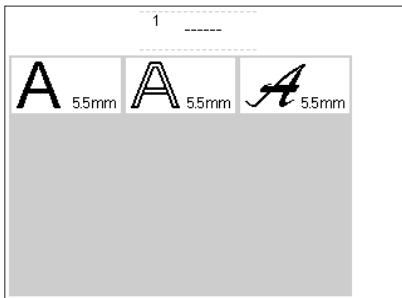

Alphabets

- press the external Alphabet button
- the Alphabet menu appears
- screen shows:
 - Block letters
 - Double block letters
 - Upper case italics
- touch to select the desired style
- the selected style is activated

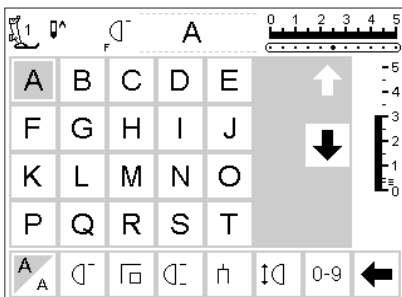

Screen: Letter selection

- the presser foot indicator and needle stop symbol are in the usual positions
- scroll up and down to select letters and numbers

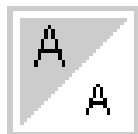

Alter size

- when an alphabet is selected the larger size is activated
- touch symbol
- the highlighted area changes

- this indicates that the smaller size is active
- touch symbol again
- the larger size is now active

For alphabet example, refer to the **artista 165 Sewing Manual, page 43.**

Programming letters/numbers

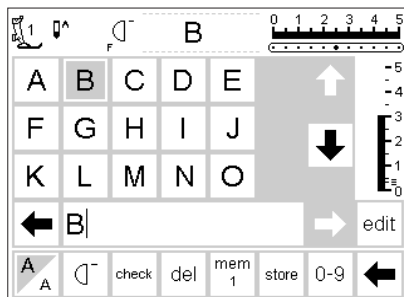

Programming

- open memory
- touch to select letter
- the letter appears in memory
- the cursor moves to the right behind the letter

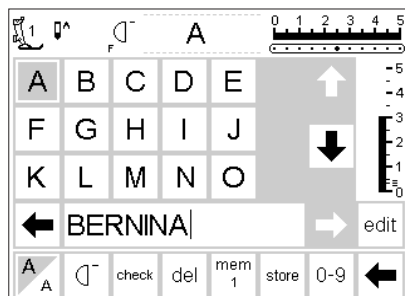

Continue programming

- touch to select the next letter
- the letter appears in memory
- continue in this manner
- for additional information on saving in memory, see pages 38–43

For alphabet example, refer to the artista 165 Sewing Manual, page 43.

Memory

Stitches, letters and numbers can be programmed, saved and corrected in memory.

The memory has a capacity of 1023 stitches that can be divided into 255 memory segments or banks. The memory banks are as large as required, depending on the number of stitches that are saved in each one.

The memory is long-term, i.e. contents remain saved until they are deleted or overwritten. Power disconnections or long periods of non-use do not have any effect on the memory contents.

Any alterations to stitch length, stitch width, and needle position should be made *before* entering the stitch into memory.

In contrast to the stitch menu, selected stitches are shown turned 90° counter clockwise in the memory bar. The sewing direction is always from left to right on the memory bar.

For memory examples, refer to the artista 165 Sewing Manual, pages 41–43.

Open Memory

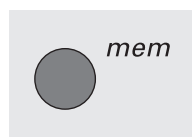

Open Memory

- press the external mem button
- the memory bar appears on the screen
- the third row of stitches disappears from the screen
- scroll up and down to view these and further stitches
- the cursor appears as a vertical line in the memory bar
- all changes (programming, inserting functions, corrections) affect the character to the *left* of the cursor

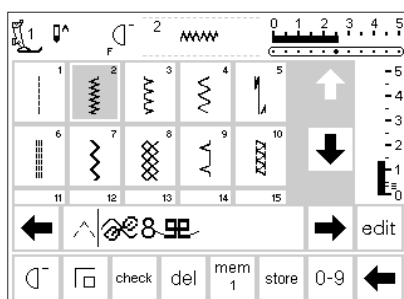

- the function toolbar at the bottom of the screen changes automatically to include those functions appropriate for memory
- the opened memory bank is indicated by its number in the bottom bar

Programming stitches

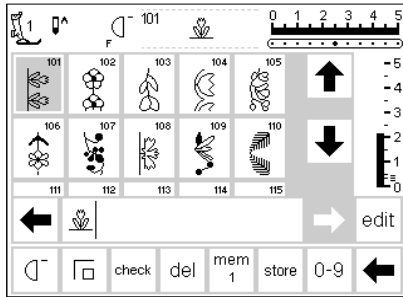

Programming

- select the desired stitch
 - make any desired adjustments to stitch width, stitch length, and needle position
 - open the memory by pressing the external mem button
 - touch mem 1 to access the memory storage screen
- Note:** if the machine has been turned off since the last time the memory feature was used, mem 1

- will show on the screen when the memory is activated. If the machine has *not* been turned off, the last memory bank opened will show.
- select an empty memory bank
- touch OK to return to the previous screen
- select the desired stitch
- the stitch appears in the mem field
- the cursor moves to the right as stitches are selected

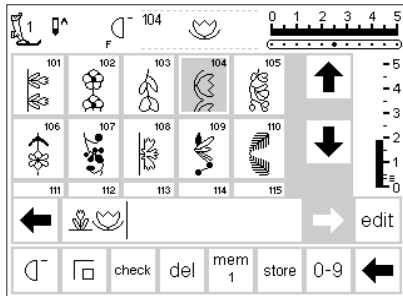

Continue programming

- select the next desired stitch
 - the stitch appears in the mem field
 - continue in this manner
 - start sewing; when the foot control is pressed, the cursor will go to the beginning of the stitch combination for sewing the complete grouping
- Note:** if the contents of the memory have been changed using the edit function (page 40), the Pattern begin function must be selected to start the stitching at the beginning of the combination.

- use Pattern end to stop automatically
- *Toolbar function* – Pattern end will stop after the selected number of combinations have been stitched
- *External button* – Pattern end will stop after stitching the stitch pattern to the left of the cursor
- to save, touch store
- store will blink once to indicate it is saving

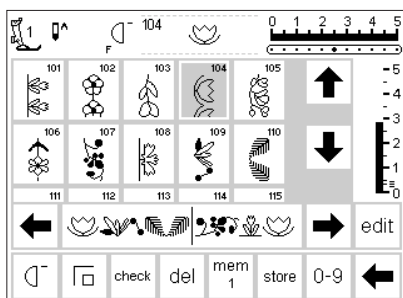

Scroll memory

- scroll arrows are to the right and left of the memory bar
- touch to view the programmed contents either forward or backward
- to close the memory, press the external memory button
- if the stitch combination has not been saved, a message screen will appear asking if you would like to save it

Programming stitches by number

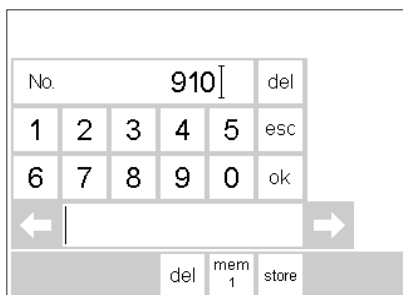

Stitches by number

- open memory
- touch function 0–9
- numbers appear on the screen
- the memory bar remains visible
- touch numbers to select stitch
- the number selected appears above the other numbers

Correct

- touch delete if you make a mistake
- the cursor moves to the left and deletes the number
- select new number

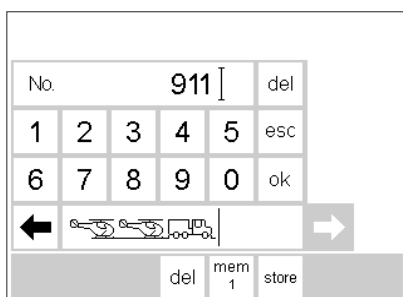

Confirm and continue programming

- touch OK to confirm
- the stitch selected appears in the memory bar
- touch store to save in memory
- select the next stitch by pressing the appropriate number and proceed as above

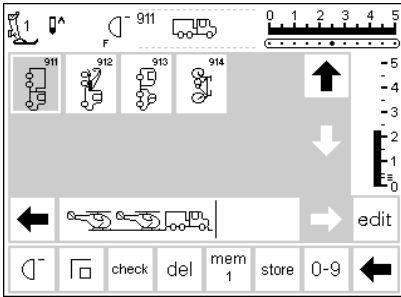

Back to stitch screen

- touch esc
- the screen reverts to the stitch screen which includes the selected stitch
- the selected stitch is activated (highlighted)

Editing memory contents

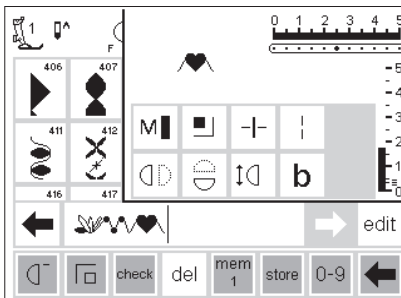

Stitches with functions

- stitches can be modified after being programmed into memory
- program the first two stitches normally
- touch edit
- all available functions appear in the top right section of the screen
- the last stitch in memory (left of cursor) appears above the editing functions

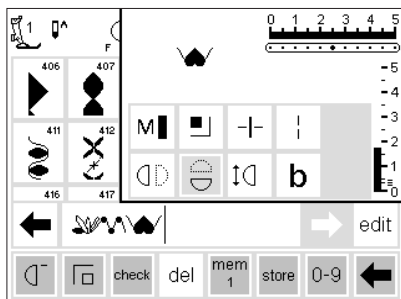

Inserting functions, e.g. mirror image

- place the cursor to the right of the stitch to which mirror image is to be applied
- touch edit
- select mirror image in the functions screen
- the stitch will be shown in mirror image

- the same procedure for insertion applies to all functions
- touch edit to close

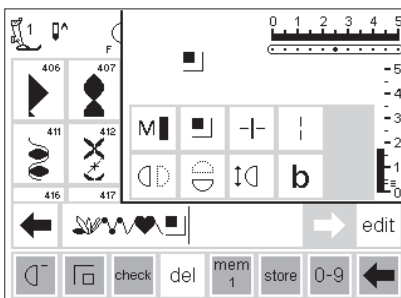

Visible functions (in memory bar)

- the securing function appears as a function in the memory bar
- delete unwanted functions from the memory bar before continuing with programming
- touch edit to close functions

Memory functions

The following functions become available in the center of the screen when the edit function of the memory feature is selected. All functions on the toolbar (except del)

will become inactive when the edit function is selected and will reactivate when the edit function is closed. For more information on these functions, see pages 27.



Motor Speed



Long Stitch

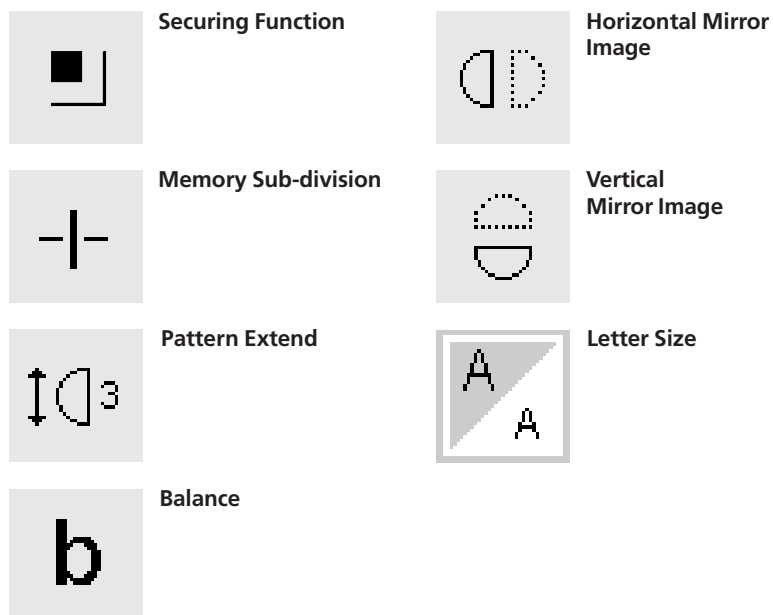

View memory contents

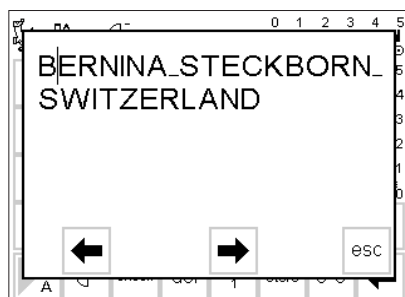

View memory contents

- touch check
- the memory contents appear in a window
- the cursor is visible
- the cursor can be moved into position with the arrows for editing applications
- after viewing, touch esc

- the window closes and the memory bar appears
- the cursor is in exactly the same place as it was in the view window

Corrections in memory

Rule:

All changes and corrections are always made to the left of the cursor.

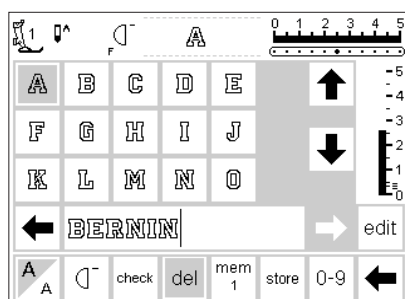

Deleting the last programmed stitch/letter

- touch del
- the last stitch entered (left of cursor) is deleted

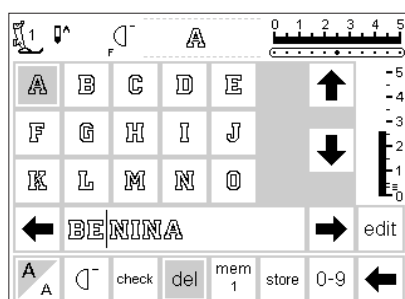

Deleting a stitch/letter within a memory

- place the cursor to the right of the stitch to be deleted
- touch del
- the stitch to the left of the cursor is deleted

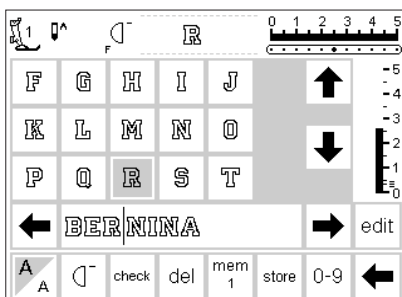

Inserting a stitch in memory

- place cursor where the stitch is to be inserted
- select stitch/letter
- the new stitch is inserted to the left of the cursor

Saving memory contents/leave memory

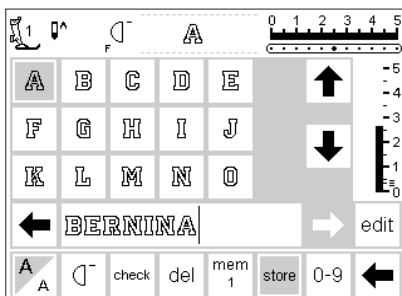

Save and leave memory

- touch store
- the contents are saved
- the memory can be opened and viewed at any time
- touch external mem button

Turning off machine without saving

- memory contents will be lost if the machine is turned off without touching store

Open individual memory

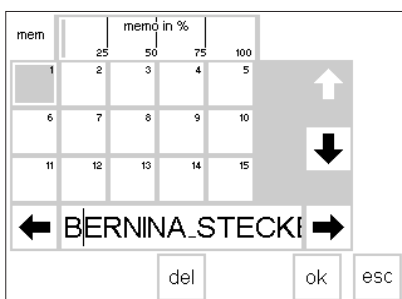

Returning to a previously programmed memory bank

- open memory by pressing the external mem button
- touch mem 1 on the functions toolbar

Note: if the machine has been turned off since the last time the memory feature was used, mem 1 will show on the screen when the memory is activated. If the machine has *not* been turned off, the last memory bank opened will show.

- an overview of the memory banks appear on the screen
- the open memory bank is highlighted (dark gray)
- the occupied memory banks are displayed in light gray

- empty memory banks are shown in white
- memory banks can be scrolled if more than 15 are occupied (can be up to 255 memory banks)
- select an occupied memory bank
- the contents are shown in the memory
- touch esc to return to the previous screen
- the contents of the selected memory remain active
- you can sew, insert, or correct these contents

Note: Contents of memory should be sewn from a stitch screen, not the memory storage screen.

Memory capacity

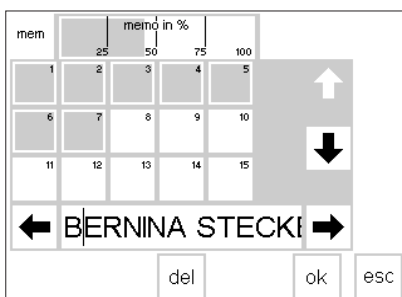

Open mem screen

- open memory by pressing the external mem button
- touch mem on the functions toolbar
- the memory bank screen appears
- the total capacity used by stored stitch patterns is shown in % in the top row
- total capacity of all memory banks together is 1023 stitches

Memory sub-division

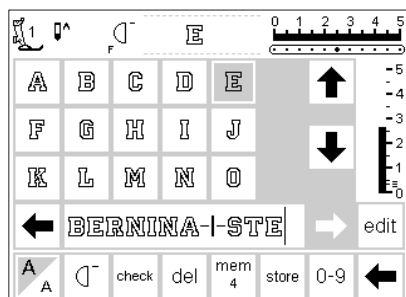

Note: Fabric should be repositioned as needed to stitch each section of the memory.

Memory sub-division

- the contents of a memory can be sub-divided as desired, e.g. name, street, town, etc. by using the edit feature
- program the name
- program the street
- touch edit
- place cursor after the last letter of the name
- select Memory Sub-division
- the sub-divider is inserted to the left of the cursor
- the characters belong to the one memory (e.g. mem 4) but are totally independent of one another so they can be sub-divided as desired

Sewing

- activate Pattern begin and sew
- **Note:** when Pattern begin is activated, the cursor will move to the *right* of the first letter in that memory bank. Stitching will start with the letter to the left of the cursor
- the machine only sews the contents of that particular sub-division
- to sew the next section, place the cursor in anywhere in that section
- begin sewing; when the foot control is pressed, the cursor will go to the beginning of the stitch combination for sewing the complete grouping
- **Note: if the contents of the memory have been changed using the edit function (page 40–41), the Pattern begin function must be selected to start the stitching at the beginning of the combination.**
- if a section is to be sewn only once, touch Pattern End 1 on the function toolbar

Deleting memory

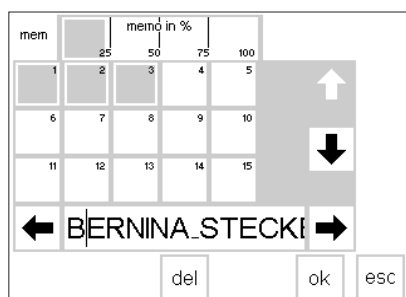

Delete memory

- open memory (press external button)
- touch mem on the functions toolbar
- an overview of the memories appears
- touch memory of choice (e.g. mem 3)
- touch del

- a message will appear asking if you really want to delete the contents of the memory
- touch yes
- the memory contents are deleted
- touch esc to return to the previous screen

Quilt stitches

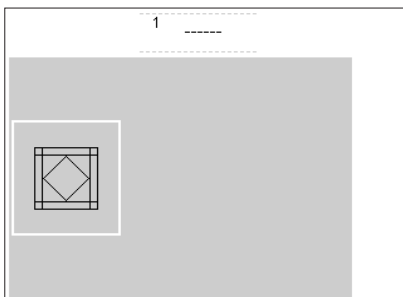

Menu selection: Quilt stitches

- press the external "Quilt Stitches" button
- menu appears
- touch symbol
- quilt stitches appear

Decorative quilt stitches

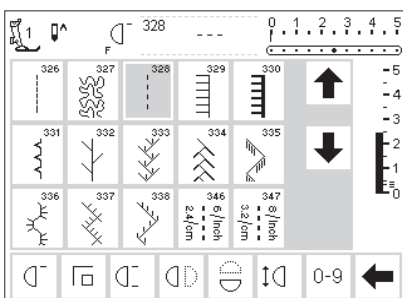

Quilt stitches

- selection of various stitches which are particularly suitable for quilting, piecing, applique, and crazy patchwork:
 - 326 Short Straight Stitch
 - 327 Stippling Stitch
 - 328 Hand-look Quilting Stitch
 - 329 Blanket Stitch
 - 330 Heavy Blanket Stitch
 - 331 Blindstitch
 - 332 Feather Stitch
 - 333–338, 351 Feather Stitch Variations
 - 346–350 Quilting Stitch Variations

- touch to select desired stitch
- the stitch is activated
- all normal information and functions are visible on the screen
- stitch length and width can be adjusted as desired

Balance

All stitches are checked and fully adjusted before the machine leaves the factory.

Different fabrics, threads, stabilizers, and interfacings can affect programmed stitches so that sometimes they might not close or they might overlap, i.e. they are too wide or too narrow.

These effects can be corrected with the electronic balance so that the

stitch formation can be adjusted where necessary to suit the fabric. There are 50 vertical steps.

Open Balance

- touch function b
- if the function is not visible on screen, touch the arrow in the function toolbar to scroll through all the available functions



Balance for practical and decorative stitches

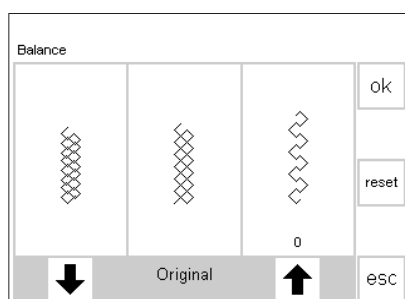

If the stitch looks like this, use this arrow to correct it.

If the stitch looks like this, use this arrow to correct it.

When sewing soft fabrics such as jersey or tricot, the fabric tends to stretch under the presser foot which also stretches the stitch being sewn. For example, the Honeycomb stitch opens up and is too long. Thicker fabrics might cause the stitch to overlap, making it too short. Correcting with balance is very simple.

Balance

- select any stitch
- touch b to activate balance; balance screen appears
- when adjusting practical stitches, a graphic of the honeycomb stitch appears in the center of the screen (*this is used as the example for all practical stitches*)
- when adjusting decorative stitches, a graphic of the satin stitched oval appears in the center of the screen (*this is used as the example for all decorative stitches*)
- two malformations are displayed on either side of the stitch – left too short and right too long
- the arrows at the bottom of the screen show in which direction the stitch must be corrected

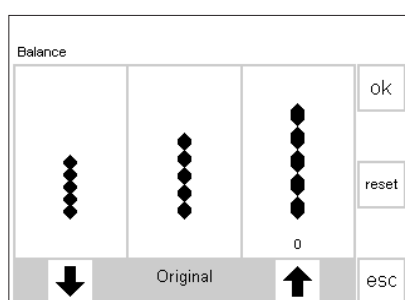

If the stitch looks like this, use this arrow to correct it.

If the stitch looks like this, use this arrow to correct it.

Corrections

Stitch too long:

- touch the arrow shown on the right (approximately 3)
- the number of steps activated will be shown directly above the arrow
- the stitch will be shortened
- the change is *not* shown on screen
- 2–5 steps are normally sufficient to correct the stitch (max. 50 steps)
- sew a test and make additional corrections if needed

Stitch too short:

- proceed as above, using the arrow on the left
- sew a test and make additional corrections if needed

Returning to stitch screen

- after all corrections are made, touch OK to confirm the changes and return to the stitch screen
- touching reset will return the stitch to the same condition as when the balance function was opened
- before selecting a new stitch, press the external clr button to close balance, otherwise it will affect all subsequent stitches

Help

The Help program provides on-screen explanations about individual stitches and all functions, eliminating the need to refer regularly to the instruction manual. The information shown corresponds to information in the instruction manual, but is quicker and easier to find electronically.

No matter which screen is displayed, the help feature for stitches and functions can be opened. Touch esc to return to the previous screen.

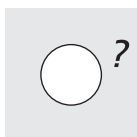

Opening help

- press the external ?-button
- select the desired stitch or function
- a clock on the screen shows that the computer is searching for the desired information



Help screen/Stitches

- the screen offers the following information:
 - name of the stitch
 - suitable fabrics
 - brief listing of main applications

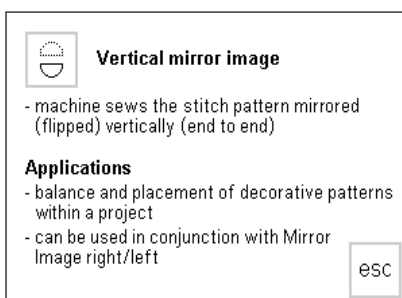

Help screen/Functions

- the screen offers the following information:
 - name of the function
 - explanation
 - brief listing of main applications



Back to previous screen

- touch esc
- Help is closed
- the previous screen appears

Note:

The Help program can be opened at any time without affecting the work at hand.

Tutorial

In computer language, tutorial means self-help. The tutorial provides concentrated on-screen information

about various aspects of the machine.

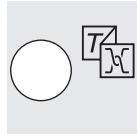

External TC button

- press the external TC button

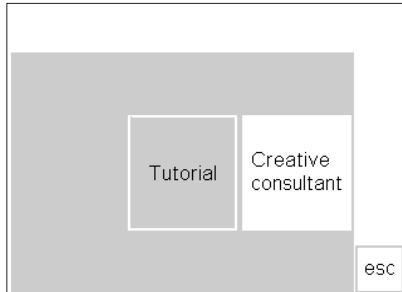

Menu

- the following menu appears:
 - Tutorial
 - Creative Consultant
- touch Tutorial

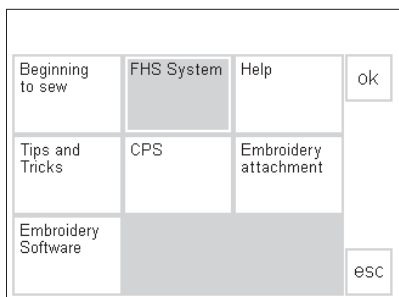

Subjects

- the Tutorial sub-menu appears:
 - Beginning to Sew
 - FHS system
 - Help
 - Tips and Tricks
 - CPS
 - Embroidery module
 - Embroidery Software

- touch to select the desired subject
- touch OK to confirm
- to change subjects, touch esc to return to menu

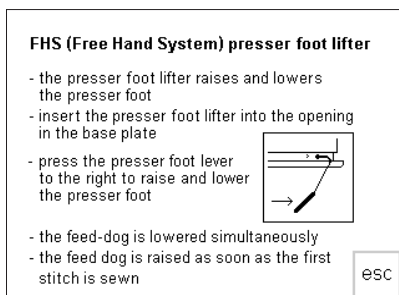

Information

- a clock on the screen shows that the computer is searching for the desired information
- information about the subject of your choice appears on the screen
- touch esc to close the screen and return to the menu

Creative Consultant

The Creative Consultant provides information and help for a variety of sewing needs.

After entering the type of fabric and technique you wish to use, the Creative Consultant provides suggestions regarding needles, presser feet, interfacings, special

settings, etc. The suggested presser feet are not necessarily standard with the machine but may be special accessories which can be obtained from your **BERNINA** dealer.

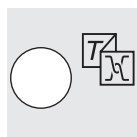

External TC button

- press the external TC button

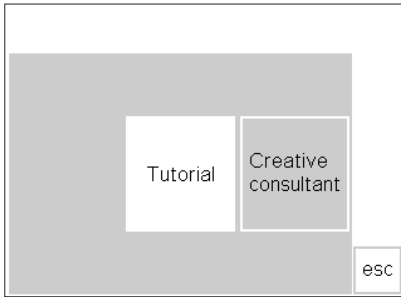

Menu

- the following menu appears:
 - Tutorial
 - Creative Consultant
- touch Creative Consultant

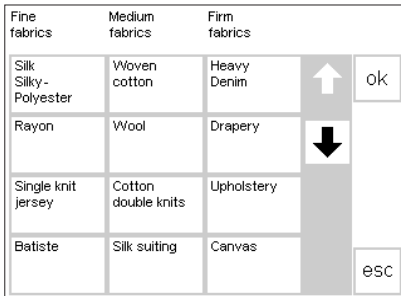

Fabric menu

- 3 columns of fabric types are displayed
 - light-weight fabrics
 - medium-weight fabrics
 - heavy-weight fabrics
- the most commonly used fabrics are listed in the three columns

- if the fabric you wish to use is not listed, select a similar type of fabric
- use the arrows to scroll up and down for all choices
- touch to select the desired fabric
- touch OK

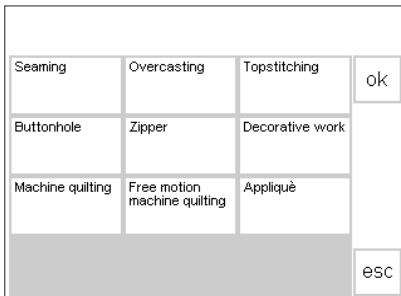

Techniques menu

- several common sewing techniques appear on-screen:
 - Seaming
 - Overcasting
 - Topstitching
 - Buttonhole
 - Zipper
 - Decorative work (decorative stitches)
 - Machine quilting
 - Freemotion machine quilting
 - Appliqué

- touch to select the desired technique
- if the technique you want to use is not listed, select a similar technique
- touch OK to confirm and move to the information screen

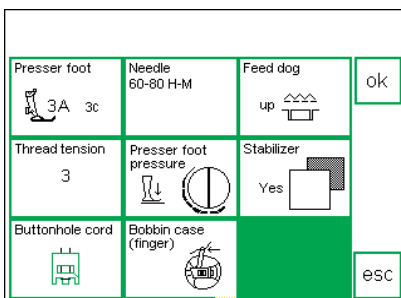

Information, special suggestions, thread tension

- the screen displays settings and suggestions for the type of fabric and technique you have chosen:
 - Presser foot number(s)
 - Needle size and type
 - Feed dog position
 - Thread tension
 - Presser foot pressure
 - Stabilizer needed
 - Special suggestion
- there may be several suggestions for the presser foot and needle type
- some presser feet suggested may be special accessories which are particularly suitable for the chosen technique (they may not be standard accessories, but can be purchased separately)

- select the presser foot and needle according to your particular wishes and preferences
- a stabilizer will be suggested if it is required to suit the technique and fabric
- provides a reminder to use buttonhole cord (gimp) if necessary to reinforce a buttonhole



Back to selected stitch

- touch OK to confirm
- the machine will automatically go to the appropriate practical stitch screen with the correct stitch automatically selected

- if decorative work was selected, the machine will go to the first screen of decorative stitches with stitch 101 selected
- sewing can begin immediately
- the suggested stitch can be changed at any time

Smart Function

Sometimes you have to interrupt a task at hand to complete another piece of sewing which must be done before you can carry on any further.

The Smart function was designed specifically for the purpose of “remembering” the machine’s current settings so that you can return to them later.

The screen in which you are working with all the settings you made can be saved and easily re-opened.

Saved settings in the Smart Function are lost when the machine is turned off.

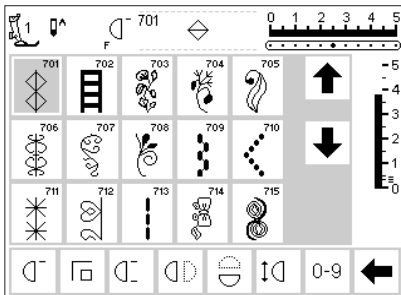

Application

- you have created and stored something in memory
- you have tested or completed some of the work
- you plan to finish at a later time

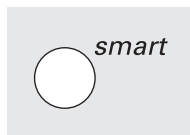

Saving the screen with the Smart Function

- press the external Smart button
- the screen, complete with all the settings (stitch, functions, memory etc.) is saved

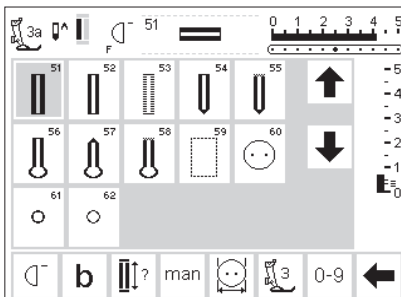

Second Task

- switch to any appropriate stitch menu for another task
- complete this task

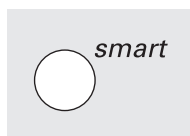

Smart Function – back to screen

- press the external Smart button
- the original screen appears
- all settings are exactly as you left them and you can carry on with your original task

Setup Program

The Setup program allows you to personalize the screen to suit your own requirements and preferences.

You can change basic settings permanently and program the F (Favorite function) button on the head frame (above the needle). There are numerous possibilities – check the headings and decide what you want to do.

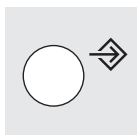





Setup

- press the external Setup button
- the menu appears
- you can alter any of the features listed

All changes made in the Setup program will be saved, even when the machine is turned off.

The machine can be reset and returned to the factory settings at any time.

- the original settings can be reset at any time

Personal Program 	Functions 	Stitch length Stitch width Needle position
Beeper 	Motor speed	
Start screen	Return to basic setting	Sewing light
Service		
	esc	

Menu

- the menu lists all those features which you can alter to suit your requirements:
 - Personal Program
 - Functions
 - Stitch length/width/needle position
 - Beeper
 - Motor speed
 - Start screen

- Return to basic settings
- Sewing light
- Service
- Screen Contrast
- personal settings remain saved even when the machine is turned off
- the machine can be reset to its original settings or reprogrammed with desired settings at any time

Functions in Setup

The functions at the right are found in the set-up program of the **artista** sewing machine. They are accessed by pressing the external set-up button on the front of the machine

and then touching Functions on the screen. These functions are used when personalizing the screen to your requirements and preferences.

Pers.
Pro.

Personal program

- touch Personal program
- your Personal program is activated
- this function can be programmed in the Setup program

Application:

- move this function to the toolbar for a fast way to access your Personal program



Changing the screen

- touch arrow
- removes functions from the Setup program



Insert functions in Setup

- touch arrow
- inserts functions into the Setup program

reset

Back to basic settings

- touch reset
- all changes in the Setup program are returned to basic settings

Personal Program

Use the Personal program to design a screen with the stitches you use most often. Whether it is made up of stitches for a certain type of sewing, such as heirloom or garment, or just your favorite decorative stitches, this screen will make it easy and quick to sew any project.

When inserting stitches into the Personal program, variations (different stitch widths, stitch lengths, and needle positions) of all stitches may be entered into the Personal program.

Alphabets cannot be stored in the Personal program.

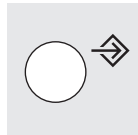

Setup

- press the external Setup button
- menu appears

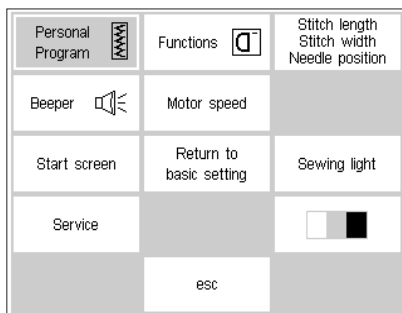

- touch Personal Program
- Personal Program screen appears

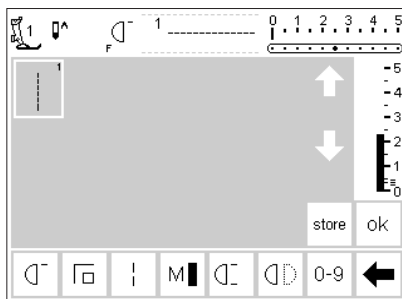

Personal program (programming first stitch)

- straight stitch always appears as the first stitch
- personal selections can now be entered in the "empty" screen

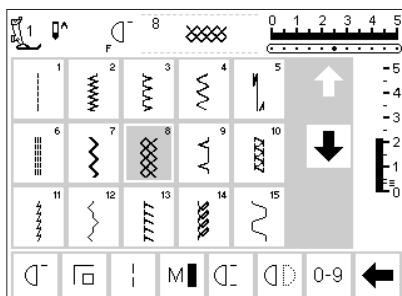

Inserting stitches

- press the Practical stitches external button
- select Honeycomb stitch (stitch 8)

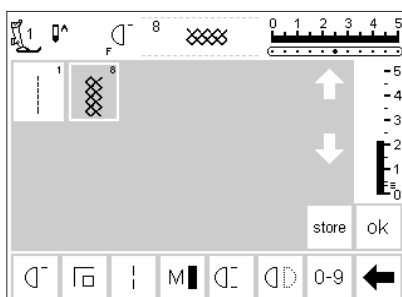

Personal screen

- the screen changes to the Personal Program
- Honeycomb stitch appears
- touch store to save the stitch in your personal program
- when a new stitch is programmed, it will be inserted automatically after the last stitch

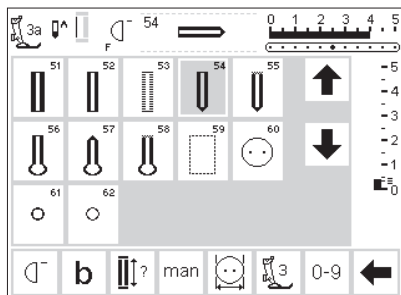

Inserting the second stitch

- press the external Buttonhole button
- touch the round buttonhole (stitch 54)

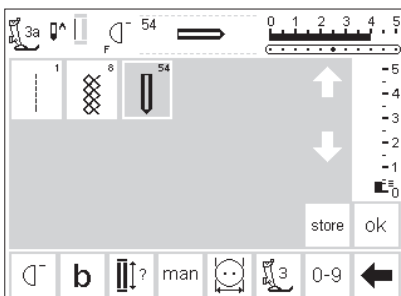

Personal screen

- screen changes to personal program
- the round buttonhole appears on the screen
- touch store to save the buttonhole in your personal program
- continue programming in this manner until all desired stitches are selected

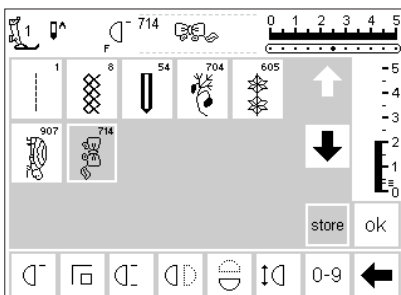

Personal program (additional stitches)

- the top row of five spaces is occupied
- the 6th stitch appears in the next row
- you can program upto 60 stitches in the personal program
- if more than 15 are programmed, the arrows can be used to scroll the screen in the standard program



Save and close

- touch OK
- screen closes and Setup menu appears
- touch esc to close
- returns to the last stitch screen opened with the last selection still highlighted



Personal program function

- to open your personal program, the Personal Program function must be inserted in the function toolbar (see pages 53–55)



Favorite function

- for even easier access, your personal program can be programmed into the Favorite function button located on the frame of the machine above the needle (see page 54)

Deleting stitches from the Personal Program

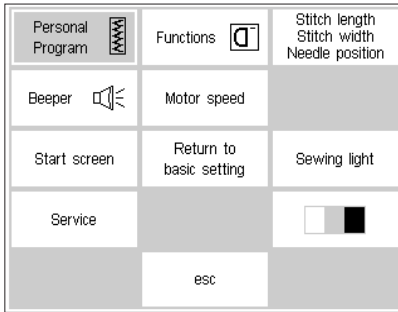

Setup menu

- press the external Setup button, menu appears
- select personal program

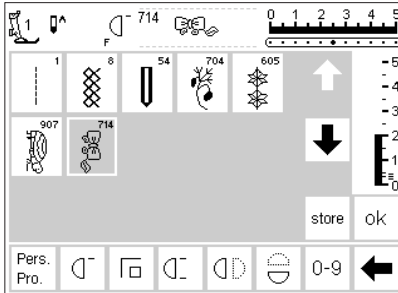

Personal screen

- personal screen appears
- select stitch to be deleted (will be highlighted)

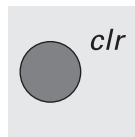

Delete the stitch

- press the external clr button

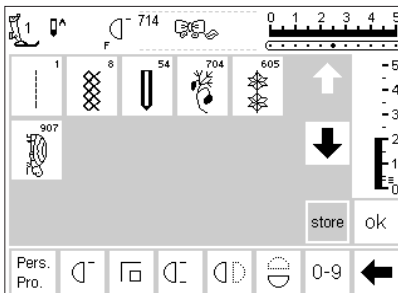

Stitch deleted

- the stitch is deleted
- all remaining stitches move back one space
- touch store to save the changes



Close

- touch OK
- the screen closes
- Setup menu appears

Programming functions

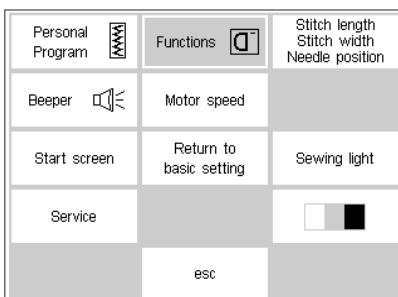

Setup menu

- press the external Setup button, menu appears
- menu appears
- touch Functions

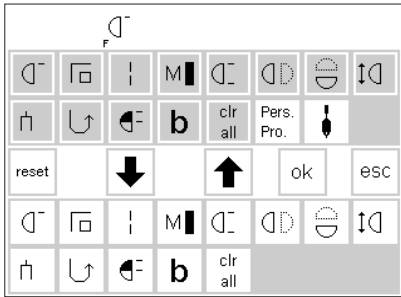

Functions screen

- all functions available appear on the screen
- the bottom two rows of functions are the same as those that are active in the practical stitch screen (includes functions that may be hidden on the stitch screen)

- these functions can be used in any screen
- all functions in the lower rows are active
- the upper two rows of functions correspond to the lower functions
- the arrows in the center row are used to move functions

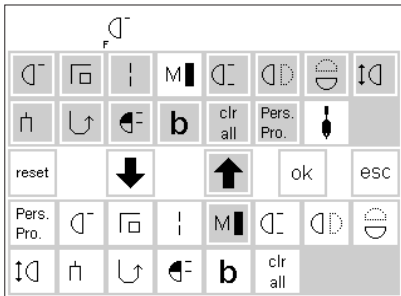

Removing functions

- select Motor Speed in the lower two rows
- touch the up arrow
- the function disappears from the lower rows
- the function has now been transferred to the upper rows and will no longer appear on individual screens, such as the practical stitch screen

- the function is highlighted in the upper rows and has been deactivated (removed) from the lower ones
- move and deactivate other functions in the same way

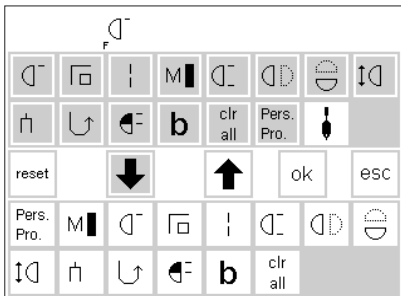

Insert function

- a removed function can be reinstated at any time
- select Motor Speed in the upper rows
- touch the down arrow
- the function is moved to the first position in the function toolbar in the lower rows
- all other functions move one space to the right

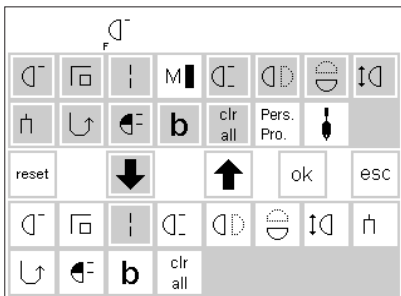

Insert new function between two existing functions

- a new function can be inserted between two existing functions
- select a function from the upper rows
- touch the position in the bottom rows where you want to insert the function

- touch the down arrow
- the function will be transferred to the selected position
- the replaced function (the one you selected) and all others will move one space to the right

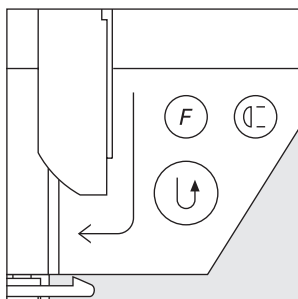

Program F (Favorite Function) button

- select any function (including the Personal Program) from the top two rows
- press the external F button (above the needle)
- press the down arrow
- the F button is now programmed

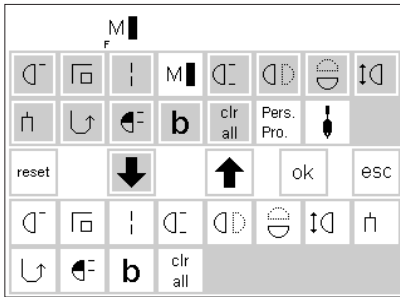

- the programmed function is displayed on the screen to the right of the needle stop position symbol
- it can be reprogrammed in the same manner as often as you like

reset

Return all functions to basic settings

- touch reset
- all functions will be returned to their original positions *except* the Favorite function button on the head frame

- to reprogram the Favorite function button, follow the same steps
- the new function will replace the old

ok

Save changes and close

- touch OK
- changes are saved
- screen closes
- Setup screen appears

Changing basic settings for stitch width, stitch length and needle positions

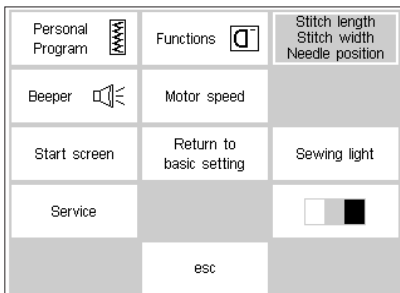

Open Setup

- select stitch for which you want to alter the width, length, and/or needle position
- press the external Setup button
- menu appears
- select stitch length, stitch width, needle position

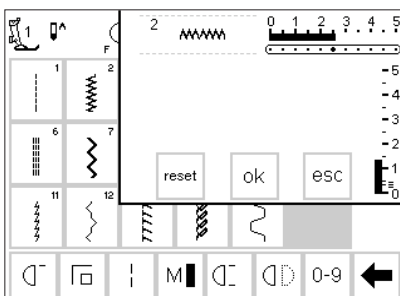

Changing the settings

- the stitch width, length and needle position screen appears
- alter the stitch width and length settings using the external controls
- alter the needle position with the external buttons
- touch OK to save

- to return to basic settings, touch reset
- touch esc to close Setup and return to the last selected stitch screen

Beeper

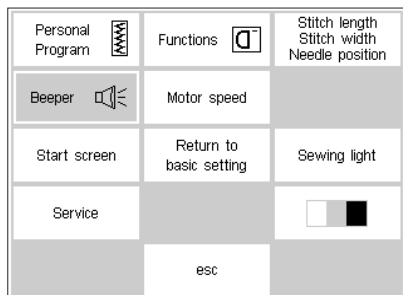

Setup menu

- press the external Setup button, menu appears
- touch Beeper
- beeper menu appears

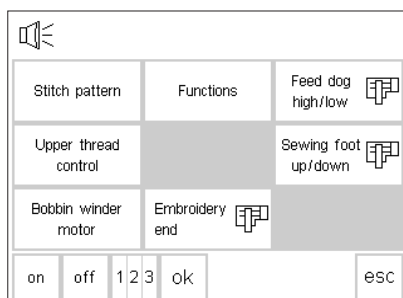

Audio signals

- audio signals can be applied to the following:
 - stitches
 - functions
 - feed-dog raised/lowered (for embroidery)
 - upper thread control
 - position of presser foot (for embroidery)
- bobbin winder
- embroidery end
- audio signals can be turned on and off
- the number of repeats can be selected
- the number of beeps can be set at 1, 2, or 3

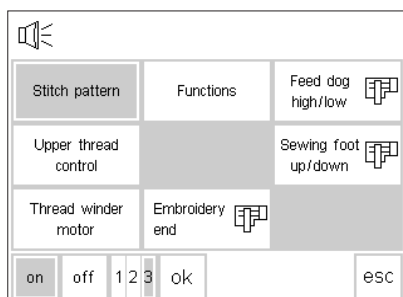

Adding a signal

- select desired item from the menu
- touch on
- touch the number pad until the number of beeps you want (1, 2, or 3) is highlighted

Deleting a signal

- select desired item from the menu
- touch off
- the audio signal is turned off for this feature



Save and close

- touch OK
- changes are saved
- screen closes
- Setup screen appears

Changing the motor speed

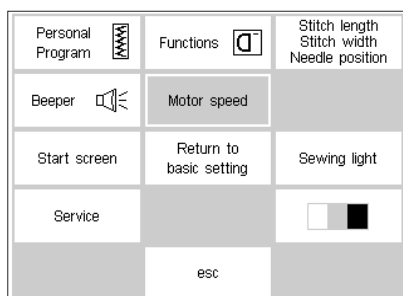

Setup menu

- press the external Setup button, menu appears
- touch Motor Speed
- menu appears

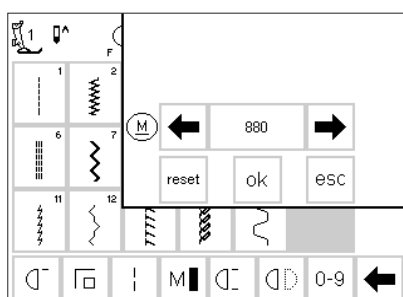

Change the maximum motor speed

- touch the arrows to alter the maximum sewing speed (880 stitches/minute is the basic setting)
- a reduction or increase in the motor speed is reflected in this number
- each touch of an arrow increases or decreases the number of stitches per minute by 10
- any change of the maximum speed affects all 4 speeds ($\frac{1}{4}$, $\frac{1}{2}$, $\frac{3}{4}$, $\frac{4}{4}$) = slower or faster at all four levels

ok

Save and close

- touch OK to confirm the change
- touch esc to return to the Setup menu
- touch esc to return to the last selected stitch menu

Back to basic settings

- follow the directions above to enter the motor speed menu
- touch reset to revert to factory settings

Start screen on and off

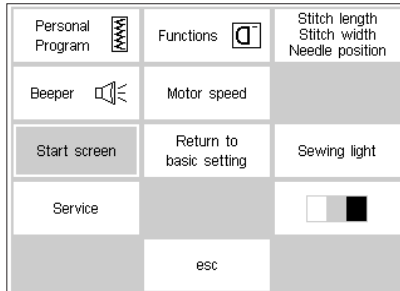
**Setup menu**

- press the external Setup button
- menu appears
- touch Start Screen

**Turn start screen off**

- start screen appears
- the start screen can be turned on or off
- touch off
- the start screen will *not* appear next time the machine is turned on
- the practical stitch menu will appear immediately when the machine is turned on

Turn start screen on

- touch on
- the start screen will appear every time the machine is turned on, followed automatically by the practical stitch menu

ok

Save and close

- touch OK to confirm the change
- touch esc to return to the Setup menu
- touch esc to return to the last selected stitch menu

Return to basic settings

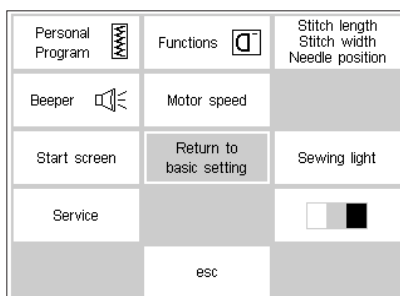
**Setup menu**

- press the external Setup button, menu appears
- touch Return to Basic Settings

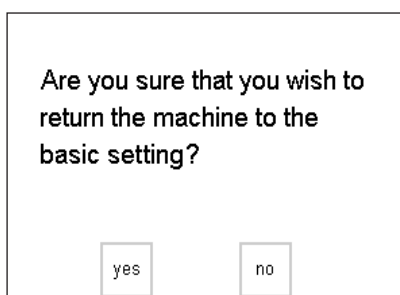

- a message will appear asking you to confirm that you want to return the machine to the basic settings
- touch yes; the Setup screen reappears
- a clock shows on the screen indicating that all changes in Setup are being reversed

- touch no; the Setup screen reappears
- all existing changes to Setup remain in effect

Please switch off and on your machine.

- a message will appear switch off and on your machine
- the factory settings are restored

Sewing light

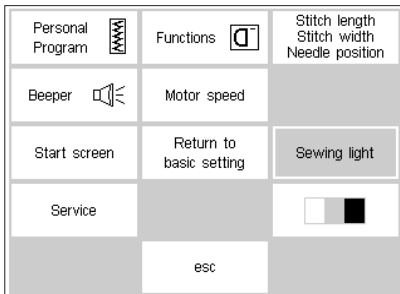

Setup menu

- press the external Setup button, menu appears
- select Sewing Light

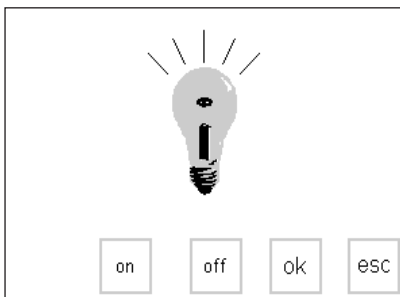

Switch light on/off

- touch on
- light will be on continuously when machine is turned on
- touch off
- light will not come on at all



Save and close

- touch OK to confirm the change
- touch esc to return to the Setup menu
- touch esc to return to the last selected stitch menu

Service

The service function of the Setup program gives information about the version of software in the **artista** and lets you make calibration adjust-

ments to the screen and hoop of the embroidery module (special accessory).

Version Information

The version screen shows information about the version of software loaded into the sewing machine and embroidery module (special accessory). This

information is helpful if you are asking questions of the dealer or if you plan to upgrade the software.

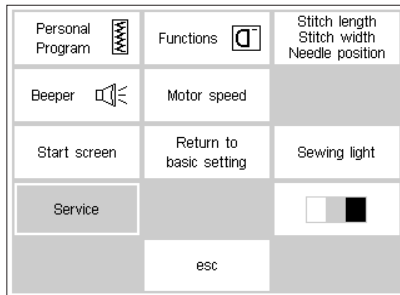

Setup menu

- press the external Setup button, menu appears
- touch service

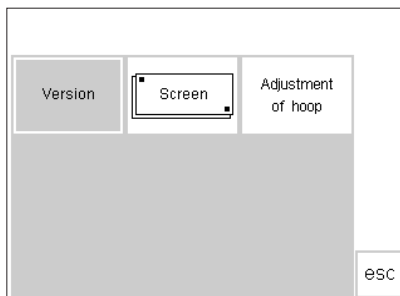

Service Screen

- service screen appears
- select version

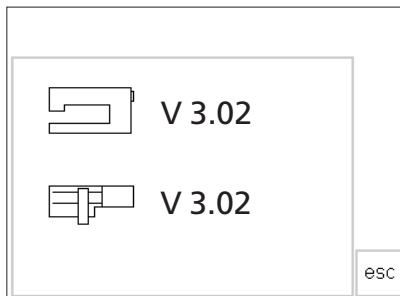

Version information

- version screen appears
- shows the version of software loaded into the **artista** sewing machine
- shows the version of software loaded into the embroidery module (special accessory), if applicable
- the embroidery module must be connected to the machine to show the version on the screen

- the version of software in the sewing machine and in the embroidery module must be the same for optimum results
- touch esc to return to the previous screen

Screen Calibration

Calibrating the screen is important for making on-screen selections by touch. If the screen is not calibrated, you may touch one selection and the machine will read one next to it. For precision touch selection, the screen may be calibrated.

Note: The screen is calibrated at the factory, but shipping and transporting may affect it. The screen only needs to be calibrated if there is a problem with precision touching.

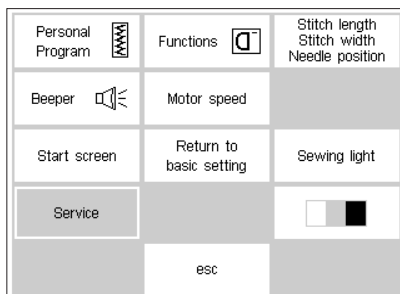

Setup menu

- press the external Setup button, menu appears
- touch Service

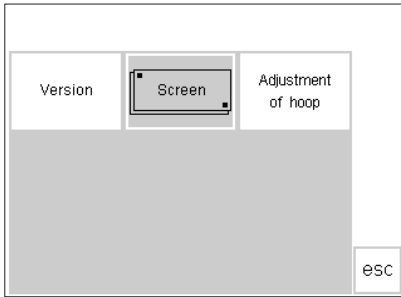

Service Screen

- service screen appears
- select screen
- select this screen if the on-screen buttons do not react properly when selected (touched)

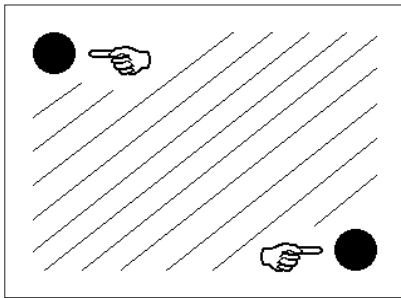

Calibration

- screen calibration screen appears
- press each black point in the center, one after the other
- it is not important which point is selected first
- the machine will beep when the dots are touched to let you know contact was made
- will automatically go back to the previous screen
- touch esc to return to the setup screen

- touch esc to return to last selected stitch screen

Important Note: When calibrating the screen, take care to touch the *black dots only*. If the screen is miscalibrated by touching any area other than the black dots, it may require a technical adjustment by an authorized technician.

Embroidery hoop adjustment

This adjustment calibrates the needle to the center of the embroidery hoop and is only needed the first time the embroidery module

(special accessory) is being used. The hoop adjustment can only be activated if the Embroidery Module is attached

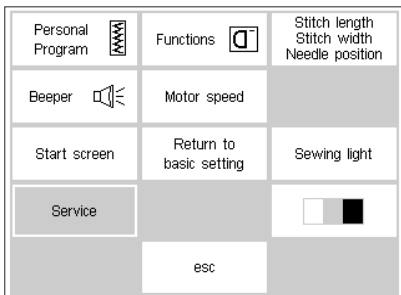

Setup menu

- press the external Setup button
- menu appears
- touch service

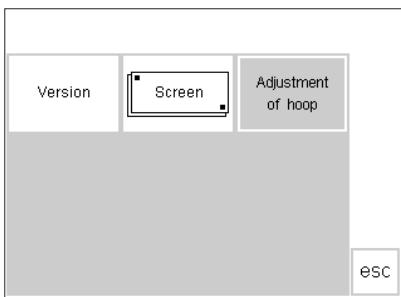

Service Screen

- service screen appears
- select Adjustment of hoop

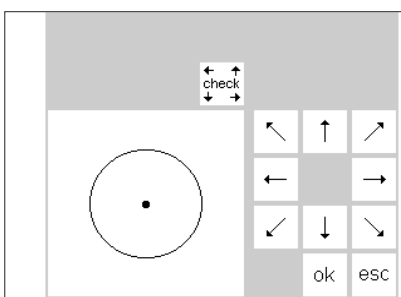

Hoop adjustment

- hoop adjustment screen appears
- connect the embroidery module to the machine
- attach the large hoop to the embroidery module
- insert the embroidery template into the hoop

- touch check – the machine reads the hoop position; the needle should be positioned exactly over the center point of the template
- if it is not, adjust with the arrows
- it is only necessary to adjust the hoop once – the same setting changes will apply to all the hoops

ok

Save and close

- Touch OK – close the screen
- Touch esc – close Setup
- Touch check in Layout 1 – close embroidery hoop adjustment

Screen contrast

The contrast of the screen can be adjusted for easier viewing.

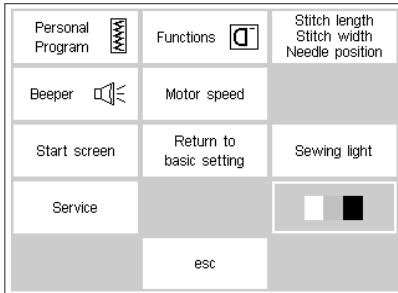
**Setup menu**

- press the external Setup button, menu appears
- touch contrast (lower right of screen)
- contrast screen appears

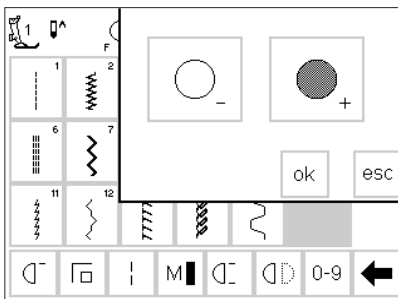
**Adjust contrast**

- two adjustments are provided to adjust the contrast (- = lighter, + = darker)
- touch to increase or reduce the contrast
- the original screen is visible on the left to control and check the adjustments as they are being made

ok

Save and close

- touch OK
- changes are saved
- screen closes
- Setup menu appears

Leave Setup program

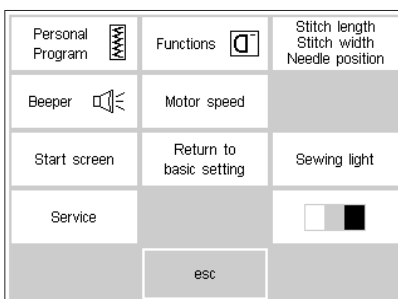
**Leave Setup menu**

- touch esc
- Setup is closed
- changes are saved
- changes remain saved when the machine is turned off

eco (ecology) function

The green eco (ecology) function button on the front of the machine saves energy when the machine is not in use, but you don't want to turn it off and lose the settings. It can be compared to the sleep feature on a computer.

If the eco function is activated, the machine uses about 50% less energy. The screen in which you are currently working, all memory contents, and any other functions which you have selected remain active. The screen

goes dark and details are just visible. Once you begin working again, the machine will be returned to its normal state.

Besides saving energy, the eco function is also a child safety device. Once the eco function is activated, the machine is "locked" and the foot control is inactive. The machine will only sew after turning off the eco function (pressing the button once), returning it to the last active screen.

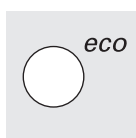

Eco function

- touch the external eco button
- energy used will be reduced by 50%
- useful when interrupting work for longer periods

Screen

- screen goes dark, details are just visible
- the machine will *not* sew in eco mode, it is "locked"
- all settings remain
- foot control will not operate the machine

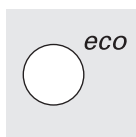
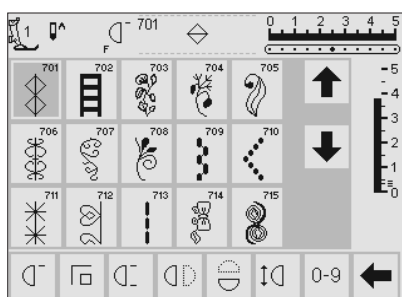

Return to sewing

- touch the eco button
- machine returns to normal function
- the eco function is cleared when the machine is turned off

Optional accessories

The following pages offer information about additional accessories and attachments available for the **artista** sewing machine. These accessories will add to the capabilities and versatility of the machine,

offering unlimited possibilities for expressing your creativity.

Ask your Bernina dealer for more details!

CPS Program (optional accessory)

CPS Program (Customized Pattern Selection)

This program allows you to replace a variety of stitches on your sewing computer AND replace designs and alphabets within the embroidery module (optional accessory).

Ask your **BERNINA** dealer for further details!

The CPS program allows you to personalize your sewing machine to suit your preferences and sewing requirements. And you can do it as often as you want.

Embroidery module (optional accessory)

Embroidery module (optional accessory)

The embroidery module is a wonderful addition to your sewing machine, offering you unlimited possibilities to use your imagination and creativity to their full extent. It provides the possibility of sewing a wonderful array of large motifs in full color. The module attaches to the free arm and is connected to the right side of the machine in the connecting socket provided; it comes preprogrammed with 18 assorted motifs. When

selected, they appear on the screen and can be sewn immediately. You can position, mirror image, enlarge and reduce the motifs.

Additional embroidery motifs, covering a wide range of subjects are available on cards. Just insert a card into the embroidery module, select, and sew!

A detailed instruction manual is supplied with the embroidery module.

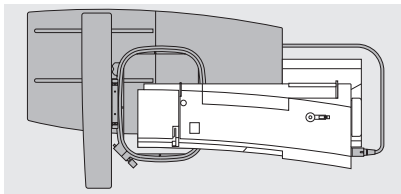

Connecting the embroidery module

- turn the sewing machine *off*
- remove the accessory box or sewing table
- position the module on the back of the free arm
- push the engaging lugs into the base plate of the machine (back right)

- insert the plug in the connection on the right side of the machine (embroidery module symbol)
- turn sewing machine *on*

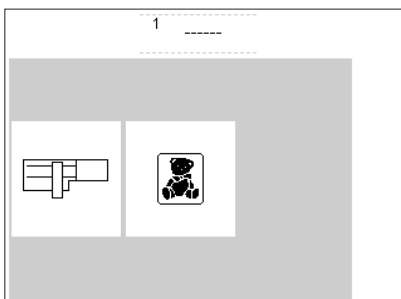

Designs

- embroidery menu appears
- touch the embroidery module symbol to access the preprogrammed designs
- touch the teddy bear symbol to access designs from cards (extra accessories – see page 64)

- the position, size, and density of the motifs can be altered
- designs can mirror imaged, as well as rotated
- a detailed instruction manual is supplied with the embroidery module.

Embroidery cards (optional accessory)

Preprogrammed embroidery design cards covering a wide range of subjects can be used in conjunction with the embroidery module.

Each card is devoted to one particular theme. New cards are introduced on a regular basis so that you can build

up a diverse library of beautiful motifs, each relating to a specific subject or theme.

The cards are inserted into the embroidery module. You can then view the motifs on the screen of your sewing machine.

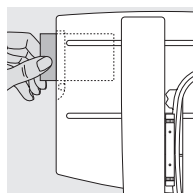

Inserting the card

- turn the sewing machine off
- insert the card into the slot in the module

Embroidery card menu

- the embroidery menu appears
- touch the teddy bear symbol

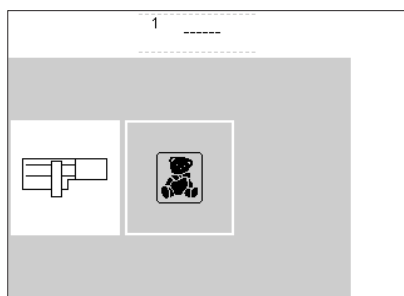

Embroidery motifs on the card

- the first motif screen appears
- each motif is numbered
- scroll to view further motifs
- select and sew the same as for stitches programmed on the embroidery module

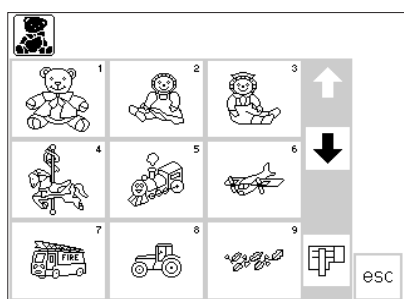

artista Embroidery Software (optional accessory)

BERNINA Software comes in a variety of levels enabling you to choose the software right for you. All are Windows based, easy to learn and fun to use.

Artlink comes with 24 designs, including many licensed designs. This Software has the ability to rotate, re-scale, mirror image and preview designs before they are sewn.

Editor provides a powerful base for the designer software. It comes with 211 designs and 42 alphabets giving you the creative freedom to edit existing designs and personalize them. Add **Auto-Designer** for automatic digitizing capabilities with a single click beginning with your own artwork. Move to the **Designer** level to have manual digitizing tools, plus the ability to use your Windows True Type

fonts in your embroideries. Add **Cross-Stitch** at any level to do cross stitch embroidery by machine. Add **PhotoSnap** to be able to stitch a picture at the Auto-Designer level and on. Choose one software package for your embroidery needs or have it all with **DesignerPlus**.

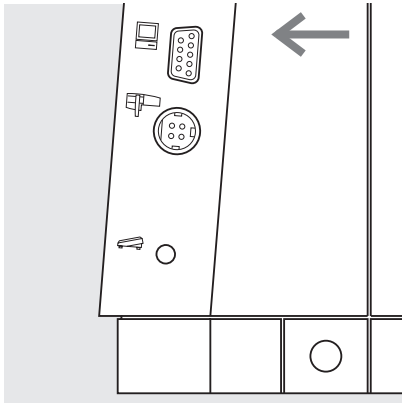

Connection cable

- turn the machine *off* before attaching the cable
- insert the cable into the appropriate socket on the right side of the machine (PC symbol)
- turn the machine on

Detailed instruction manuals are supplied with the **artista** software programs.

Important facts about sewing machine needles

Sewing machine, needle and thread

Your Bernina uses needle system 130/705H.

Needle and thread

The most commonly sold needles are nos. 70–120. The finer the needle, the lower the number. The table shows you which needle is suitable for which threads. The needle size select must correspond to the thread size.

Needle/ thread table	70	80	90	100	110–120
Darning thread	○	○			
Embroidery thread		○	○		
Mercerized cotton thread		○	○		
Synthetic thread		○	○		
Thick threads, synthetic merc. thread			○	○	
Buttonhole thread for decorative seams (cordonnet)				○	○

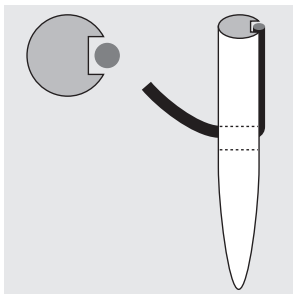

Correct needle/thread combination

When sewing, the thread runs in the long groove on the needle.

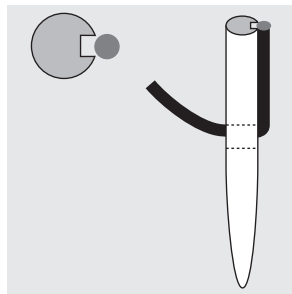

Unsatisfactory needle/thread combination

If the needle is too fine the groove on the front cannot accommodate the thread and faulty stitching occurs.

Needle and fabric / Condition of needle

The needle must be in perfect condition. Problems can occur with damaged needles.

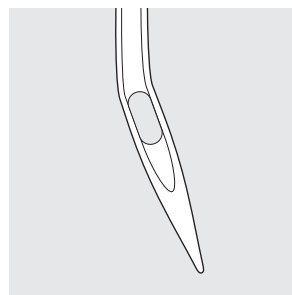

bent needle

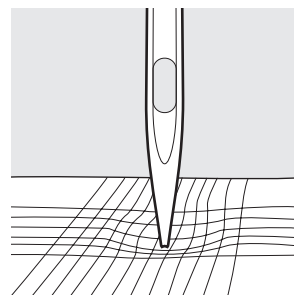



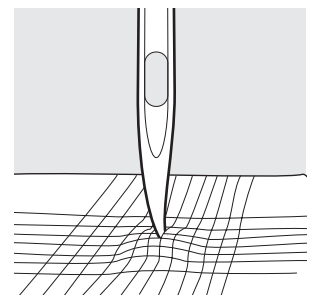





blunt needle



burred needle

Important facts about sewing machine needles

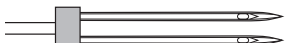
Special materials are easier to sew if the appropriate needle is used. Special needles are available at your **BERNINA** dealer.

Needle table	Description	Needle point	Suitable for	
Standard needle	130/705H	Normal point, slightly rounded	Universal needle for woven, synthetic and natural fibers, e.g. linen, chiffon, batiste, organdy, wool, satin, decorative stitching, embroidery	
Special needles	130/70H-SES	Fine ball point	Fine knits, especially for synthetic fibers	
	130/705H-SUK	Medium ball point	Heavier knits in synthetic or natural fibers	
	130/705H-S	Medium ball point, stretch	Special needle for delicate or difficult stretch fabrics	
Jeans needles	130/705H-J	Very fine point	Overalls, heavy linen, denim, canvas. Pierces dense fabrics easily	
Leather needle	130/705 H-LR+H-LL	Cutting point	Natural and synthetic leather, plastic, coated and waxed fabric	
Double needle	130/705 H/TWI	Needle distance 1.6, 2.0, 2.5, 3.0, 4.0	Visible hems in stretch fabrics, pintucks, decorative sewing	
Triple needle	130/705 H/TRI	Needle distance 2.5, 3.0	Decorative sewing	
Hemstitch needle	130/705H/HE	wide needle	Hemstitching in fine fabrics	

Feed-dog and fabric feed

Feed-dog and stitch length

With each stitch the feed-dog moves forward by one step.

The length of this step is determined by the stitch length selected. With an extremely short stitch length, the steps are also short. The fabric moves under the foot quite slowly, even at full sewing speed. Buttonholes, satin stitch and decorative stitches are all sewn with a very short stitch length.

Important

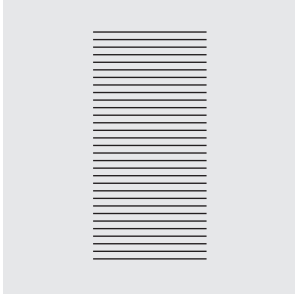

Let the fabric feed evenly!

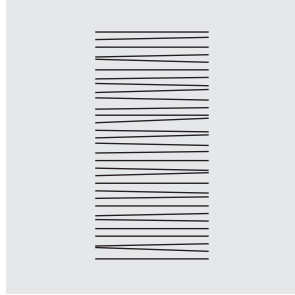

Pulling or pushing will result in gaps.

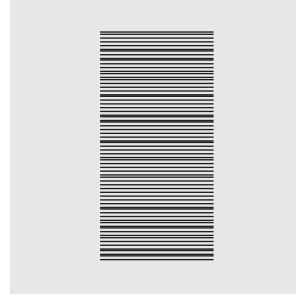

Holding back will result in knots.

Height compensation tool

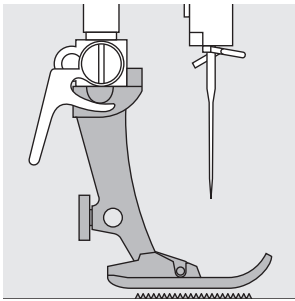

The feed-dog can work normally when the foot is level.

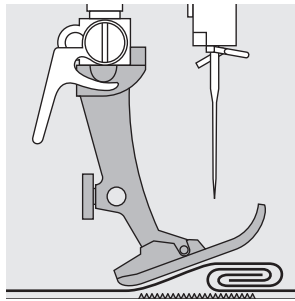

If the foot is at an angle, e.g. when sewing over thick to thin or vice-versa, the feed-dog can not grip and feed the fabric and the work sticks.

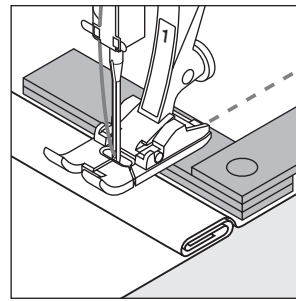

To solve this problem, place one, two or three compensating plates as required behind the needle under the presser foot.

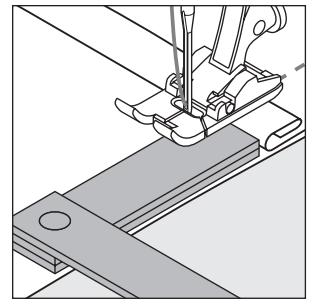

To correct the height in front of the foot, place one or more plates to the right of the foot next to the needle. Sew until the foot is level again and remove the plates.

Feed-dog and sewing corners

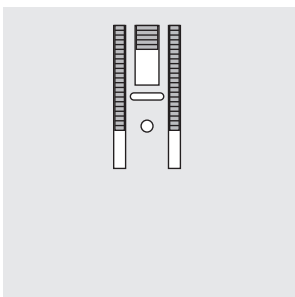

The gap between the two rows of teeth is relatively large due to the width of the stitch plate hole.

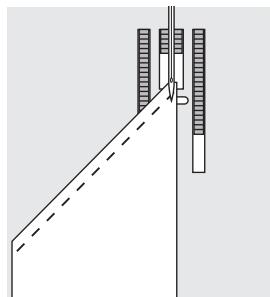

When sewing corners only a small section of the fabric is actually on the feed-dog so that it cannot grip the fabric well.

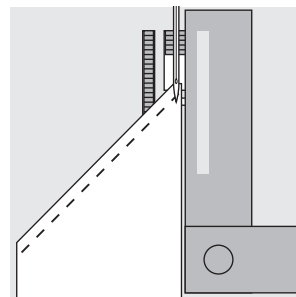

Correct this by placing one or more compensating plates as close as possible to the edge of the fabric.

Cleaning

If the machine is stored in a cold room, it should be brought to a warm room about 1 hour before use.

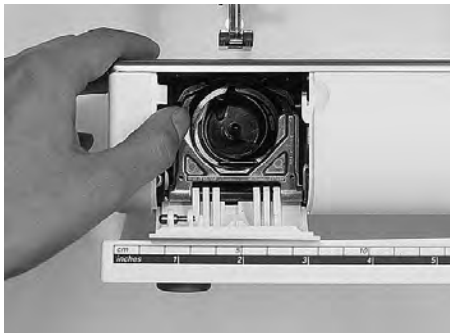
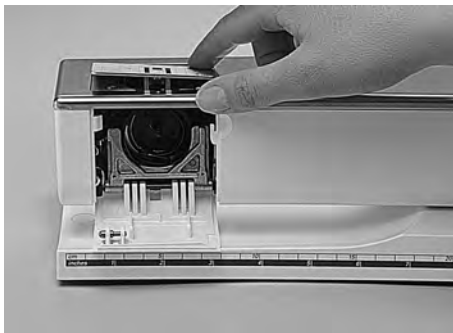

Cleaning

Periodically remove thread fluff and remnants which collect under the stitch plate.

- turn power switch to 0
- remove presser foot and needle
- open the free-arm cover
- press the stitch plate down back right
- lift and remove it
- clean the area with the brush
- replace the stitch plate

Cleaning the hook

- power switch to 0
- remove the bobbin case
- press the lower release lever to the left
- fold down the semi-spherical locking strap with black hook race cover
- remove the hook
- clean the hook using the brush provided or a cotton swab. The use of any sharp instrument could damage the hook.
- insert the hook, turning the handwheel if necessary until the hook driver is on the left
- close the black hook race cover and locking strap, the pawl must engage
- check by turning the handwheel
- insert the bobbin case

Lubricating

For machines with the metal CB-hook system, lightly oil (1-2 drops) the hook race. After replacing the bobbin case and bobbin, sew off the machine on scrap fabric to prevent oil from getting on your work. Machine should be oiled each time it is cleaned.

Important!
Never use oil, alcohol or solvents of any kind on any part of the machine!

Cleaning the screen

- wipe with a damp cloth

Cleaning the machine

- wipe with a damp cloth
- if really soiled, wipe with a solution of water and a few drops of soap liquid

Replacing the Sewing Light



Contrary to an ordinary bulb, the CFL sewing light has a better illumination and a longer life.

Caution:

Please note that a defective CFL sewing light must **ONLY** be replaced by an authorized technician. The sewing computer must be brought to an authorized BERNINA dealer!

Please refer to the safety instructions!

Trouble shooting

In most cases you will be able to identify and remedy faults by checking the following.

Check whether:

- the upper and lower threads are threaded correctly
- the needle is inserted as far up as possible with the flat side to the back
- the needle size is correct – check the needle/thread table
- the machine is clean – brush out any thread fluff
- the hook race is clean
- any threads are trapped between the tension discs or under the bobbin case spring

Upper thread breaks

- the upper thread tension is too tight.
- the needle is not designed to be used with the selected thread. Check the chart on page 65–66 and the Creative Consultant.
- the needle has been inserted incorrectly. The flat side of the shank must be to the back.
- the needle is bent or blunt.
- poor quality, knotted or dried out thread has been used.
- use the correct spool disc.
- stitch plate or hook tip damaged. Take your machine to your **BERNINA** dealer.

Lower thread breaks

- the lower thread tension is too tight.
- the bobbin is jamming in the bobbin case. Remove and replace the bobbin.
- the hole in the stitch plate has been damaged by the needle. This must be polished by a Bernina Certified Technician.
- the needle is blunt or bent.

Skipped stitches

- wrong needles used. Use only 130/705H system.
- the needle is blunt, bent or incorrectly inserted. Push right to the top when inserting.
- the needle point does not suit the fabric being sewn. If necessary use a ball point for knitted fabrics and cutting point for hard leather.

Needle breaks

- needle clamp screw loose.
- fabric taken out forwards instead of behind the presser foot.
- when sewing over thick area, the fabric was pushed with the needle still in the fabric.
- poor quality thread, unevenly wound or knotted.

Faulty stitching

- remnants of thread between the tension discs.
- remnants of thread under the bobbin case spring.
- the thread is still threaded in the finger of the bobbin case.
- incorrect threading. Check upper and lower threads.
- use the correct spool disc.

Machine fails to run or runs slowly

- plug not fully inserted.
- power switch in off (0) position.
- machine has been standing in a cold room.
- bobbin winder still switched on.

Machine sews in reverse

reverse sewing function is still activated.

Defective sewing light

Please note that it is forbidden to change the new CFL-sewing light by a unauthorized person. For Models with this new CFL-sewing light, the light can ONLY be replaced by an authorized Bernina Dealer.

Glossary of terms

check	· to preview the contents of a memory bank
clr (clear)	· remove or restore settings, back to basic settings
cursor	· on-screen positioning marker (vertical line) · used in memory for marking deletions, insertions, etc.
customized	· customer-oriented, individualized, personalized
Delete	· Delete/clear the previous command
edit	· alter, modify
esc (escape)	· close screen/program, return to previous or start screen
help	· an integrated program providing brief information and help concerning functions and specific stitches
memory	· sewing machine program to store stitches and combinations of stitches, letters and numbers for recall at any time
menu	· summary of program contents, e.g. stitches, functions from which selections can be made
ok	· to confirm a task or selection before continuing
outline	· stitches with outer contours which are not filled in
pattern	· motif, stitch
PC	· Personal Computer
PC Embroidery Software	· User friendly program designed especially for our customers · PC program for use in conjunction with our embroidery module to edit, mirror image and resize existing motifs. You can also use it to create and convert your own designs into beautiful embroidery.
scroll	· to move the screen up or down to view
Setup	· sequences and settings which can be altered and adapted to suit your personal preferences
smart	· program which saves the stitch and all settings in use during interruptions. Toggle between two stitches.
software	· computer programs
store	· save in memory for recall at any time
toolbar	· a term used for on-screen groups, e.g. functions
touch screen	· screen which operates the machine by touch
tutorial	· self-help program for learning about various machine features
update	· load new software onto machine
upgrade	· load new software onto machine

Index

A		E		G	
Accessory box	6	eco function	62	General functions	23
Alphabets/numbers	37–38	Editing functions	27	·esc	23
·alter size	37	·balance	27	·OK	23
·programming	38	·letter size	27	·Scroll down	23
Alphabet programming functions	28	·long stitch	27	·Scroll up	23
B		·mirror image	27	Glossary of terms	70
Balance	45	·motor speed	27	H	
Bobbin – winding, inserting	8	·pattern extend	27	Help program	46
Bringing up the lower thread	10	·securing end of stitch	27		
Bulb, replacing	68	·sub-division	27	L	
Buttonhole program functions	28	Embroidery cards	64	Letters/numbers	37–38
·button measurement	28	Embroidery module	63	M	
·direct length entry	28	External stitch buttons	20–21	Maintenance, cleaning	68
·manual buttonhole	28	·alphabet button	21	Memory	38–43
·stitch counter buttonhole	28	·buttonhole button	21	·Corrections in memory	41
Buttonholes	29–37	·decorative stitch button	21	·Deleting memory	43
·auto round and keyhole	31	·external connections	21	·Functions	40–41
·auto standard and stretch	30	·practical stitch button	20	·Open memory	38
·auto with direct length entry	31	·quilt stitches button	21	·Open individual memory	42
·buttonhole corrections	33	·Setup button	21	·Memory capacity	42
·long-term memory	34	External function buttons	22–23	·Programming stitches	39
·manual 4–6 step buttonholes	34–35	·clr button	22	·Programming stitches by number	39
·on-screen button measure	32	·eco button	22	·Programming with functions	40
·stitch counter buttonhole	32–33	·F (Favorite Function) button	23	·Save/leave memory	42
·straight stitch buttonholes	36	·Help	22	·Sub-division	43
Buttonholes, applications	17	·mem button	22	·View memory contents	41
Button sew-on program	36	·needle position	22	Messages, on-screen	29
C		·Needle stop adjustment	22		
Carrying case	6	·Pattern end	23	N	
Cleaning, maintenance	68	·Quick reverse button	22	Needle threader	10
Contents	3	·Setup button	22	Needle, changing	9
CPS program	62	·Smart button	22	Needle, thread, fabric feed	65–67
Creative Consultant	47–48	·TC button	22	Needle position, altering	19
·Fabric menu	48	Eyelet program	37	Needle stop	19
·Techniques menu	48	F		O	
D		F (Favorite function) button	54	Optional accessories	62–65
Details of the machine	4, 5	Fabric feed, thread, needle	65–67	P	
E		Feed dogs and fabric feed	67	PC Embroidery Software	64–65
eco function	62	Feed dogs	11	Power cable	7
Editing functions	27	FHS Free Hand System	7	Power switch	7
·balance	27	Foot control	7	Practical stitches, applications	16–17
·letter size	27	Functions, memory	26–27	Presser feet	15
·long stitch	27	·check	26	·Reverse pattern foot No.1	15
·mirror image	27	·delete	26	·Overlock Foot No. 2	15
·motor speed	27	·edit memory	27	·Buttonhole foot No.3	15
·pattern extend	27	·select memory	26	·Auto buttonhole foot No.3A	15
·securing end of stitch	27	·store	26	·Zipper foot No.4	15
·sub-division	27	·scroll left	26	·Blind stitch foot No.5	15
		·scroll right	27	·Embroidery foot No.6	15
		Functions in Setup	26, 50	·Jeans foot No.8	15
		Functions, on-screen selection	19		

Presser feet, special	15, 63	·Securing	24
Presser foot pressure	11	·Stitch selection by number	25
Presser foot, changing	9	·Vertical mirror image	25
Presser foot indicator	19	Touch screen selection	18–21
Programming letters/numbers	38	Troubleshooting	69
		Tutorial/Creative Consultant	47–48

Q

Quilt stitches	44
-----------------------	-----------

S

Safety instructions	1
Screen	18
Selecting on-screen functions	19
Setup	50–61
·Beeper	56
·Embroidery hoop adjustment	60
·F (Favorite function) button	54
·Functions, programming	53–55
·Functions in Setup	50
·Motor speed	56
·Needle position	55
·Personal program	51–53
·Return to basic settings	57
·Save and leave Setup	61
·Screen Calibration	59–60
·Screen Contrast	61
·Service	58
·Sewing light	58
·Start screen	57
·Stitch width, length	55
·Version Information	59
Sewing machine needles	65–66
Sewing table	7
Smart function	49
Standard accessories	6
Stitch width/length, altering	19
Stitch plate	11
Stitch selection, on-screen	19–20
Stitch selection by number	20
Stitch summary	13–14
·alphabets	14
·buttonholes	13
·decorative stitches	13
·practical stitches	13
·quilt stitches	14
Supplementary spool pin	9

T

Thread cutter	11
Threading upper thread	10
Thread, needle, fabric feed	65–67
Thread tension, altering	12
Touch screen functions	24–26
·Balance	25
·Clear All	25
·Continuous reverse sewing	25
·Double needle limitation	25
·Hemstitch (wing) needle	26
·Half pattern	25
·Horizontal mirror image	24
·Long stitch	24
·Motor speed	24
·Pattern begin	24
·Pattern end	24
·Pattern extension	25
·Scroll	25

Sewing Manual artista 165



2–5	Straight stitch, Zig-zag
6	Altered memory
7–11	Practical stitch seams
12, 13	Sewing knits
14	Zippers
15	Long stitch function
16	Basting stitch
17	Blind hem
18, 19	Elastic, cord
20	Bartack program
21–28	Buttonholes
29	Button sew-on program
30	Eyelets
31–34	Mending/darning
35	Decorative stitches
36	Cross stitches
37–39	Quilt stitches
40	Decorative stitches combined with functions
41–43	Practical and decorative stitches in memory
44	Balance
45	Index

Straight stitch

Stitch: **Straight Stitch No. 1**
 Needle: **size and type suitable for the fabric selected**
 Thread: **cotton or polyester**
 Feed-dog: **up (sewing position)**
 Presser foot: **Reverse pattern foot No. 1**
Jeans foot No. 8 (for sewing denim)

Straight stitch

- the machine is ready to sew as soon as it is turned on
- after the welcome screen (3 seconds), the machine automatically goes to the practical stitch screen with the pre-selected Straight Stitch highlighted

Screen

- suggests using Reverse pattern presser foot No.1
- basic settings (length and width) for Straight Stitch are preset at 2.25mm (length) and 0mm (width)
- basic settings as well as altered settings are always visible on the screen

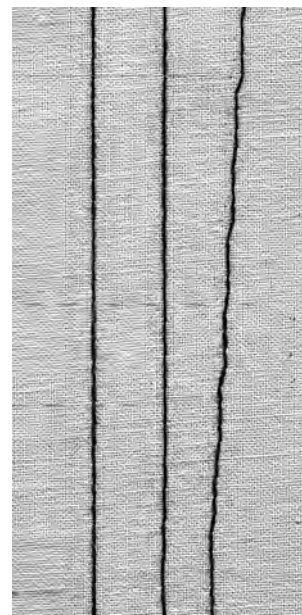

A B C

- A** straight stitch with length of 2.25 mm preset length
- B** straight stitch with altered stitch length
- C** straight stitch with altered needle positions

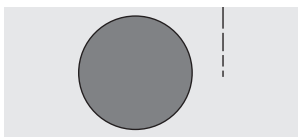

Alter the stitch length

- the stitch length can be altered while sewing
- turn the external stitch length knob to the right to lengthen
- turn the external stitch length knob to the left to shorten

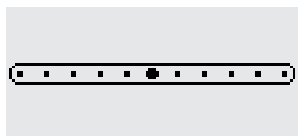

Change the needle position

- push the external needle position buttons to change the needle position so stitching can be placed exactly where it is desired
- each push of the button moves the needle one position in the direction of the symbol
- < five positions to the left
- > five positions to the right
- total of 11 positions, including center
- excellent for edgestitching, topstitching, and making tucks



Securing with Quick Reverse

- press the quick reverse button and the machine sews in reverse
- release the button and the machine sews forward



TIPS

Adjust the stitch length to suit the fabric:

- e.g. use a longer stitch length (approximately 3mm – 4mm) with denim, shorter length(2mm–2.5mm) with batiste

Adjust the stitch length to suit the thread:

- e.g. use a longer stitch length (approximately 3mm – 5mm) when sewing with cordonnet thread for top stitching

Activate needle stop down

- prevents the fabric slipping when you stop to adjust it

Securing stitch



Stitch: **Securing stitch No. 5**
 Needle: **size and type suitable for the fabric selected**
 Thread: **cotton or polyester**
 Feed-dog: **up (sewing position)**
 Presser foot: **Reverse pattern foot No. 1**

Securing program

- for all fabrics
- secures beginning and end of seam
- reverse stitching is exactly on top of the seam, preventing puckers

Stitch selection

- touch stitch No. 5
- quick reverse symbol will appear on-screen as a reminder to use it when ending the seam

Screen

- suggests using reverse pattern presser foot No.1
- basic settings (length and width) for Straight Stitch are preset at 2.5mm (length) and 0mm (width)

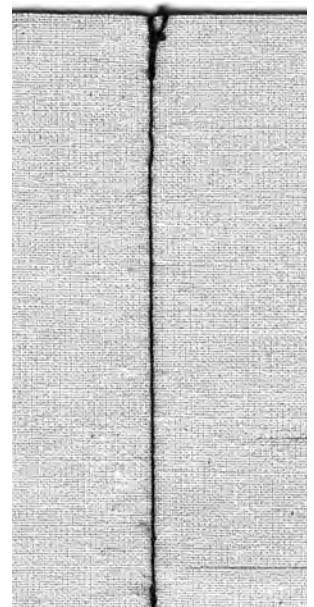

Beginning the seam

- machine secures the seam automatically (4 stitches forward, 4 stitches reverse)
- machine continues straight stitching

Ending the seam

- when coming to the end of the seam, press and release the quick reverse button above the needle
- machine will secure the seam automatically (4 stitches forward, 4 stitches reverse)
- machine stops automatically when securing is complete



TIP

Seaming

- quick and easy securing at beginning and end of seam

Edge stitching

Stitch: **Straight Stitch No. 1**
 Needle: **size and type suitable for the fabric selected**
 Thread: **cotton, polyester, or cordonnnet (topstitching)**
 Feed-dog: **up (sewing position)**
 Presser foot: **Reverse pattern foot No. 1 or Blindstitch Foot No. 5 or Edgestitch Foot No. 10 (optional accessory)**

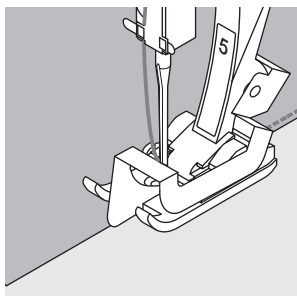

Narrow edge stitching

Needle position

- left for outer edge
- right for inner edge

Presser foot

- Blindstitch foot No. 5

Outer edge

- place finished or folded edge of fabric against the guide of the foot
- select needle position at desired distance from the edge

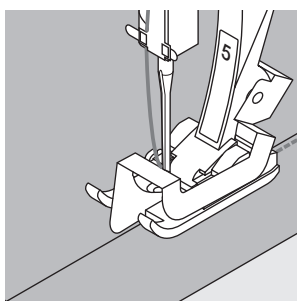

Hem edges

- place edge of fold (inside upper edge of hem) against the guide on the foot
- select a needle position that places the stitching along the upper edge of the folded hem
- Foot 5 – use any left or far right needle position
- Foot 10 – use any left or right needle position

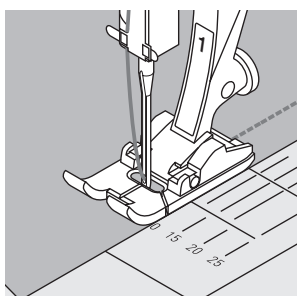

Wide edge stitching

Needle position

- any needle position can be used for this stitching
- different needle positions will place the stitching at various distances from the edge of the fabric

Presser foot

- reverse pattern foot No. 1

Guiding the fabric

Presser foot as a guide:

- align the edge of the presser foot with the finished or folded edge of the fabric

Stitch plate as a guide:

- guide the folded edge along the markings on the stitch plate for stitching 1cm–3cm from the edge

Quilting/Seam guide as a guide:

- insert the quilting/seam guide bar into the hole on the back of the presser foot shank
- adjust as desired, measuring from the needle
- tighten the screw
- guide the finished or folded edge of the fabric along the quilting/seam guide
- to sew parallel lines, guide the quilting/seam guide bar along a previously sewn line of stitching

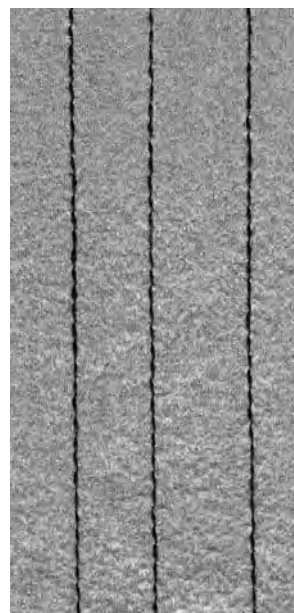
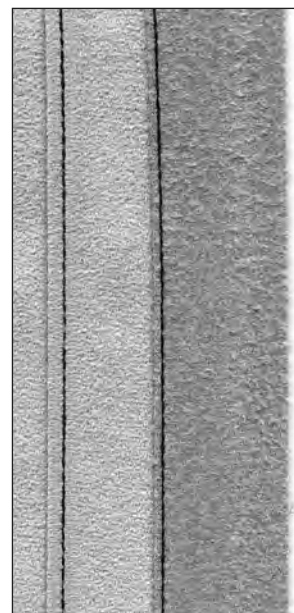
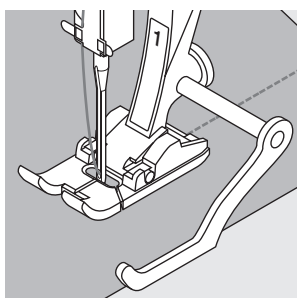

TIP

Edge stitching with quilting/seam guide

- eliminates tedious marking when sewing parallel lines or grids

Zig-zag stitch



Stitch: **Zig-zag No. 2**
 Needle: **size and type suitable for the fabric selected**
 Thread: **cotton or polyester**
 Feed-dog: **up (sewing position)**
 Presser foot: **Reverse pattern foot No. 1**

Zig-zag applications

- for all fabric types
- for finishing raw edges
- for decorative work

Stitch selection

- touch stitch No. 2

Screen

- suggests using reverse pattern presser foot 1
- basic settings (length and width) for Zigzag Stitch are preset at 1.5mm (length) and 3.5mm (width)
- basic settings as well as altered settings are always visible on the screen

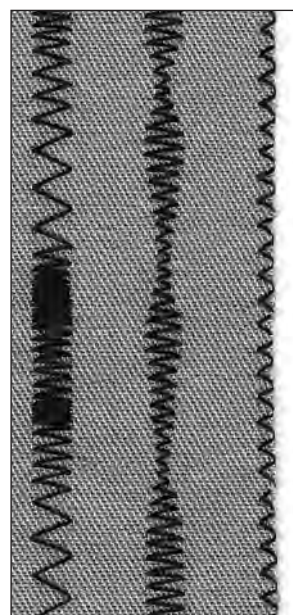

B **A** **C**

- A** zigzag stitch with altered stitch length
- B** zigzag stitch with altered stitch width
- C** fabric edges finished with zigzag stitch



Altering the stitch width

- the stitch width can be altered while sewing
- turn the external stitch width knob to the right to make the stitch wider
- turn the external stitch width knob to the left to make the stitch more narrow
- move the knob in a smooth, gentle rotation for a smooth tapering of the stitch

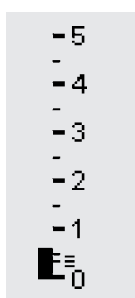

Alter the stitch length

- the stitch length can be altered while sewing
- turn the external stitch length knob to the right to lengthen
- turn the external stitch length knob to the left to shorten
- move the knob in a smooth, gentle rotation for a smooth transition of the stitch length



Satin stitch

- short stitch length setting indicated by parallel lines
- filled-in stitch used for applique, cutwork, embroidery, and other decorative applications

Oversewing edges

- good edge finish for most types of fabric
- guide edge of fabric into the center of the presser foot
- needle goes into fabric on one side and over the edge into the air on the other
- do not select too wide a width or too long a stitch – the edge should lie flat and not roll



TIPS

Oversewing edges with Zig-zag

- if edges roll, use the Vari-overlock stitch and foot No. 2

Embroidery with satin stitch

- experiment with adjusting the stitch width for new decorative effects

Altered Memory

Stitch:	Any selected stitch
Needle:	size and type suitable for the fabric selected
Thread:	cotton or polyester
Feed-dog:	up (sewing position)
Presser foot:	Reverse pattern foot No. 1

Altered Memory

- for all stitches and fabrics
- altered stitch length and width settings are saved automatically
- sew a stitch (e.g. zig-zag stitch)
- select and sew a second stitch (e.g. straight stitch)
- when the first stitch (zig-zag), is recalled, all altered settings remain
- particularly useful when alternating between two applications, such as seaming and edge finishing
- the altered memory can hold as many stitches as needed
- the altered memory is lost when the machine is turned off

Altering the basic settings

- select zig-zag stitch No. 2
- alter stitch width to 5mm
- alter stitch length to 1mm
- sew a line of the altered zigzag stitch
- select running stitch No. 4
- alter stitch width to 5mm
- alter stitch length to 1mm
- sew a line of the altered running stitch

Altered settings remain active

- select zig-zag stitch No. 2
- altered settings remain active
- sew a line of the altered zigzag stitch
- select running stitch No. 4
- altered settings remain active
- sew a line of the altered running stitch

Return to basic settings

- Method 1: press the external clr button
- Method 2: alter the stitch width and length manually
- Method 3: turn machine off – altered settings will *not* be saved

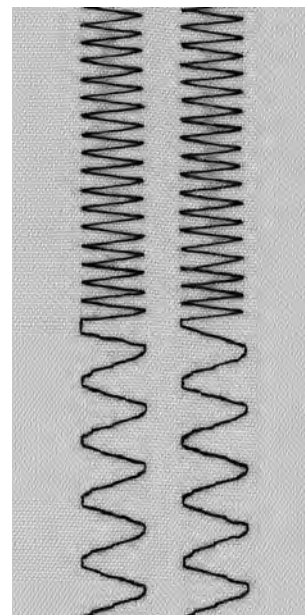

A B

A altered zigzag stitch changed to altered running stitch

B changed back to altered zigzag stitch and then changed again to altered running stitch



TIPS

Altering stitch width and length

- the width and length of all stitches can be adjusted to suit the fabric and type of sewing. Very convenient when sewing a project which may require using the same stitches repeatedly.

Changing Stitches

- alternating between sewing seams and finishing edges is easy with altered settings for many stitches, which remain altered once set

Practical stitch seams

Open seams

Seams which are pressed open

- seam allowance width as wide as desired
- seam lies flat
- seam does not stretch

Suggested stitches:

- straight, narrow zigzag, super stretch, and triple zigzag

Application:

- primarily for woven fabrics
- works for most types of sewing projects, including clothing, home accessories, and crafts

Closed seam (overlock seams)

Seams which cannot be pressed open

- sewn and finished in one operation
- narrow seam allowances

Suggested stitches:

- vari-overlock, double overlock, and jersey

Application:

- primarily for knits and jerseys
- excellent for knit clothing, lingerie, and bed linens

Flat joining seams

Seams where the edges are overlapped and then sewn

- stitching is on the seam allowances

Suggested stitch:

- stretch overlock

Application:

- particularly good for terry cloth
- also good for beachwear, leisure wear, and lingerie



Zig-zag seam



Stitch:	Zig-zag stitch No. 2
Stitch width:	approximately 1mm
Stitch length:	approximately 0.5mm
Needle:	universal, ballpoint, or stretch as needed
Thread:	cotton or polyester
Feed-dog:	up (sewing position)
Presser foot:	Reverse pattern foot No. 1

Open seam applications

- stitch has more "give" than a straight stitch
- use for knits, outer wear, children's knit clothes
- seam lies flat and is not bulky
- allows a garment to be let out

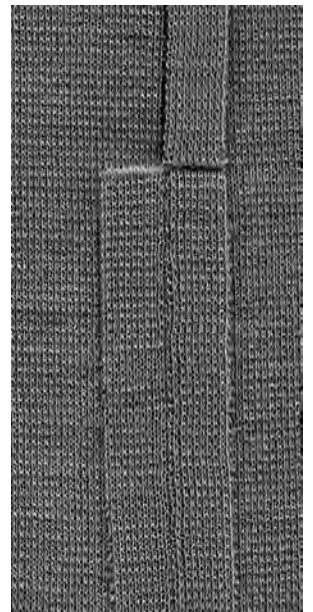

TIP

Prevent stretching

- to prevent the stretching of the seam while being sewn, reduce the presser foot pressure to suit the fabric

Triple Straight Stitch seam



Stitch: **Triple Straight Stitch No. 6**
 Needle: **80–90 universal or jeans**
 Thread: **polyester**
 Feed-dog: **up (sewing position)**
 Presser foot: **Reverse pattern foot No. 1**
Jeans foot No. 8

Open seam

- durable seam for firm and densely woven fabrics such as denim and corduroy
- reinforced seam for garment areas subject to hard wear

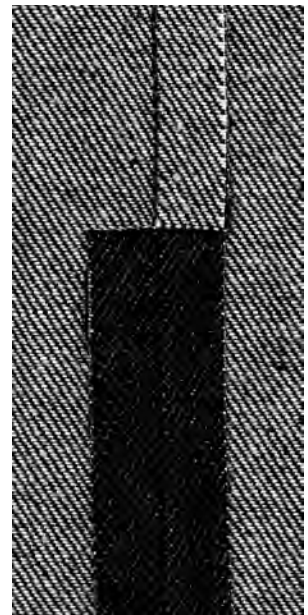

TIP

For heavy layers or very densely woven fabrics
 Use the height compensating tool to help foot sew smoothly and evenly when joining seams.

Stretch/Super stretch seam



Stitch: **Super stretch No. 11 or Stretch No. 18**
 Needle: **universal, ballpoint, or stretch as needed**
 Thread: **cotton or polyester**
 Feed-dog: **up (sewing position)**
 Presser foot: **Reverse pattern foot No. 1**

Open seam

- stretch seam for knit fabrics
- ideal for sports and leisure wear
- seam lies flat and is not bulky

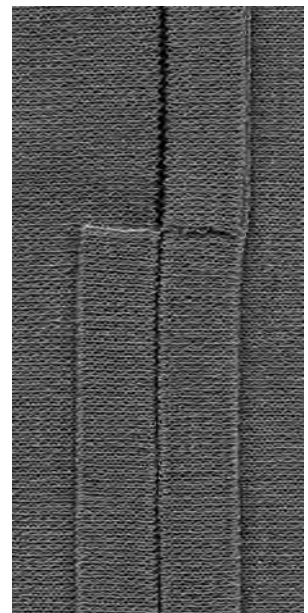

TIPS

Knits and jersey

- use a new needle to prevent damaging the fabric fibers

Sewing stretch fabrics

- if necessary use a stretch ball point needle (130/705H-S); needle point slides between the fibers

Prevent stretching

- to prevent the stretching of the seam while being sewn, reduce the presser foot pressure to suit the fabric

Vari-overlock seam



Stitch: **Vari-overlock No. 3**
 Needle: **size and type suitable for the fabric selected**
 Thread: **cotton or polyester**
 Feed-dog: **up (sewing position)**
 Presser foot: **Overlock foot No. 2**

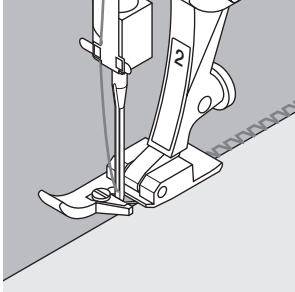

Closed seam

- stretchy seam in fine, soft knits such as silk jersey and interlock

Sewing

- guide the raw edge along the pin on the overlock foot
- the stitch will form over the pin and over the edge of the fabric

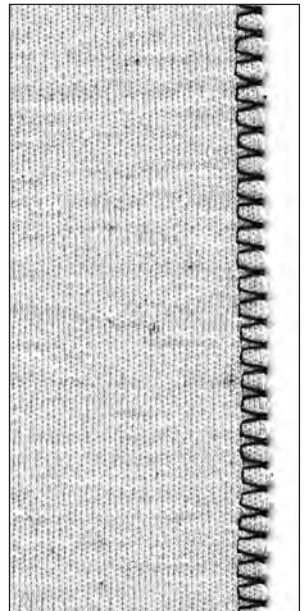

TIPS

Knits and jersey

- use a new needle to prevent damaging the fabric fibers

Sewing stretch fabrics

- if necessary use a stretch needle (130/705H-S); the point slides easily between the fibers

Double overlock seam/Jersey overlock seam



Stitch: **Double Overlock No. 10 or Jersey Overlock No. 20**
 Needle: **size and type suitable for the fabric selected**
 Thread: **cotton or polyester**
 Feed-dog: **up (sewing position)**
 Presser foot: **Overlock foot No. 2**

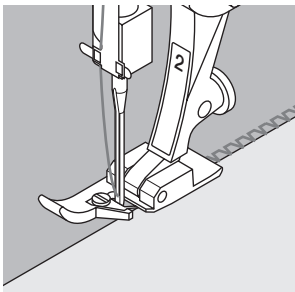

Closed seam

- overlock seam in loose knits and cross seams in knits and jerseys

Sewing

- guide the raw edge along the pin on the overlock foot
- the stitch will form over the pin and over the edge of the fabric

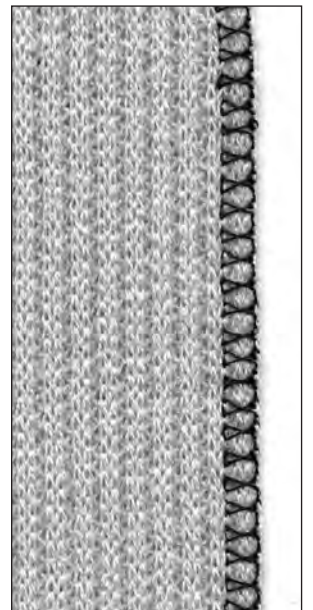

TIPS

Knits and jersey

- use a new needle to prevent damaging the fabric fibers

Sewing stretch fabrics

- if necessary use a stretch ball point needle (130/705H-S); the point slides easily between the fibers

Stretch overlock seam/Reinforced overlock seam

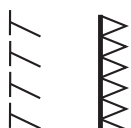

Stitch: **Stretch Overlock No. 13 or Reinforced Overlock No. 19**
 Needle: **universal, ballpoint, or stretch as needed**
 Thread: **cotton or polyester**
 Feed-dog: **up (sewing position)**
 Presser foot: **Reverse pattern foot No. 1 or Overlock foot No. 2**

Closed seam

- overlock seam in coarse or loose knits

Sewing

- sew stretch overlock along the fabric edge
- the stitch should go over the edge of the fabric on the right swing of the needle

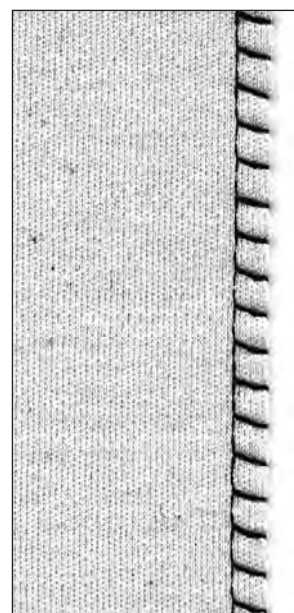

TIP

Prevent stretching

- to prevent the stretching of the seam while being sewn, reduce the presser foot pressure to suit the fabric

Flat joining seam

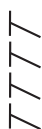

Stitch: **Stretch Overlock No. 13**
 Needle: **universal, ballpoint, or stretch as needed**
 Thread: **cotton or polyester**
 Feed-dog: **up (sewing position)**
 Presser foot: **Reverse pattern foot No. 1**

Flat joining seam

- fabric edges are overlapped and the stitch is placed on the seam allowance
- produces a very flat, durable seam
- ideal for fluffy, thick materials such as terry cloth, felt and leather

Sewing

- sew stretch overlock along the fabric edge
- the stitch should go over the edge of the top layer of fabric on the right swing of the needle



TIPS

Fabric and thread

- use a matching thread color, for less visibility in fluffy fabrics

Thick seam

- particularly suitable for fabrics in which a normal straight stitch seam would stretch open

Hems with practical stitches

Preparation

- fold and press hem; baste if desired

Sewing

- sew hem at desired depth (right side)
- trim excess fabric (wrong side)

Visible hem with Jersey stitch



Stitch: **Jersey stitch No. 14**
 Needle: **universal, ballpoint, or stretch as needed**
 Thread: **cotton or polyester**
 Feed-dog: **up (sewing position)**
 Presser foot: **Reverse pattern foot No. 1**

Visible stretch hem

- for all types of cotton, wool, synthetic and mixed fiber jerseys

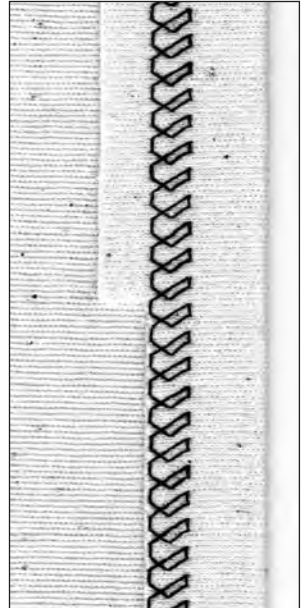

TIPS

Knits and jersey

- use a new needle to prevent damaging the loops of the knit fabric

Sewing stretch fabrics

- if necessary, use a stretch needle (130/705H-S); the point slides easily between the fibers

Visible hem with Triple Zig-zag



Stitch: **Triple Zig-zag No. 7**
 Stitch width: **2.5 mm – 5 mm depending on fabric**
 Stitch length: **basic setting**
 Needle: **universal or jeans**
 Thread: **cotton or polyester**
 Feed-dog: **up (sewing position)**
 Presser foot: **Reverse pattern foot No. 1**

Strong visible seam

- for firm, densely woven fabrics, particularly good for denim and canvas

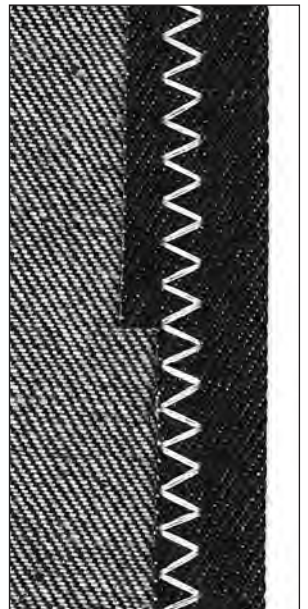

TIPS

Hems on fabrics which may ravel

- finish the raw edge of the hem; do not trim them after sewing

Sewing firm, hard fabrics

- use a jeans needle for better penetration

Sewing knits

Important tips for sewing knit fabrics

Start with a new needle

- blunt needles can damage knits

Use a stretch needle (130/705 H-S) if necessary

- the needle point slides easily between the fibers

Use a fine sewing thread

- coarse threads can damage knits and cause holes when the garment is washed

When basting, use a darning thread

- very lightweight (80 weight) darning thread is easier to remove once the seam is complete

Sew a test, when necessary

- the elasticity of knit fabrics varies greatly
- adjust basic settings to suit the fabric, the seam should be as stretchy as the fabric
- for greater elasticity:
 - use a shorter stitch length
 - use a wider stitch width
 (only one of these adjustments may be necessary)

Presser foot pressure

- soft, loose knits can wave when sewn: reduce the pressure until the seam lies flat the machine must still feed the fabric properly

Honeycomb stitch edges



- Stitch: **Honeycomb stitch No. 8**
 Needle: **universal, ballpoint, or stretch as needed**
 Thread: **cotton or polyester**
 Feed-dog: **up (sewing position)**
 Presser foot: **Reverse pattern foot No. 1**

Honeycomb stitch edges

- for all cotton, wool, synthetic and mixed fiber knits

Preparation

- turn the raw edge under by 1 cm ($\frac{3}{8}$ "); press and baste if desired

Sewing

- sew from the right side
- trim excess fabric from the wrong side



Balance/corrections

- Stitch is too open – make the stitch shorter by touching the “up” (↑) balance arrow several times
- Stitch is overlapping – make the stitch longer by touching the “down” (↓) balance arrow several times

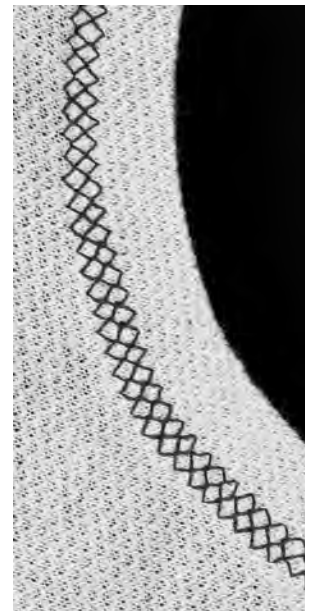

TIPS

Needle stop down

- needle stays in fabric when pivoting around curves (neck edges and armholes)

Presser foot pressure

- reduce pressure if hem stretches

Ribbing with overlock seam



Stitch: **Vari-overlock No. 3**
 Needle: **size and type suitable for the fabric selected**
 Thread: **cotton or polyester up (sewing position)**
 Feed-dog: **Overlock foot No. 2**
 Presser foot:

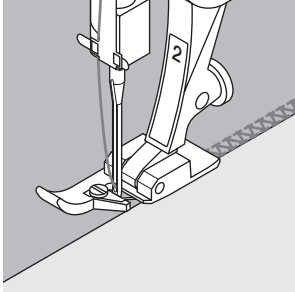

Ribbing with overlock seam

· for all fine cotton, synthetic and mixed fiber knits

Preparation

· fold ribbing in half
 · pin and baste to opening, front edge to outside

Sewing

· sew Vari-overlock over the raw edge
 · guide the raw edge along the pin of the foot
 · the stitch will form over the pin and over the edge of the fabric

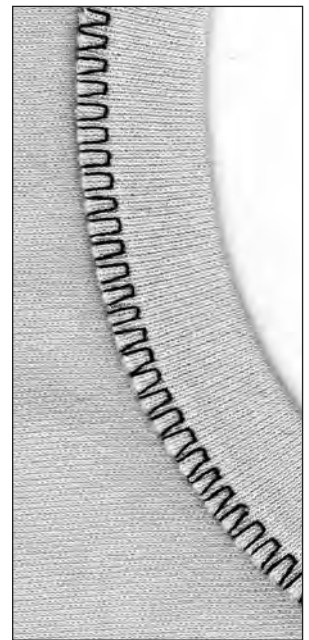

TIP

Needle stop down

· needle stays in fabric when you stop to adjust the ribbing on curves (neck edge, armholes)

Zippers

Stitch: **Straight stitch No. 1**
 Needle: **size and type suitable for the type of fabric selected**
 Thread: **cotton or polyester**
 Feed-dog: **up (sewing position)**
 Presser foot: **Zipper foot No. 4**
 Needle position: **far right or far left**

Preparation:

- baste or pin zipper in place
- fabric edges should meet over the center of the zipper

Sewing

- sew both sides of zipper from bottom to top
- needle position should be fully to the right on one side and fully to the left on the other
- edge of presser foot runs next to zipper teeth
- position the foot so the needle stitches along the edge of the zipper teeth

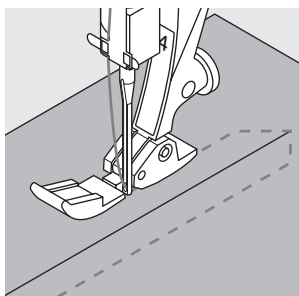

TIPS

To sew around the zipper pull

- close the zipper and sew up to about 5 cm (2") away from the pull
- stop with the needle down in the fabric, raise the presser foot. Open the zipper, pulling the tab below the needle; lower the foot and continue to sew

Starting to sew

- hold the thread firmly when starting to sew
- pull the fabric gently behind the needle for a few stitches

Dense fabric

- for even stitch formation, use a 90 or 100 needle

Long stitch function

This function works with the straight stitch to produce a longer than usual stitch.

The machine sews every second stitch when the Long stitch function is activated. The longest stitch possible is 10 mm when the stitch length is set at 5mm.

For decorative top stitching, the Long stitch function can be combined with Triple Straight stitch.

	Stitch:	Straight stitch No. 1 or Triple Straight Stitch No. 6
	Needle:	size and type suitable for the fabric selected
	Thread:	cotton or polyester
	Stitch length:	3.5 mm – 5 mm
	Feed-dog:	up (sewing position)
	Presser foot:	Reverse pattern foot No. 1
	Function:	Long stitch

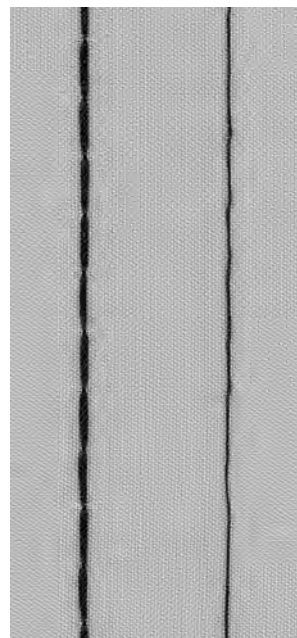

Long stitch

- for all work where a longer stitch is desired
- for topstitching

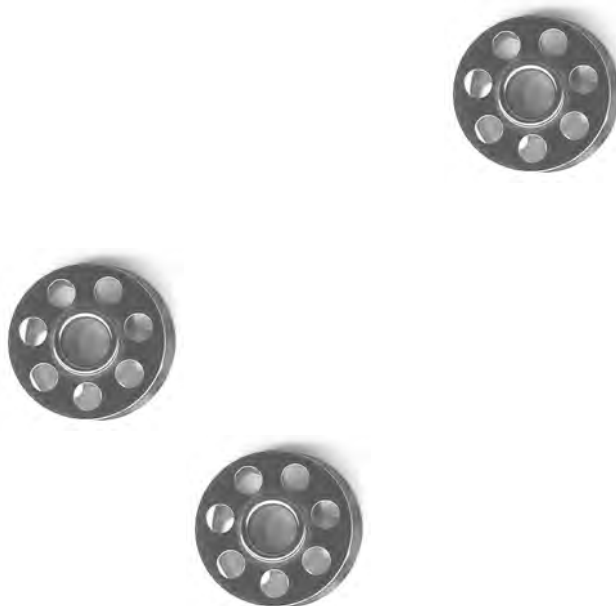

TIPS

Decorative top stitching

- use cordonnet (topstitching) thread and a 100–110 needle with the straight stitch

Basting

- long stitch can also be used to baste fine fabrics

Basting stitch

This feature is a stitch rather than a function (such as the long stitch). When this stitch (No. 21) is selected, the machine stitches a straight stitch, sewing every fourth one. The longest stitch possible is 20 mm when the stitch length is set at 5mm.

Stitch: **Basting stitch No. 21**
 Needle: **size and type suitable for the fabric selected**
 Thread: **cotton or polyester**
 Stitch length: **3.5 mm – 5 mm**
 Feed-dog: **up (sewing position)**
 Presser foot: **Reverse pattern foot No. 1**

Basting stitch

- for all work where a very long stitch is desired
- quick and easy basting of seams, hems, etc.
- easy to remove

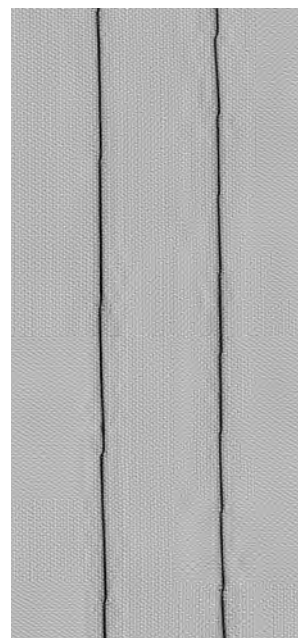

TIPS

Securing a basted seam

- to secure basting stitches, sew a few normal length straight stitches at the beginning and end of the seam

Basting

- use a fine darning thread; it is easier to remove after the seam has been sewn

Blind hem



Stitch: **Blindstitch No. 9**
 Needle: **size and type suitable for the fabric selected**
 Thread: **cotton, polyester, or silk**
 Feed-dog: **up (sewing position)**
 Presser foot: **Blindstitch foot No. 5**

Blind hem

- for invisible hems in medium to heavy cotton, wool and mixed fiber fabrics

Preparation

- finish the raw edges as desired
- fold the hem and baste or pin in place
- fold the garment back over the right side of the fabric to expose the finished lower edge
- place the work under the presser foot (see drawing) with the guide positioned against the folded back fabric

Sewing

- the needle should just pierce the edge of the fold
- adjust the stitch width to suit the fabric
- after sewing about 10 cm (4"), check both sides of fabric and adjust the stitch width if necessary

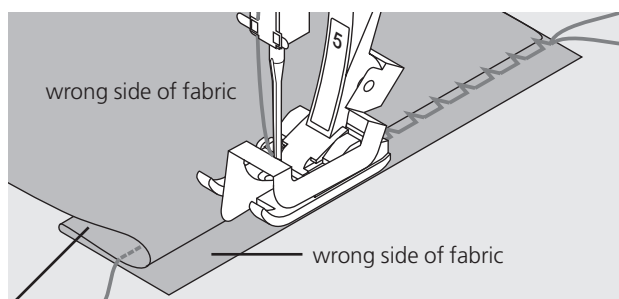

right side of fabric



TIP

Fine stitch width adjustment

- guide the raw edge along the guide on the foot to keep the stitch depth even

Sewing on narrow elastic with Universal stitch

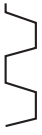

Stitch: **Universal stitch No. 15**
 Stitch width: **depends on width of elastic**
 Needle: **type and size to suit the fabric selected**
 Thread: **cotton or polyester**
 Feed-dog: **up (sewing position)**
 Presser foot: **Reverse pattern foot No. 1**
or Embroidery foot No. 6

Sewing on elastic

- for gathering long lengths of fabric, frills and flounces in fine fabrics
- works well for gathered sleeve edges and neck openings

Preparation

- cut elastic to length required

Sewing

- oversew the elastic, adjusting the stitch width to be slightly wider than the elastic
- needle must not pierce the elastic
- after sewing, adjust the gathers evenly

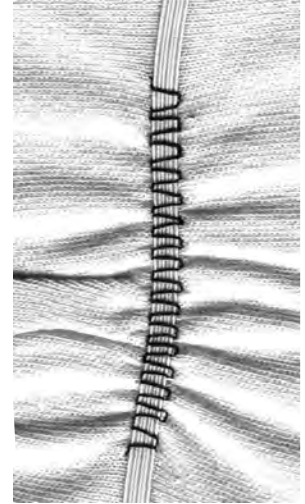

TIPS

Secure the beginning and end of elastic

- sew a few straight stitches backward and forward to secure the elastic

Quick hem finish

- for children's or doll clothing
- sew sleeve edges with elastic before sewing seams

Sewing on shirring elastic/cord with Gathering stitch



Stitch: **Gathering stitch No. 12**
 Needle: **size and type to suit the fabric selected**
 Thread: **cotton or polyester**
 Feed-dog: **up (sewing position)**
 Presser foot: **Buttonhole foot No. 3**

Shirring elastic/cord

- for gathering long lengths of fabric

Preparation

- cut shirring elastic or cord double the length of the edge
- fold in half lengthways
- hook over the center toe on the buttonhole foot
- take both ends of the cord under the foot to the back

Sewing

- sew a few stitches
- lift the elastic or cord at the front and pull towards you
- leave ends behind the presser foot
- oversew cord without stitching into it
- after sewing, pull the cord to gather the fabric
- stretch elastic while sewing; the more it is stretched, the tighter the gathers

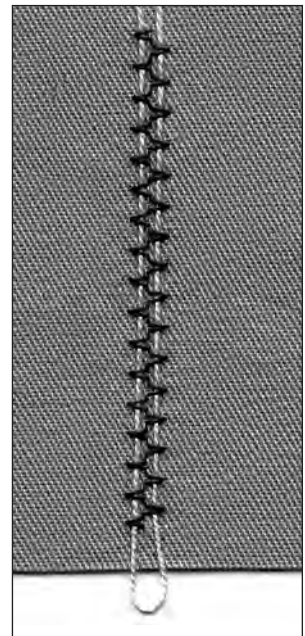

TIPS

Securing beginning and end

- sew a few stitches with the feed-dog lowered

Presser foot pressure

- increase the foot pressure, if necessary, for better feeding of the fabric and cord

Sewing on wide elastic



- Stitch: **Running stitch No. 4 or Sewn-out Zig-zag No. 16 or Lycra stitch No. 17**
 Stitch length: **adjust to suit elastic**
 Needle: **size and type to suit the fabric selected**
 Thread: **cotton or polyester**
 Feed-dog: **up (sewing position)**
 Presser foot: **Reverse pattern foot No. 1**

Wide elastic

- for edges on sportswear and lingerie

Preparation

- cut elastic to length required
- divide fabric edge and elastic into 4 equal sections and mark
- pin elastic to raw edge, matching markings

Sewing

- stretch the elastic to fit the raw edge while sewing
- trim excess fabric close to the stitching

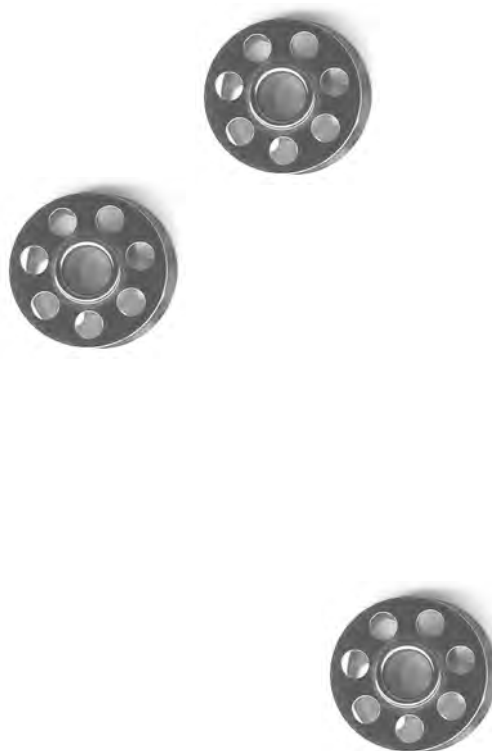
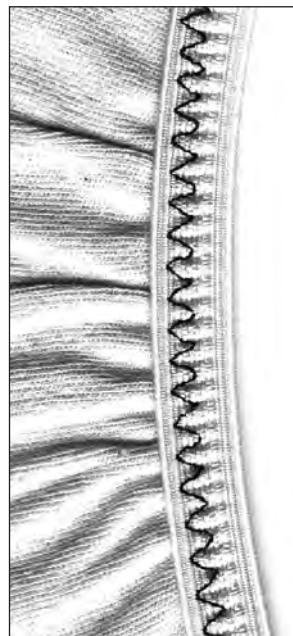

TIP

Preventing elastic from stretching too much

- avoid over-stretching the elastic; adjust the presser foot pressure to suit the fabric.

Bartack program



Stitch: **Bartack program No. 24 or Buttonhole bartack No. 25**
 Needle: **size and type to suit the fabric selected**
 Thread: **cotton, polyester, or rayon**
 Feed-dog: **up (sewing position)**
 Presser foot: **Reverse pattern foot No. 1**

Bartack program

- for reinforcing seams subject to heavy wear such as those on pockets, jackets, jeans, and overalls
- use for attaching ribbons to a quilt for tying

Buttonhole bartack

- for reinforcing buttonhole bartacks

Sewing

- the machine starts top left with the bartack program
- the machine stops automatically at the end of the program

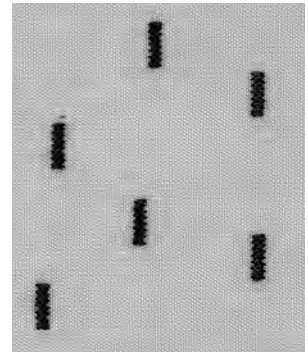

TIP

Decorative bar tacks

- increase the stitch length and sew the bar tack program with decorative thread as a decorative element; combine with other stitches

Important information on buttonholes

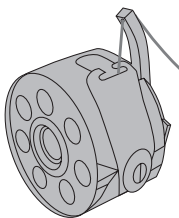

Thread tension

- thread the finger of the bobbin case
- the bobbin tension will be slightly tighter than normal
- this gives a slightly rounded appearance to the beads, making the buttonhole more attractive

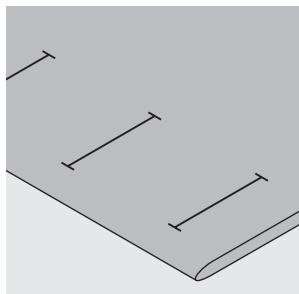

Manual buttonholes

- stitched using Buttonhole foot 3
- the buttonhole length of manually stitched buttonholes must be marked on the fabric in the appropriate position

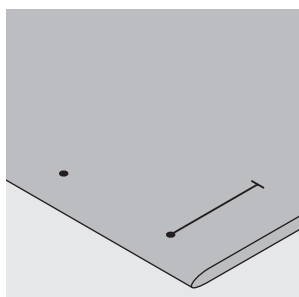

Automatic buttonholes

- stitched using Automatic buttonhole foot 3A
- mark the length of the first buttonhole
- after sewing the first buttonhole, the length for all subsequent buttonholes is automatically programmed
- mark the starting point of all subsequent buttonholes
- Buttonhole length = buttonhole opening in mm

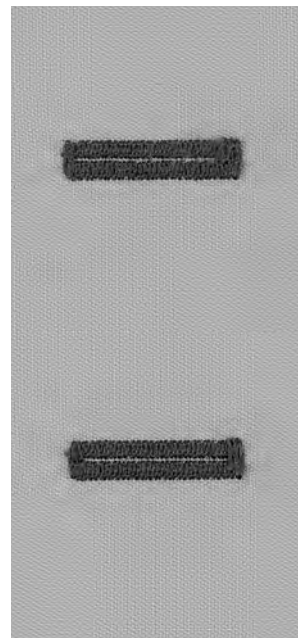

Test sewing

- always sew a test on the fabric(s) you will use with the same interlining, interfacing, and stabilizers
- select the same buttonhole type
- sew the buttonhole in the same direction on the fabric (with or against the grain)

Corrections

- To adjust the bead width:
- alter the stitch width

Altering the stitch length:

- any alterations to the stitch length affect both beads (making them more or less dense)
- *always stitch a new sample to reprogram the buttonhole after any changes are made to the stitch length*

Balance for automatic/manual buttonholes

- any balance alterations affect both beads

Balance for stitch counter buttonholes

- any balance alterations affect the *first* (left) bead:
 - *Bead too dense*– if the first bead looks like A, use the “down” arrow to correct it
 - *Bead not dense enough* – if the first bead looks like B, use the “up” arrow to correct it
- *always stitch a new sample to reprogram the buttonhole after any changes are made to the balance*



A



B

Clear balance

- press the external clr button

Corded Buttonhole

- gimp cord reinforces buttonholes and enhances their appearance
- the loop of the cord should be at the end of the buttonhole most subject to wear or where the button is sewn on
- position the work accordingly
- gimp cord is particularly recommended for standard and stretch buttonholes

Suitable cords:

- Perle yarn No. 8
- strong hand sewing thread
- fine crochet yarn
- gimp cord

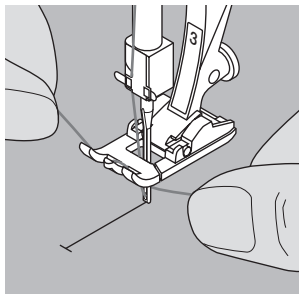
**Hooking the cord onto presser foot No. 3**

- insert the needle at the beginning of the buttonhole
- raise the presser foot
- hook the cord over the center toe of the foot

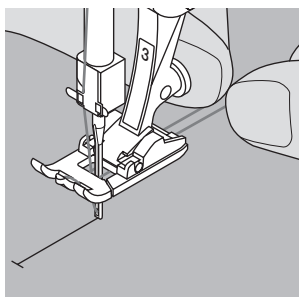

- place both ends of the cord in the grooves on the sole of the foot and pull them to the back
- lower the presser foot

Sewing

- sew the buttonhole in the usual manner
- do not hold the cord tightly
- the buttonhole will form over the cord, covering it

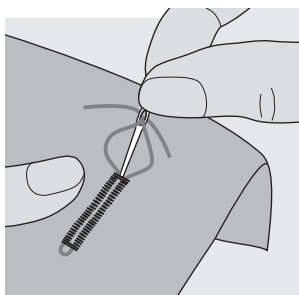
**Securing the cord**

- pull the cord through the buttonhole until the loop disappears into the end of it
- pull the ends of the cord through to back of the fabric
- knot or secure with stitches

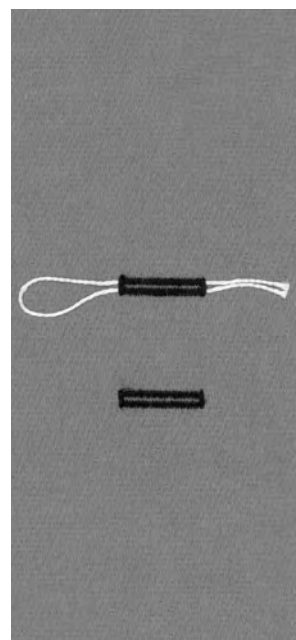

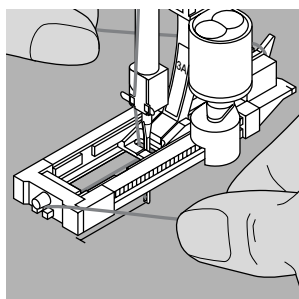

Hooking the cord in the automatic buttonhole foot No. 3A

- insert the needle at the beginning of the buttonhole
- raise the presser foot
- guide the cord under the foot to the right
- hook the cord over the pin at the back of the foot

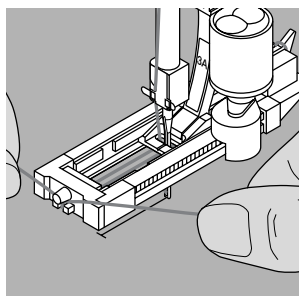

- bring the cords to the front of the foot
- pull each end into one of the notches at the front of the foot

Sewing

- sew the buttonhole in the usual manner
- do not hold the cord
- the buttonhole will form over the cord, covering it

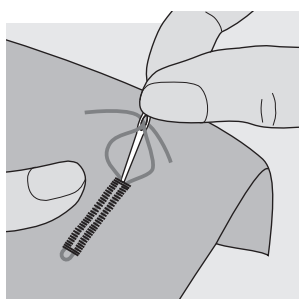

Securing the cord

- pull the cord through the buttonhole until the loop disappears into the end of it
- pull the ends of the cord through to back of the fabric
- knot or secure with stitches

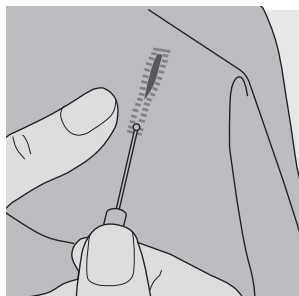

Cutting buttonholes open

- using the seam ripper, cut from the ends towards the middle

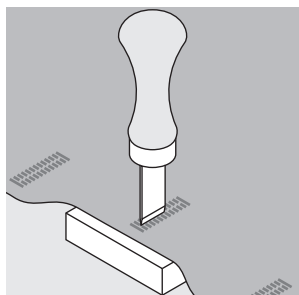

Buttonhole cutter and block (special accessory)

- place the fabric on a piece of wood
- place the cutter in the center of the buttonhole
- press the handle of the cutter to open the buttonhole

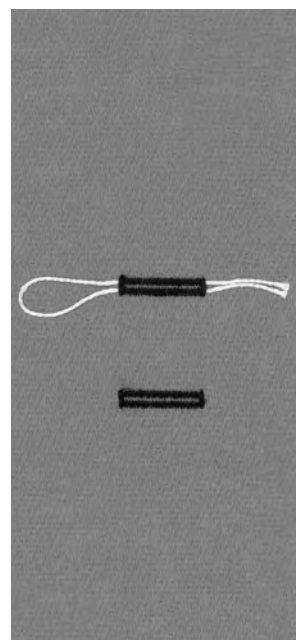

Straight stitch buttonholes

Straight stitch buttonholes are useful as a foundation for satin stitched buttonholes on soft and loosely woven fabrics that fray easily. The buttonhole beads and bartacks of the second (satin stitched) buttonhole will cover the straight stitching.

They are also good for stitching bound buttonholes and reinforcing buttonhole openings on leather, vinyl, and felt.



Stitch: **Straight stitch buttonholes No. 59**
 Needle: **size and type suitable for the fabric selected**
 Thread: **cotton or polyester**
 Feed-dog: **up (sewing position)**
 Presser foot: **Buttonhole foot No. 3 or Automatic Buttonhole Foot No. 3A**

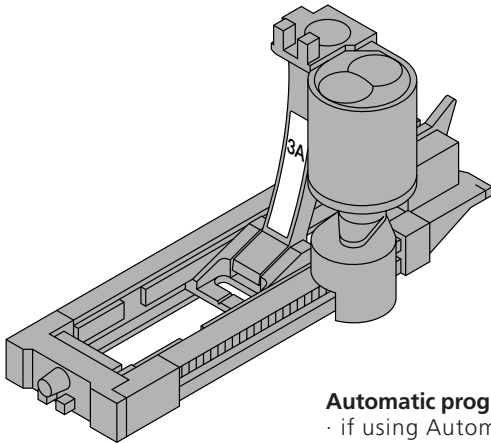

Automatic program with Automatic buttonhole foot No. 3A

- if using Automatic buttonhole foot No. 3A, the sensor on the foot will automatically register the length of the buttonhole so it can be duplicated

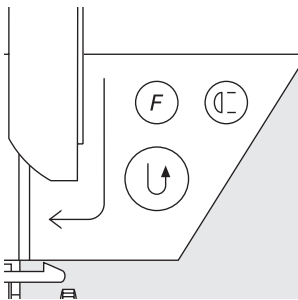
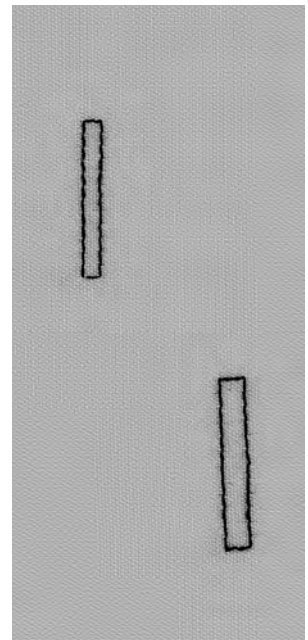

Sewing the automatic buttonhole program

- sew the first line of straight stitches forward until the desired length is reached
- press and release the quick reverse button
- auto appears = length is programmed
- machine completes the buttonhole program automatically
- all subsequent buttonholes will be stitched to the same length (without pressing the quick reverse button)
- the distance between the stitched lines can be adjusted with the stitch width

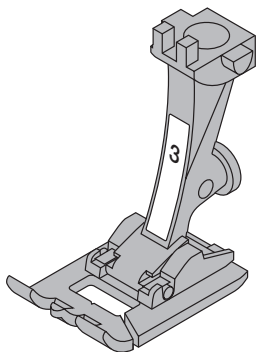

Stitch counter program with buttonhole foot No. 3

- select function presser foot 3 for stitch counter buttonholes
- Buttonhole foot No.3 will register the number of stitches in the buttonhole

Sewing the stitch counter buttonhole program

- sew the first bead, stop stitching at the desired length
- press and release the quick reverse button
- continue sewing; the machine will stitch the end of the buttonhole and then the second bead in reverse
- stop stitching when the needle reaches the first stitch
- press and release the quick reverse button
- machine sews the horizontal bar and securing stitches
- machine stops automatically
- auto appears on the screen
- each subsequent stitched buttonhole will be sewn to the same length as the programmed buttonhole

Automatic buttonholes (all types)

Both beads are sewn in the same direction
Buttonhole length = buttonhole opening in mm

Stretch buttonholes are particularly effective on all knit fabrics because the double overlock stitch used for the beads stretch with the fabric while keeping its shape.

Note: The automatic buttonhole foot No. 3A must lie perfectly flat on the fabric. If the foot lies on a seam, the length cannot be measured accurately.

Stitch: **Buttonhole (all types)**
Needle: **size and type suitable for the fabric selected**
Thread: **cotton or polyester**
Feed-dog: **up (sewing position)**
Presser foot: **Automatic buttonhole foot No. 3A**

Automatic buttonhole

- the lens on automatic buttonhole foot No.3A automatically registers the length of the buttonhole for exact duplication
- buttonholes from 4 – 29 mm can be sewn

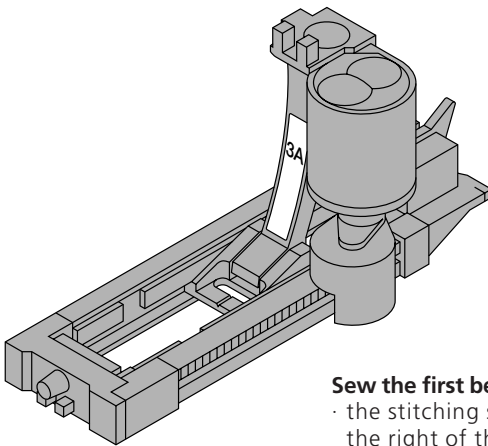

Sew the first bead

- the stitching sequence is displayed on the screen (to the right of the presser foot symbol)
- sew the first bead forward, stopping at the desired length

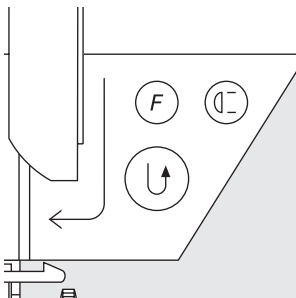

Program the buttonhole

- press and release the quick reverse button
- auto appears on the screen to indicate that the buttonhole length is programmed
- continue sewing; the machine completes the buttonhole and stops automatically

Auto buttonhole

- machine stops in position to begin the next buttonhole
- reposition the fabric and sew; all subsequent buttonholes will be sewn automatically to the same length (without pressing the quick reverse button)

Important:

- if you make a mistake, press the Pattern Begin function
- the machine reverts to the beginning of the buttonhole



TIPS

Exact duplicates

- the auto function ensures that each buttonhole will be exactly the same length as the previous one

Marking

- mark only the beginning of the buttonholes – a real time saver!

Sewing speed

- sew at moderate speed for best results
- sew all buttonholes at the same speed for a consistent bead density

Automatic round and keyhole buttonholes

Both beads are sewn in the same direction.
Buttonhole length = buttonhole opening in mm



Stitch: **Round buttonholes Nos. 54–55 and keyhole buttonholes Nos. 56–58**
 Needle: **size and type suitable for the fabric selected**
 Thread: **cotton or polyester**
 Feed-dog: **up (sewing position)**
 Presser foot: **Automatic buttonhole foot No. 3A**

Automatic buttonhole

- the lens on automatic buttonhole foot No.3A automatically registers the length of the buttonhole for exact duplication
- buttonholes from 4–29 mm can be sewn

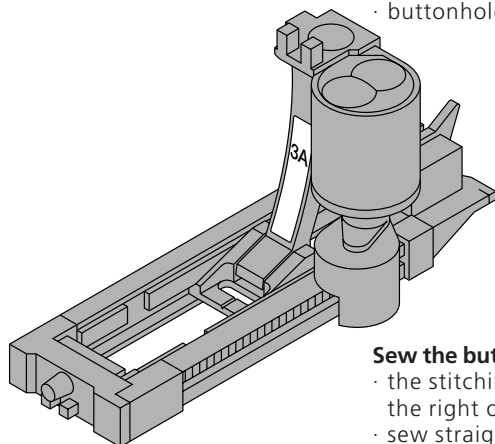

Sew the buttonhole

- the stitching sequence is displayed on the screen (to the right of the presser foot symbol)
- sew straight stitches forward, stopping at the desired length

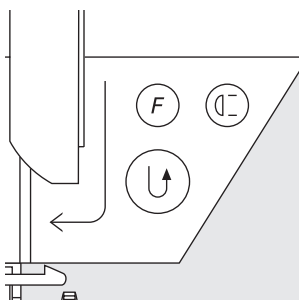

Program the buttonhole

- press and release the quick reverse button
- auto appears on the screen to indicate that the buttonhole length is programmed
- continue sewing; the machine completes the buttonhole and stops automatically

Auto buttonhole

- machine stops in position to begin the next buttonhole
- reposition the fabric and sew; all subsequent buttonholes will be sewn automatically to the same length (without pressing the quick reverse button)

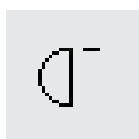

Important:

- if you make a mistake, press the Pattern Begin function
- the machine reverts to the beginning of the buttonhole

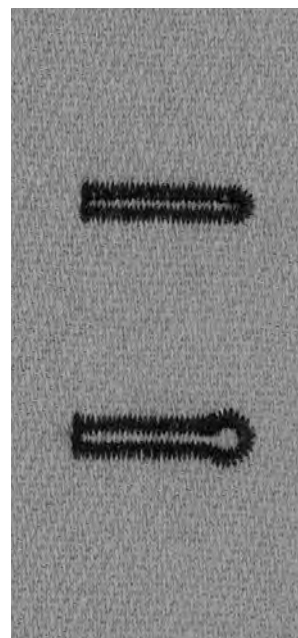

TIPS

Exact Duplicates

- the auto function ensures that each buttonhole will be exactly the same length as the previous one

Marking

- mark only the beginning of the buttonholes – a real time saver!

Double sewn keyhole buttonholes

- keyhole buttonholes can be sewn twice on thick fabrics
- after sewing the first buttonhole, do not move the work
- simply tap the foot control once to begin sewing again

Stitch counter buttonholes for all buttonhole types (can not be saved in memory)

Stitch: **Buttonholes (all types)**
 Needle: **size and type suitable for the fabric selected**
 Thread: **cotton or polyester**
 Feed-dog: **up (sewing position)**
 Presser foot: **Buttonhole foot No. 3**



Stitch counter buttonholes

- Select the stitch counter buttonhole function

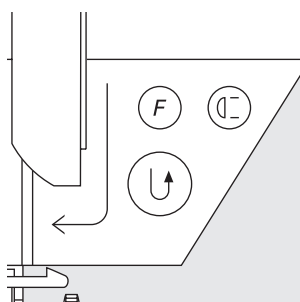

Length of first bead

- sew the first bead, stopping at the desired length
- press and release the quick reverse button

Bartack, second bead

- bottom bartack and second bead are sewn in reverse
- stop machine at the first stitch
- press and release the quick reverse button

Bartack, securing stitches

- machine sews the top bartack and securing stitches
- machine stops automatically
- auto appears on the screen
- the buttonhole is programmed and saved
- each subsequent buttonhole will be sewn identically

Corrections

- reprogram the buttonhole if any alterations to the stitch width, length, or balance have been made

Programmed buttonhole on a different fabric

- different fabrics and interfacings can affect the look of a stitch counter buttonhole
- if you are using a new material, program the buttonhole again

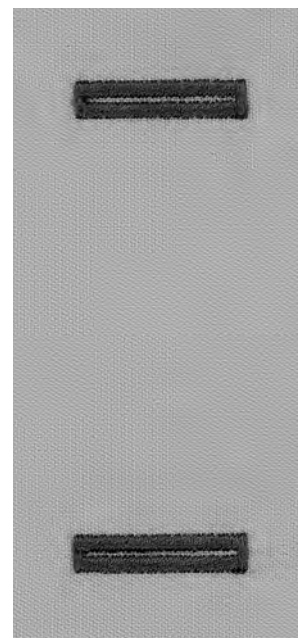

TIPS

More buttonholes with presser foot No. 3

- ideal for buttonholes which are difficult to sew with the larger foot of Automatic buttonhole foot No. 3A

Beautiful buttonholes

- keep the speed consistent for beads of equal density
- sew at a moderate speed for best results

Marking

- mark only the beginning of the buttonholes – a real time saver!

Manual 4/6-step buttonholes (all types)

Sewing buttonholes manually is ideal if you only need to sew one; also for repairing existing buttonholes.

The number of steps depends on the type of buttonhole. A manually sewn buttonhole cannot be saved.

Stitch: **any buttonhole**
 Needle: **size and type suitable for the fabric selected**
 Thread: **cotton or polyester**
 Feed-dog: **up (sewing position)**
 Presser foot: **Buttonhole foot No. 3**



Open the program

- select the type of buttonhole desired (stitches 51–59)
- select the manual buttonhole function from the toolbar

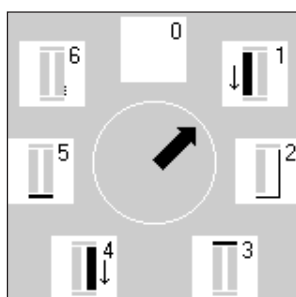

Step symbols

- the step sequence is shown on the screen:
 - standard buttonhole has 6 steps
 - round buttonhole has 4 steps
 - keyhole buttonhole has 4 steps
- the arrow in the circle is on "0" when the buttonhole is first selected

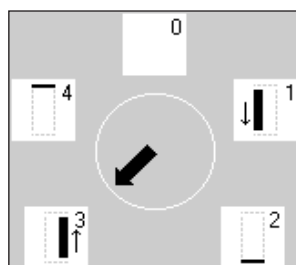

Sewing a 4 or 6 step buttonhole

- touch 1 on the screen and sew the first bead
- stop the machine at the desired length
- touch 2, sew
- continue in this manner until the buttonhole is complete

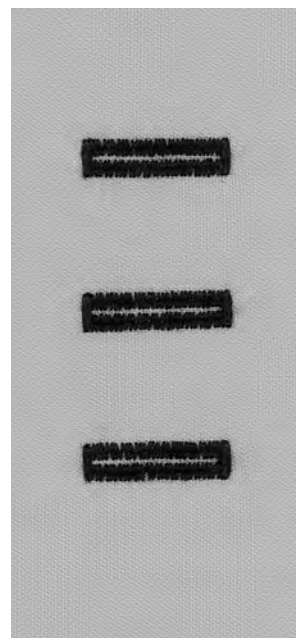

TIP

Repairing buttonholes

- use the steps which are necessary to repair the worn sections, omitting or bypassing the unneeded ones

Button sewing-on program



Stitch: **Button sew-on program No. 60**
 Stitch width: **depends on the distance between the holes**
 Needle: **size and type suitable for the fabric selected**
 Thread: **cotton or polyester**
 Feed-dog: **down (darning position)**
 Presser foot: **Button sew-on foot No. 18 (optional accessory)**

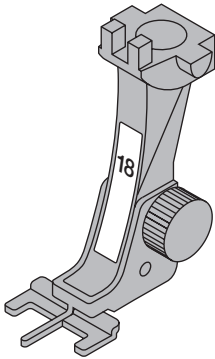

Button sew-on program

- sews buttons with 2 and 4 holes
- the shank (thread length between button and fabric) can be made shorter or longer as required
- buttons being sewn on for decorative purposes only can be stitched without forming a thread shank



2-hole button

- select Button Sew-on program
- check distances between holes with the handwheel
- adjust stitch width if necessary
- hold the threads when starting to sew
- sew; machine stops automatically when program is completed
- machine is automatically ready for the next button

Beginning and ending threads

- the threads are secured and can be trimmed

For secure results:

- cut the upper thread close to the button
- pull both bobbin threads until the upper thread is visible on the wrong side
- trim bobbin thread (knot if desired)

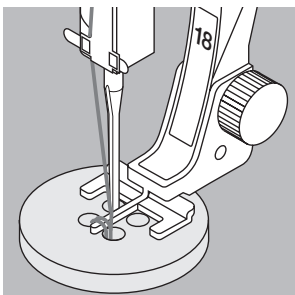

4-hole button

- sew the front holes
- carefully move the button forward
- sew the back holes



TIPS

Sewing on buttons by machine

- a real time saver, especially when several of the same type buttons must be sewn on, e.g. shirts, blouses, etc.

Shortening zippers

- a zipper which is too long can be secured simply and quickly using the button sew-on program

Zigzag Eyelets



Stitch: **Zig-zag Eyelet No. 61**
 Needle: **size and type suitable for the fabric selected**
 Thread: **cotton, polyester, or rayon**
 Feed-dog: **up (sewing position)**
 Presser foot: **Reverse pattern foot No. 1**

Zig-zag Eyelet

- ideal opening for cords and narrow ribbons
- attractive decorative elements for clothing, crafts, etc.
- *cannot* be programmed into memory

Sewing eyelets

- select eyelet stitch No. 61
- position fabric under the presser foot and sew
- machine stops automatically when finished
- machine is automatically ready for the next eyelet

Punching eyelets

- use an awl or punch to cut open the eyelet

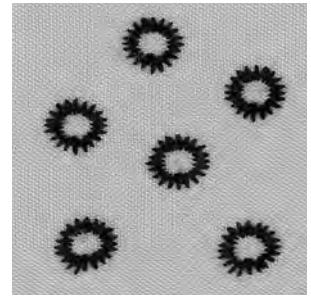

Straight Stitch Eyelets



Stitch: **Straight Stitch Eyelets No. 62**
 Needle: **size and type suitable for the fabric selected**
 Thread: **cotton, polyester, or rayon**
 Feed-dog: **up (sewing position)**
 Presser foot: **Reverse pattern foot No. 1**

Straight Stitch Eyelet

- ideal opening for cords and narrow ribbons
- attractive decorative elements for clothing, crafts, etc.
- *cannot* be programmed into memory

Sewing eyelets

- select eyelet stitch No. 62
- position fabric under the presser foot and sew
- machine stops automatically when finished
- machine is automatically ready for the next eyelet

Punching eyelets

- use an awl or punch to cut open the eyelet

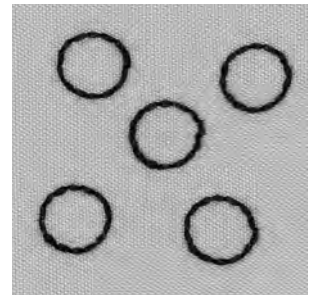

TIPS

Eyelets

- ideal for eyes on soft toys, dolls and puppets

Decorative eyelets

- use decorative thread to introduce an attractive element when combined with other embroidery or decorative stitches

Elastic Edges



Stitch: **Zig-zag stitch No. 2**
 Stitch width: **approximately 5mm**
 Stitch length: **1 mm – 1.5 mm**
 Needle: **size and type suitable for the fabric selected**
 Thread: **cotton or polyester**
 Feed-dog: **up (sewing position)**
 Presser foot: **Reverse pattern foot No. 1**

Elastic edges

- use on knit garments to re-form out-of-shape edges

Sewing

- guide double length of shirring elastic along the edge of the fabric, stretching the elastic slightly
- oversew the elastic with a zig-zag stitch
- do not sew through the elastic, only over it
- adjust elastic after sewing is complete to regain the correct shape and size

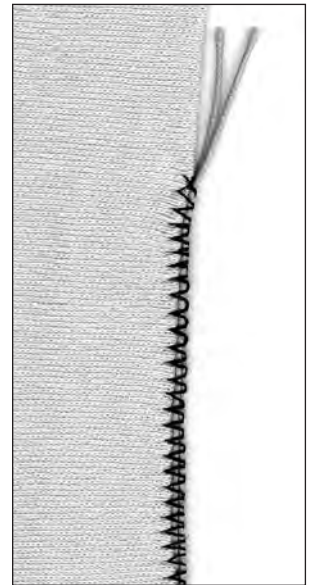

TIP

Prevent fabrics stretching

- To prevent the fabric from stretching as it is sewn, reduce the presser foot pressure to suit the fabric

Reinforced edges on woven fabrics

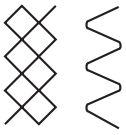

Stitch: **Honeycomb stitch No. 8 or Running stitch No. 4**
 Needle: **size and type suitable for the fabric selected**
 Thread: **lightweight darning thread**
 Feed-dog: **up (sewing position)**
 Presser foot: **Reverse pattern foot No. 1**

Reinforcing edges

- good for work clothes, table linen, towels, etc.
- use a cord to match the color of the fabric

Suitable cords

- perle yarn
- fine crochet yarn
- strong hand-sewing thread
- gimp

Sewing

- oversew edges with Honeycomb or Running stitch
- oversew a cord along the edge for added reinforcement
- if necessary, sew a second row somewhat in from the edge

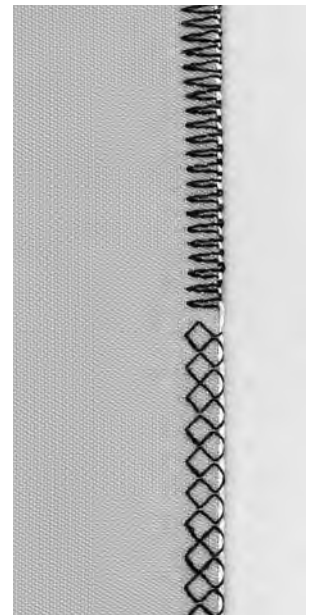

Patches on knits and jersey



Stitch: **Jersey stitch No. 14**
 Needle: **size and type suitable for the fabric selected**
 Thread: **lightweight darning thread**
 Feed-dog: **up (sewing position)**
 Presser foot: **Reverse pattern foot No. 1**

Covering worn or damaged areas

- particularly suitable for stretchy fabrics, lingerie

Preparation

- do not cut damaged area
- round off the edges of the patch to retain flexibility
- pin and baste to right side

Sewing

- place patch over worn area
- sew over edge
- sew a second row inside the first if desired
- cut away damaged area

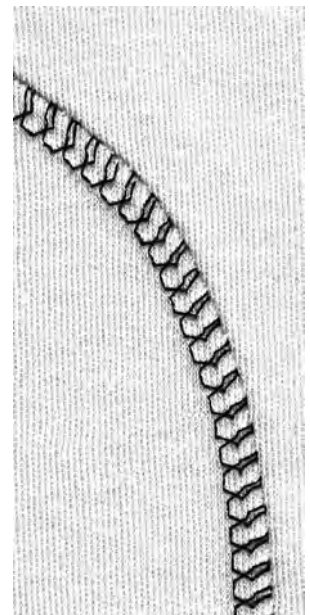

TIPS

Knits

- use a new needle to prevent damage of the fabric loops

Sewing stretch fabrics

- if necessary use a stretch needle (130/705 H-S); point slides easily between the fibers

Prevent stretching

- to prevent the stretching of the seam while being sewn, reduce the presser foot pressure to suit the fabric

Automatic darning



- Stitch: **Simple Darning Program No. 22 or Reinforced Darning Program No. 23**
- Needle: **size and type suitable for the fabric selected**
- Thread: **lightweight darning thread**
- Feed-dog: **up (sewing position)**
- Presser foot: **Automatic buttonhole foot No. 3A
Reverse pattern foot No. 1**

Preparation

- stretch fine fabrics into a darning or embroidery ring to prevent distortion

Simple Darning Program No. 22

- replaces threads along the lengthwise grain in all fabrics
- use with Reverse pattern foot No. 1
- touch foot 3 on the toolbar across the lower part of the screen
- sew the first row
- press and release the quick reverse button at the desired length; this programs the first length
- sew the second row
- press and release the quick reverse button; this programs the second length
- continue sewing; the machine stops automatically



Reinforced Darning Program No. 23

- replaces threads along the lengthwise and crosswise grains in all fabrics
- use with Automatic buttonhole foot No. 3A
- insert the needle in the top left of the worn area
- sew the first vertical row
- press and release the quick reverse button at the desired length; this programs the length needed
- continue sewing; the machine stops automatically when finished

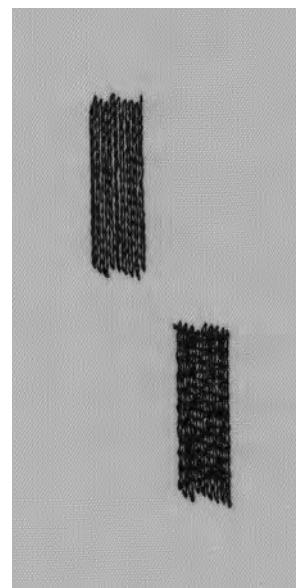

Large areas

- reposition the work under the foot to continue covering the worn area
- begin sewing; the program will repeat (length is saved)

Corrections

- if the darning becomes distorted, correct with the Balance function (see page 44)



TIPS

Reinforced darning

- place a piece of gauze under the worn area before darning

Large areas

- increase the darning area lengthwise and crosswise by moving the work under the foot

Manual darning

Stitch:	Straight stitch No. 1
Needle:	size and type suitable for the fabric selected
Thread:	lightweight darning thread
Feed-dog:	down (darning position)
Presser foot:	Darning foot No. 9 (optional accessory)

Darning holes or worn areas

- replaces threads with the lengthwise and the crosswise grains in all fabrics

Preparation

- stretch fabric into darning ring (optional accessory) to prevent distortion
- use of the slide-on sewing table is recommended

Sewing

- move the darning ring smoothly and without using pressure
- work from left to right

Stitch over the hole

- sew the first rows to cover the hole (not too close)
- turn work by a quarter turn – 90°

Cover the first rows

- sew over the first rows – not too close for a soft finish
- turn work by a half turn – 180°

Complete darning

- loosely and in same direction as 2nd rows

Method for tubular items

- first step in a horizontal direction
- second and third steps in lengthways direction

When you have mastered the technique

- work the rows in irregular lengths so that the turns are "lost" in the fabric

Stitching hints

- move the hoop as if writing the letters "L" or "M"
- when changing direction, move in curves, avoiding points
- this prevents holes and thread breakage
- do not sew in circles; these do not mimic the fabric threads

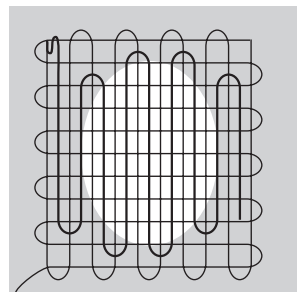
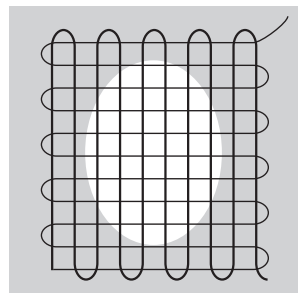
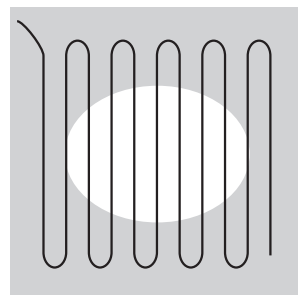
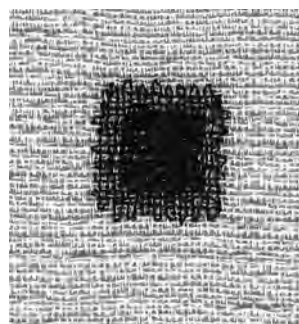
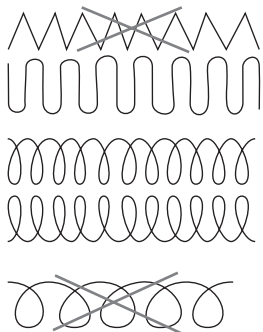

TIPS

Thread breaks

- if thread breakage is a problem, it could be that the ring is not being moved smoothly

Poor stitch formation

- if the thread is lying on top of the fabric, the ring is being moved too quickly
- if there are knots on the underside of the fabric, the ring is being moved too slowly

Decorative stitches

- Stitch: **Any decorative stitch**
 Needle: **embroidery needle in a size suitable for the fabric selected**
 Thread: **cotton or rayon embroidery up (sewing position)**
 Feed-dog: **Reverse Pattern foot No. 1 or Embroidery foot No. 6 or Open embroidery foot No. 20 (optional accessory)**
 Presser foot:

Decorative stitches

- for all fabrics
- for embellishing and decorative work

Stitch selection

- press the external menu button for Decorative stitches
- select the desired stitch group from the screen (groups 100, 300, 400, 600, 700, and 900 are 5mm stitches)
- select the desired stitch

Screen

- selected stitch is highlighted
- suggests foot No.1; use foot No. 6 or No. 20 for heavy, compact stitches
- basic settings (length and width) are automatically set, but can be altered



Altering the stitch width

- alter the look of the stitch by adjusting the width
- turn the external stitch width knob to the right to widen the stitch
- turn the external stitch width knob to the left to narrow the stitch
- both the basic settings and the altered settings will be visible on the screen

-5
-
-4
-
-3
-
-2
-
-1
-
=0

Altering the stitch length

- alter the look of the stitch by adjusting the length
- turn the external stitch width knob to the right to lengthen the stitch
- turn the external stitch width knob to the left to shorten the stitch
- both the basic settings and the altered settings will be visible on the screen

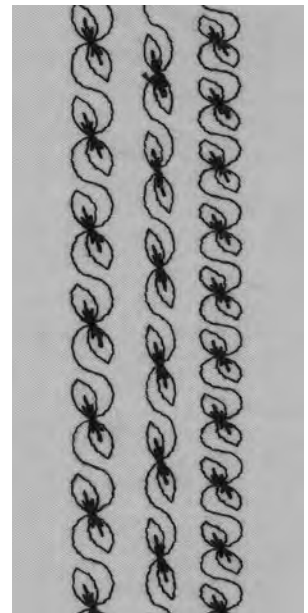

A B C

- A** decorative stitch with preset width and length
- B** decorative stitch with reduced width
- C** decorative stitch with shortened length



TIP

Altering the basic settings

- the stitch can be adjusted as desired
- adjust the size of the stitch to suit the size of the item being sewn, e.g. reduce the width for small items such as doll clothes

Cross stitches

Stitch: **Cross stitches Nos. 301–309, 314 or Cross stitch No. 310**
 Needle: **size and type suitable for the fabric selected**
 Thread: **cotton or rayon embroidery up (sewing position)**
 Feed-dog: **Reverse pattern foot No. 1 or**
 Presser foot: **Open embroidery foot No. 20 (optional accessory)**

Cross stitch

- a useful and attractive addition to sewing projects of all types
- combine cross stitches with other decorative stitches

Sewing

- sew and combine stitches 301–309, 314 in the same manner as all other decorative stitches

310



Large cross stitch No. 310 (1st section)

- sew the first section
- machine stops automatically in the center
- the machine stops with the needle down in the fabric *even if the needle stop indicates "up"*

310

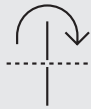

- a curved arrow appears on the screen next to the needle stop indicator
- the arrow is a reminder to turn the fabric 90° before stitching the second part of the stitch

Large cross stitch No. 310 (2nd section)

- sew the second section
- the machine stops automatically at the end and is ready to begin the next cross stitch

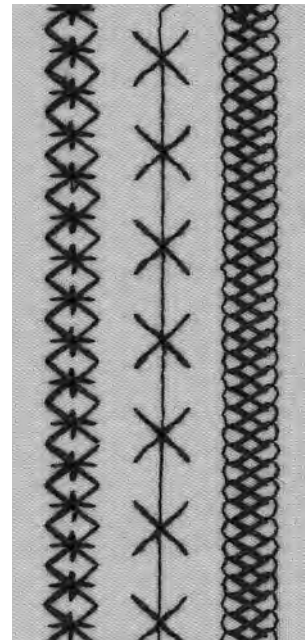

TIPS

Cross stitch with embroidery thread

- stitches appear fuller

Cross stitch on a single layer

- always use stabilizer
- remove stabilizer after sewing

Hand-look quilt stitch

Stitch:	Quilt stitch No. 328, 346–350
Needle:	size and type suitable for the fabric selected
Upper thread:	monofilament
Bobbin thread:	30 weight, 2 ply cotton
Feed-dog:	up (sewing position)
Presser foot:	Reverse pattern foot No. 1 or Walking foot No. 50 (optional accessory)

Hand-look quilt stitch

- for all fabrics and all types of work where the look of a hand sewn running stitch is desired

Sewing test

- the bobbin thread comes through to the top of the fabric
- 1 stitch is visible (cotton thread), 1 stitch is invisible (monofilament thread) to give a hand stitched effect

Upper thread tension

- the upper thread tension is set automatically
- adjust if necessary to suit the fabric

Balance

- adjust if necessary

Sewing

- can be sewn with any needle position

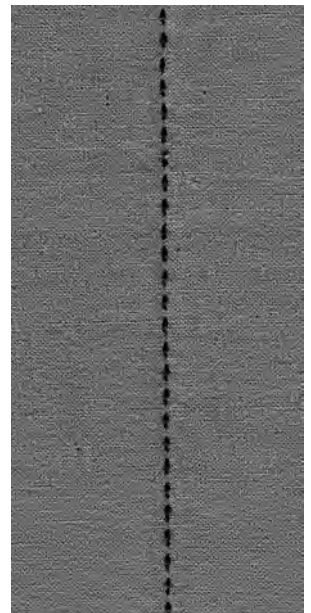

TIPS

Perfect corners

- activate Pattern end when approaching corner; when the machine stops automatically, sink the needle (if needed) and pivot the work

Monofilament hints

- if the monofilament thread breaks, sew more slowly and/or reduce the upper thread tension slightly

Decorative quilt stitches

Stitch: **Quilt stitches Nos. 326–338, 351**
 Needle: **size and type suitable for the fabric selected**
 Thread: **cotton or rayon embroidery**
 Feed-dog: **up (sewing position)**
 Presser foot: **Reverse pattern foot No. 1**

Straight stitch No. 326

- a short straight stitch (2mm)
- particularly suitable for piecing patchwork

Quilt stitches

- suitable for all fabrics and quilting
- especially applicable for crazy quilting

Balance

- adjust if necessary

Sewing

- select quilt stitch and sew
- all quilt stitches can be combined and programmed in memory

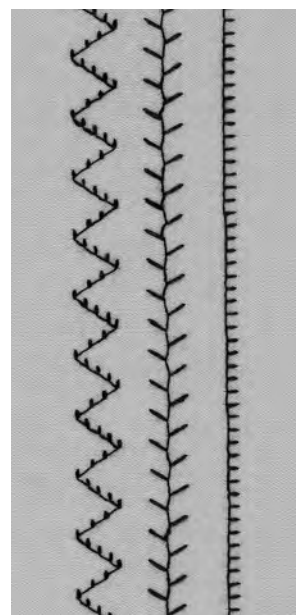

TIP

Perfect corners

- activate Pattern End; when the machine stops automatically, sink the needle (if needed) and pivot the work

Freehand quilting

- Stitch: **Straight stitch No. 1**
 Needle: **size and type suitable for the fabric selected**
 Thread: **cotton or monofilament**
 Feed-dog: **down (darning position)**
 Presser foot: **Darning foot No. 9 (optional accessory) or Quilting foot No. 29 (optional accessory)**

Freehand quilting

- for all freehand quilt work

Preparation

- pin and baste top layer, batting, and lining together
- attach the slide-on sewing table or place machine in a cabinet

Holding the work

- start in the center and work out toward the edges
- hold the fabric with both hands like an embroidery frame

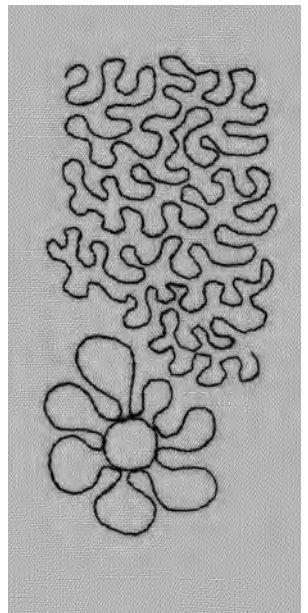
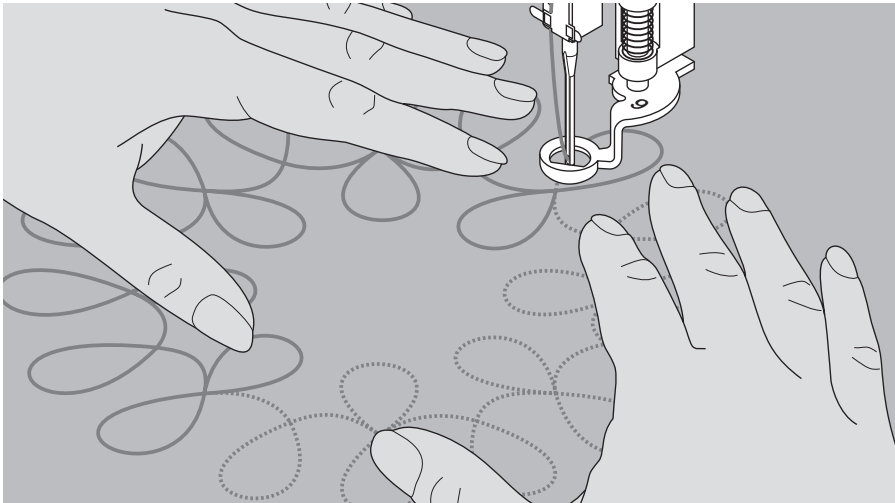

Quilting a design

- turn the work using smooth, round movements to form the design of your choice (either freehand or following a template)

Stipple quilting

- this technique covers the entire surface of the fabric
- the lines of stitching are rounded without any sharp corners; they never cross or touch one another



TIPS

Freehand quilting and darning

- both techniques are based on the same free-motion principles

Thread breaks

- usually as a result of sudden or jerky movements – move the fabric smoothly and at an even pace

Poor stitch formation

- if the thread forms loops, the work is being moved too quickly
- if knots are forming on the underside, the work is being moved too slowly

Monofilament hints

- if the monofilament thread breaks, sew more slowly and/or reduce the upper thread tension slightly

Using decorative stitches with functions

Stitch: **Any decorative stitch**
 Needle: **size and type suitable for the fabric selected**
 Thread: **cotton or rayon embroidery**
 Feed-dog: **up (sewing position)**
 Presser foot: **Reverse pattern foot No. 1 or
 Embroidery foot No. 6 or
 Open embroidery foot No. 20 (optional accessory)**

Combining basic settings and functions

· you can achieve some exciting effects by combining basic settings with various functions

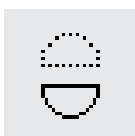
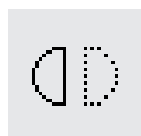

Horizontal mirror image
Vertical mirror image

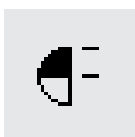

Pattern end 1-9x
Half pattern



Balance
Long stitch function

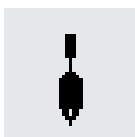
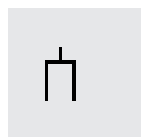

Double needle limitation 2-5 mm
Wing needle limitation

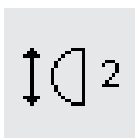
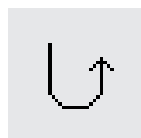

Continuous reverse sewing
Pattern extend 2-5x

Balance

- use balance to obtain variations on stitches
- the stitch will be stretched open or compressed, depending on the number of balance steps
- for additional information on the balance function, see page 44

Method

- select stitch
- select function
- several functions can be activated for one stitch

Deleting functions

- press the external clr button
- delete special functions individually by touching the appropriate symbol

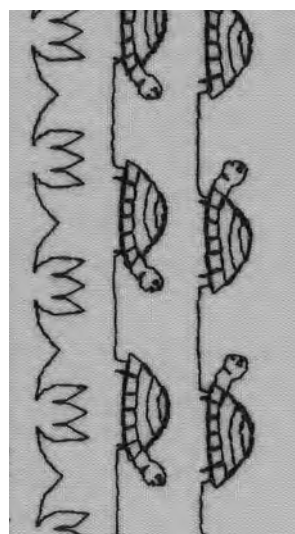
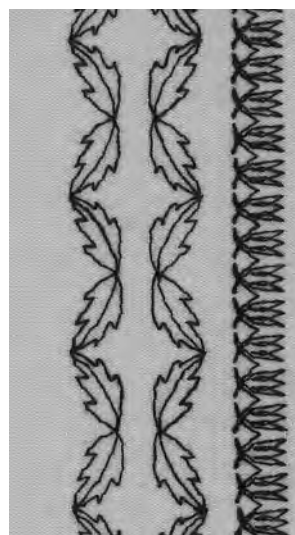

TIPS

Variations with basic settings and functions

- before starting a new combination, clear all functions previously used

Decorative stitches on single layer fabric

- always use stabilizer
- remove stabilizer after sewing

Activate needle stop down when sewing long rows of stitches

- needle stays in fabric when stopping to reposition work

Single Pattern

- the machine stops automatically at the end of each individual stitch pattern

Practical and decorative stitches in memory

- the memory capacity is 1023 individual stitch patterns
- the memory has 255 banks
- each bank can be sub-divided as desired
- most practical and decorative stitches as well as letters and numbers can be combined, programmed, and saved in memory
- exceptions: buttonholes
- all saved stitches remain in the memory when the machine is turned off
- all saved stitches and combinations can be recalled at any time

Programming practical and decorative stitches

- open the memory by pressing the external mem button
- touch mem 1 to access the memory storage screen
- select an empty memory bank
- touch OK to return to the previous screen
- select the desired stitch
- the stitch appears in the mem field
- select the next desired stitch
- continue in this manner until the desired combination of stitches has been programmed
- to save, touch store

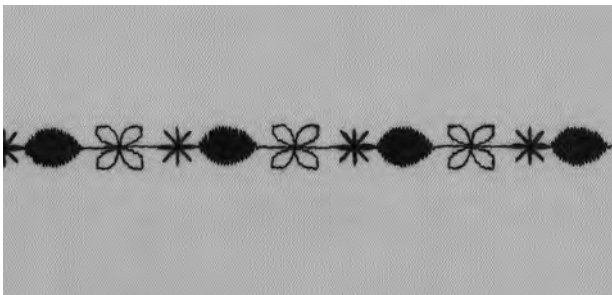

Example of programmed stitch combination

- select a memory bank following the directions above
- touch stitch 407 one time
- touch stitch 102 one time
- touch stitch 711 one time
- begin stitching; the stitches will continuously alternate
- to save, touch store

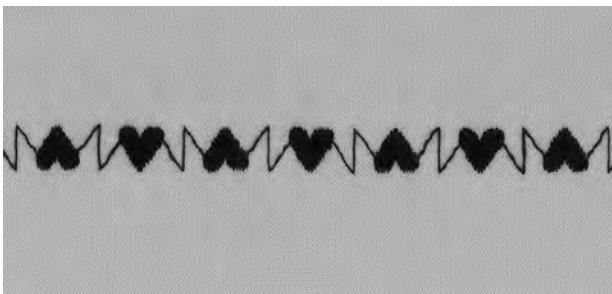

Examples of programmed stitch with function

- select a memory bank following the directions above
- touch stitch 413 one time
- activate vertical mirror image
- touch stitch 413 one time
- begin stitching; the stitches will continuously alternate facing up and down
- to save, touch store

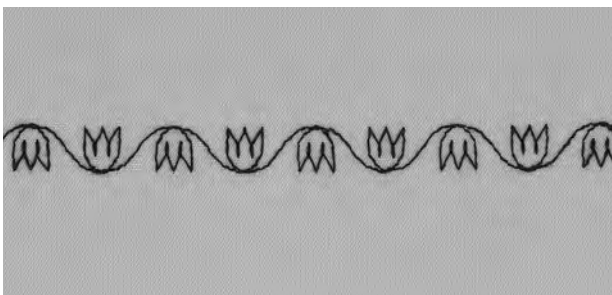

- select a memory bank following the directions above
- touch stitch 104 one time
- activate vertical mirror image
- touch stitch 104 one time
- begin stitching; the stitches will continuously alternate facing up and down
- to save, touch store

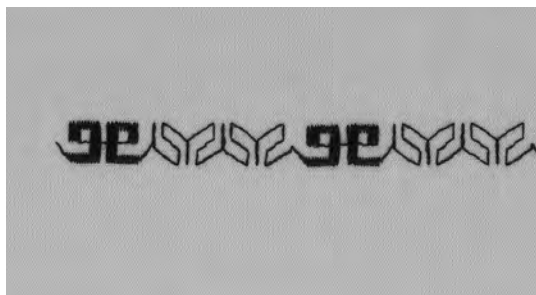
**Stitch combination as single repeat**

- select a memory bank following the directions on the previous page
- touch stitch 409 one time
- touch stitch 616 two times
- on the toolbar, activate Pattern end 2
- stitch; the machine stops automatically at the end of the second combination of stitches
- to save, touch store

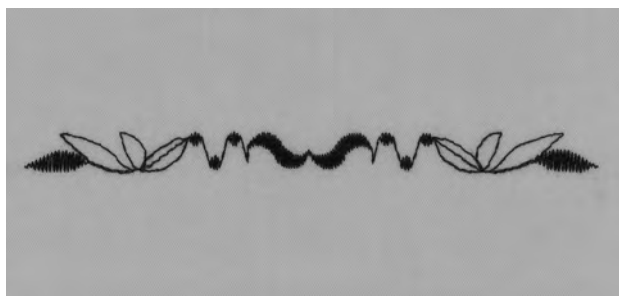
**Stitch combination with mirror image as single repeat**

- select a memory bank following the directions on the previous page
- touch stitch 109 one time
- touch stitch 414 one time
- activate horizontal mirror image
- touch stitch 414 one time
- activate horizontal mirror image
- touch stitch 109 one time
- on the toolbar, activate Pattern end 1
- stitch; the machine stops automatically at the end of the combination of stitches
- to save, touch store

**TIPS****Decorative stitch combination with 30 wt-embroidery thread**

- stitches appear fuller

Stitch combinations on single layer of fabric

- always use a stabilizer
- remove stabilizer after sewing

Letters and numbers in memory

- the memory capacity is 1023 individual stitch patterns
- the memory has 255 banks
- each bank can be sub-divided as desired
- most practical and decorative stitches as well as letters and numbers can be combined, programmed, and saved in memory
- exceptions: buttonholes and eyelets
- all saved stitches remain in the memory when the machine is turned off
- all saved stitches and combinations can be recalled at any time

Programming letters and numbers

- open the memory by pressing the external mem button
- touch mem 1 to access the memory storage screen
- select an empty memory bank
- touch OK to return to the previous screen
- select the desired letter
- the letter appears in the mem field
- select the next desired letter
- continue in this manner until the desired combination of letters has been programmed
- to save, touch store

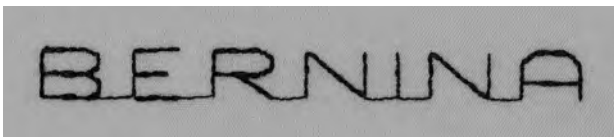
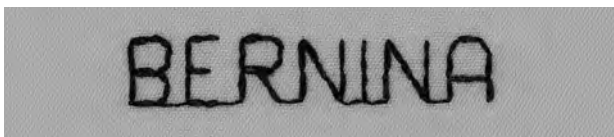

Examples of programming letters

- select a memory bank following the directions above
- press the external alphabet button
- touch the block letter alphabet
- touch the appropriate letters to spell "BERNINA"
- on the toolbar, activate Pattern end 1
- begin stitching; the letters will continuously stitch, automatically stopping after the "A"
- to save, touch store
- for double length letters, select Pattern the Extend 2x function before programming

Examples of programming numbers

- follow the directions above for programming letters, selecting numbers instead
- begin stitching; the numbers will continuously stitch, automatically stopping after the last one
- to save, touch store

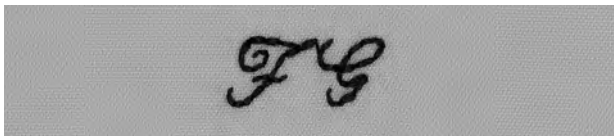

Examples of programming small monograms

- select a memory bank following the directions above
- press the external alphabet button
- touch the 5mm script alphabet
- touch the desired letters
- on the toolbar, activate Pattern end 1
- begin stitching; the letters will continuously stitch, automatically stopping after the last one
- to save, touch store

Securing

- select the Securing function
- the first and last letters will be secured



TIPS

Activate Pattern end after programming

- the machine will sew the program once and stop

Embroidering letters on a single layer of fabric

- always use stabilizer
- remove stabilizer after sewing

Balance

All stitches are tested and adjusted before the machine leaves the factory; however, shipping and transporting can affect the setting of the balance function.

Different fabrics, threads and stabilizers can distort the stitch patterns so that they are too long (do not close properly) or too short (have a condensed appearance).

The electronic balance function can be used to correct these distortions so that stitches can be adjusted for a perfect formation on the fabric of your choice.

Stitch: **all stitches**
 Needle: **all types, 70–110**
 Thread: **all threads**
 Feed-dog: **up (sewing position)**
 Presser foot: **as indicated on screen**

Test sewing

- it is always a good idea to test sew with the materials you intend to use – fabric, stabilizer and threads

Open balance

- touch the arrow on the functions toolbar
- scroll the functions
- touch “b”



Balance and practical stitches / decorative stitches

- soft fabrics such as jerseys and tricot have a tendency to stretch under the presser foot
- stitches such as Honeycomb may therefore not close correctly
- this can be corrected with the balance function

Balance for practical stitches

- the stitch as it should look, e.g. Honeycomb, is in the center of the screen
- possible stitch distortions are shown to the right and left of the correct stitch
- the arrows at the bottom of the screen show in which direction the stitch should be corrected

Note: the honeycomb stitch graphic will be seen on-screen for all practical stitches

Corrections

- touch the appropriate arrow to balance the stitch
- the number of steps is shown above the arrow
- 2–5 steps are normally sufficient to balance practical stitches (max. 50 steps)

Balance for decorative stitches

- the method is the same as for practical stitches
- Note: the satin stitched oval graphic will be seen on-screen for all decorative stitches

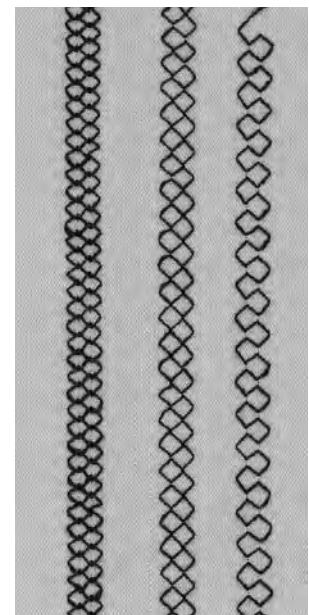

overlapping stitch balanced stitch open stitch

Index

A		H		S	
Auto buttonholes	25	Honeycomb stitch edges	12	Securing program (straight stitch)	3
Auto round and keyhole buttonholes	26			Sewing knits	12,13
Automatic darning program	33	J		Stitch counter buttonholes	27
B		L		T	
Balance practical/decorative stitches	44	Jersey overlock seam	9	Straight stitch buttonholes	24
Bar tack program	20			Straight stitch with securing program	3
Basting	16	Letters and numbers in memory	43	Straight stitch	2
Blind hem	17	Long Stitch	15	Stretch overlock seam	10
Button Sew-on program	29	M		Stretch/Super stretch seam	8
Buttonholes	21–28	Manual buttonholes	28	U	
C		Manual darning	34	V	
Contents	1	Memory – letters and numbers	43	Vari-overlock – ribbing	13
Cross stitches	36	Memory – practical and decorative stitches	41–43	Vari-overlock seam	9
D		N		Z	
Darning programs	33	Numbers and letters in memory	43	Zig-zag stitch	5
Darning, mending	31–34	P		Zippers	14
Decorative stitches in memory	41–43	Personal (altered) memory	6	Q	
Decorative stitches with functions	40	Practical stitch hems	11	Quilt stitches	38
Decorative stitches	35	Practical stitch seams	7–10	Quilt/hand look stitches	37
Double overlock seam	9	Practical stitches in memory	41–43	R	
E		N		S	
Edge stitching	4	Numbers and letters in memory	43	Reinforced darning program	33
Edges of knits with elastic	31	P		Reinforcing edges on woven fabrics	32
Elastic – sewing on	18, 19	Personal (altered) memory	6	Ribbing with overlock	13
Eyelets, straight stitch	30	Practical stitch hems	11	S	
Eyelets, zig-zag	30	Practical stitch seams	7–10	Securing program (straight stitch)	3
F		Practical stitches in memory	41–43	Sewing knits	12,13
Flat joining seam	10	Q		Stitch counter buttonholes	27
Freehand quilting	39	Quilt stitches	38	Straight stitch buttonholes	24
G		Quilt/hand look stitches	37	Straight stitch with securing program	3
Gathering stitch – sewing on elastic/cord	18	R		Straight stitch	2
		Reinforced darning program	33	Stretch overlock seam	10
		Reinforcing edges on woven fabrics	32	Stretch/Super stretch seam	8
		Ribbing with overlock	13	T	
				Triple straight stitch seam	8
				U	
				Universal stitch – sewing on elastic	18
				V	
				Vari-overlock – ribbing	13
				Vari-overlock seam	9
				Z	
				Zig-zag stitch	5
				Zippers	14

