



BERNINA 750 QE



made to create **BERNINA**

Dear BERNINA Customer



Congratulations! You have decided on BERNINA and therefore on a product which will delight you for years. For more than 100 years our family company has attached greatest importance to satisfied customers. As for me, it is a matter of personal concern to offer you Swiss development and precision at the height of perfection, future-orientated sewing technology and a comprehensive customer service.

The BERNINA 7-series consists of three ultramodern sewing-/embroidery computers, whose development not only focused the highest demands on technique and the ease of use but also considered the design of the product. After all we sell our products to creative people like you, who do not only appreciate high quality but also form and design.

Enjoy the creative sewing, quilting and embroidering on your new BERNINA 750 QE and keep informed about the various accessories at [www.bernina.com](http://www.bernina.com). On our homepage you will also find a lot of inspiring sewing instructions, to be downloaded for free.

Our highly trained BERNINA dealers will provide you with more information on service and maintenance offers.

I wish you lots of pleasure and many creative hours with your new BERNINA.

H.P. Ueltschi  
Owner  
BERNINA International AG  
CH-8266 Steckborn  
[www.bernina.com](http://www.bernina.com)

# SAFETY INSTRUCTIONS

## IMPORTANT INFORMATION

When using an electrical appliance, basic safety precautions should always be followed, including the following:

Read all the instructions before using this sewing-/embroidery computer.

**When the sewing-/embroidery computer is not in use, it should be disconnected from the electricity supply by removing the plug from the outlet.**

### DANGER!

To reduce the risk of electrical shock:

1. The sewing-/embroidery computer should never be left unattended when plugged in.
2. Always unplug this sewing-/embroidery computer from the electrical outlet immediately after using and before cleaning.
3. LED Radiation – Do not view directly with optical instruments. Class 1M LED product.

### WARNING!

To reduce the risk of burns, fire, electric shock or injury to persons:

1. Use this sewing-/embroidery computer only for purposes as described in this manual. Use only attachments, accessories and parts recommended by the manufacturer.
2. Do not allow this sewing-/embroidery computer to be used as a toy. Close attention is necessary when this sewing-/embroidery computer is used by or near children and infirm persons. The sewing-/embroidery computer is not intended for use by persons (including children) with reduced physical, sensory or mental capabilities or lack of experience and knowledge, unless they have been given supervision or instruction concerning use of the sewing-/embroidery computer by a person responsible for their safety. To ensure children do not play with

the sewing-/embroidery computer they must be supervised.

3. Never operate this sewing-/embroidery computer if:
  - it has a damaged cord or plug
  - it is not working properly
  - it has been dropped or damaged
  - it has fallen into water
 Return the sewing-/embroidery computer to your local authorized BERNINA dealer for examination or repair.
4. Never operate the sewing-/embroidery computer with any air openings blocked. Keep ventilation openings of the sewing-/embroidery computer free from the accumulation of lint, dust and loose cloth.
5. Keep fingers away from all moving parts. Special care is required around the sewing needle.
6. Never insert any objects into any openings on the sewing-/embroidery computer.
7. Do not use the sewing-/embroidery computer outdoors.
8. Do not operate the sewing-/embroidery computer where aerosol products (sprays) or oxygen are being used or where oxygen is being administered.
9. Do not pull or push the fabric while stitching. This may deflect the needle, causing it to break.
10. Do not use bent needles.
11. Always use the original BERNINA stitch plate. The wrong stitch plate can cause needle breakage.
12. To disconnect, turn power switch to «0» (off), then remove the plug from the outlet. Do not unplug by pulling the cord, instead grasp the plug to pull it from the outlet.
13. Turn power switch to «0» (off) when making any adjustments in the needle area, such as changing the needle or the presser foot, etc.
14. Always unplug the sewing-/embroidery computer from the electrical outlet when carrying out cleaning or maintenance work or any other user servicing adjustments mentioned in this manual.
15. This sewing-/embroidery computer is provided with double insulation (except USA and Canada). Use only identical replacement parts. See instructions for servicing of double-insulated products.

## SERVICING DOUBLE-INSULATED PRODUCTS

In a double-insulated product two systems of insulation are provided instead of grounding. No grounding means is provided on a double-insulated product, nor should a means for grounding be added to the product. Servicing a double-insulated product requires extreme care and knowledge of the system and should be done only by qualified service personnel. Replacement parts for a double-insulated product must be identical to the original parts in the product. A double-insulated product is marked with the words: «DOUBLE INSULATION» or «DOUBLE INSULATED».

The symbol  may also be marked on the product.

## DISCLAIMER

No liability will be assumed for any possible damage which arises from misuse of this sewing-/embroidery computer.

This sewing-/embroidery computer is intended for household use only.

This sewing-/embroidery computer meets the European Standard 2004/108/EC concerning the electromagnetic tolerance.

## SAVE THESE INSTRUCTIONS!



Please find the latest version of your instruction manual at [www.bernina.com](http://www.bernina.com)

### Environmental Protection



BERNINA is committed to the protection of the environment. We strive to minimize the environmental impact of our products by continuously improving product design and our technology of manufacturing.

When your sewing computer won't be used anymore, dispose this product in an environmentally responsible way according to the national directive. Do not throw away this product with your household waste. In case of doubt, please contact your BERNINA dealer.



If the sewing computer is stored in a cold room, it should be brought to a warm room about one hour before use.

## Contents Sewing

<b>Safety Instructions</b>	<b>2</b>	<b>Feed Dog lowered/ready to sew</b>	<b>28</b>
Environmental Protection	3	<b>Feed Dog and Fabric Feed</b>	<b>28</b>
<b>Key to Signs</b>	<b>8</b>	<b>Functions</b>	<b>30</b>
Glossary	8	<b>Overview «Function»-buttons sewing</b>	<b>30</b>
<b>Accessory</b>	<b>9</b>	• «Start/Stop»-button	30
Standard Accessories	9	• «Presser foot position»-button	30
Presser feet	10	• Automatic thread cutter	30
Accessory box free standing	11	• «Quick reverse»-button	30
Bobbin	11	• «Needle stop»-button	30
<b>Overview sewing computer</b>	<b>12</b>	• Programmable «Pattern end/Securing»-button	30
Front view	12	• Speed control	30
Detail view	12	• Stitch width and Stitch length Knobs (Multifunction)	31
<b>Important sewing information</b>	<b>14</b>	• «Needle position»-buttons	31
Thread	14	<b>Display</b>	<b>32</b>
Needle, thread and fabric	14	<b>Overview Main Display</b>	<b>32</b>
Needles, threads	15	• System settings	32
• Correct needle/Thread combination	15	• Menu Selection	32
• Too thin thread or too thick needle	15	• Selection	33
• Too thick thread or too fine needle	15	• Stitch Pattern selection	33
Overview needles	16	• Stitch Pattern Display	33
<b>Sewing preparation</b>	<b>18</b>	<b>Functions - Display</b>	<b>34</b>
Power Switch/Power Cable	18	<b>Overview Sewing functions</b>	<b>34</b>
Foot control	18	<b>General functions</b>	<b>34</b>
Slide-on table	18	<b>Overview Functions buttonholes</b>	<b>36</b>
Presser foot lifter	19	<b>Overview Functions Alphabets</b>	<b>38</b>
Vertical spool pin	19	<b>Overview Functions Combi mode</b>	<b>40</b>
Winding a bobbin	20	<b>Setup Program</b>	<b>44</b>
• Bobbin winding while sewing	20	<b>Overview «Setup»-display</b>	<b>44</b>
Inserting a bobbin/Threading lower thread	21	<b>Changing Display settings</b>	<b>45</b>
Removing/inserting bobbin case	21	• Brightness	45
• Removing the bobbin from the bobbin case	21	• Sewing light	45
Threading the upper thread	22	• Brightness sewing light	45
Changing the needle	22	• Welcome text	45
Threading the double needle	23	• Deleting Welcome text	45
Threading the triple needle	23	• Corrections	45
Thread needle	24	<b>Selecting the Display color</b>	<b>46</b>
Changing the presser foot	24	<b>Sewing settings</b>	<b>46</b>
Stitch plate	25	• Sewing speed	46
• Markings on the stitch plate	25	• Altering the upper thread tension	46
• Removing the stitch plate	25	• Securing stitches at pattern begin	46
• Replacing the stitch plate	25	• Automatic securing program at pattern end	47
Thread tension	26	• Automatic thread cutter	47
• Altering the upper thread tension	26	• Raising the presser foot	47
• Saving the upper thread tension	26	• Automatic thread cutter and securing stitches	47
• Reset settings	26	• Presser foot position when needle stop down	47
Altering presser foot pressure	27	• Presser foot in hover position	47
• When sewing thick material, e.g. quilting	27	• Reset settings	47
• Saving presser foot pressure	27	<b>Adjusting embroidery settings</b>	<b>48</b>
• Reset settings	27	• Calibrating the hoop	48
		<b>Display Calibration</b>	<b>49</b>
		<b>Altering the acoustic signals</b>	<b>49</b>
		<b>Monitoring</b>	<b>50</b>
		<b>Altering the winding speed</b>	<b>50</b>

<b>Update</b>	<b>51</b>	<b>Double overlock</b>	<b>74</b>
<b>Calibrating buttonhole foot No. 3A/Cleaning/ Packing position</b>	<b>51</b>	<b>Top stitching edges</b>	<b>75</b>
<b>Reset/Delete user data</b>	<b>52</b>	<b>Blind hem</b>	<b>76</b>
• Reset settings	52	<b>Visible hem</b>	<b>76</b>
• Delete user data	52	<b>Securing program</b>	<b>77</b>
<b>Information</b>	<b>53</b>	<b>Basting stitch</b>	<b>77</b>
• Language	53	<b>Flat joining seam</b>	<b>78</b>
• Version	53	<b>Height compensation of uneven layers</b>	<b>79</b>
• Dealer details	54	<b>Sewing corners</b>	<b>79</b>
• Service data	54		
<b>Tutorial</b>	<b>55</b>	<b>Buttonholes</b>	<b>80</b>
<b>Overview Tutorial</b>	<b>55</b>	<b>Overview Buttonholes</b>	<b>80</b>
<b>Creative consultant</b>	<b>57</b>	<b>Important information</b>	<b>81</b>
<b>Overview Creative consultant</b>	<b>57</b>	• Marking the length of manual buttonholes	81
<b>Overview Sewing techniques</b>	<b>57</b>	• Marking the length of automatic buttonholes	81
<b>Leaving the sewing consultant</b>	<b>57</b>	• Marking the length of keyhole buttonholes	81
<b>Help program</b>	<b>58</b>	• Test sewing	81
• Stitch patterns	58	• To adjust the bead width	81
• Functions	58	• To adjust stitch length	81
<b>Balance</b>	<b>59</b>	<b>Stabilizer</b>	<b>82</b>
<b>Practical and decorative stitches</b>	<b>59</b>	<b>Cords</b>	<b>83</b>
• Corrections	59	• Ideal cords	83
• Reset settings	59	• Cord with the automatic buttonhole foot No. 3A	83
<b>eco description</b>	<b>60</b>	• Cord with the buttonhole foot No. 3C (optional accessory)	83
• Activating eco	60	• Fixing the cord	83
• Deactivating eco	60	• Cutting buttonholes open with the seam ripper	83
<b>Practical stitches</b>	<b>62</b>	• Cutting open buttonholes with the buttonhole cutter (optional accessory)	83
<b>Overview Practical stitches</b>	<b>62</b>	<b>Altering the balance</b>	<b>84</b>
<b>Stitch pattern selection</b>	<b>64</b>	• Balance with direct entry length buttonholes	84
• Selecting stitch pattern	64	• Balance with direct entry length keyhole or round buttonholes	84
• By stitch number	64	• Balance for manual keyhole or round buttonhole	84
• Cancelling	64	• Balance for manual standard buttonhole	84
<b>Customizing stitch pattern individually</b>	<b>65</b>	• Balance for stitch counter buttonhole	84
<b>Temporary Altered Stitch Memory</b>	<b>65</b>	• Clear balance	84
<b>Personal memory permanent</b>	<b>66</b>	<b>Programming Buttonholes</b>	<b>85</b>
<b>Altering stitch width and stitch length</b>	<b>67</b>	<b>Standard and stretch buttonhole with auto-length,     automatically</b>	<b>85</b>
<b>Examples of application</b>		<b>Automatic with direct legth entry</b>	<b>86</b>
<b>Practical stitches</b>	<b>68</b>	<b>Automatic with button measuring</b>	<b>86</b>
<b>Straight stitch</b>	<b>68</b>	<b>Automatic round and keyhole buttonhole</b>	<b>87</b>
<b>Triple straight stitch</b>	<b>68</b>	<b>Decorative buttonhole with double     pointed bartack</b>	<b>88</b>
<b>Triple Zig-Zag</b>	<b>69</b>	<b>Heirloom Buttonhole</b>	<b>89</b>
<b>Zipper</b>	<b>70</b>	<b>Stitch counter buttonhole</b>	<b>89</b>
<b>Manual darning</b>	<b>71</b>	<b>Buttonhole in long term memory</b>	<b>90</b>
<b>Automatic darning</b>	<b>72</b>	<b>7- or 5-step-buttonhole, manually</b>	<b>92</b>
<b>Reinforced darning, automatic</b>	<b>73</b>	<b>Button sew-on program</b>	<b>93</b>
<b>Finishing edges</b>	<b>73</b>	<b>Eyelet program</b>	<b>94</b>

<b>Decorative stitches</b>	<b>95</b>	<b>Alphabet in combination with functions</b>	<b>111</b>
Overview Decorative stitches	95	• Select lower case	111
Application	95	• Change size	111
<b>Examples of application Decorative stitches</b>	<b>96</b>	<b>Personal program</b>	<b>112</b>
Cross Stitches	96	<b>Creating a Personal Display</b>	<b>112</b>
Pintucks	97	<b>Preparing stitch patterns</b>	<b>112</b>
Bobbin-Play sewing	98	• Programming/Saving first stitch pattern	112
<b>Quilt stitches</b>	<b>99</b>	• Programming/Saving second stitch pattern	113
Overview Quilt stitches	99	• Stitch pattern selection in the Personal program	113
<b>Examples of application Quilt stitches</b>	<b>100</b>	• «Personal»-display	113
Handlook quilt stitch	100	<b>Altering/Overwriting stitch patterns</b>	<b>114</b>
For free-motion quilting	101	<b>Deleting stitch patterns</b>	<b>115</b>
<b>BSR (BERNINA Stitch Regulator)</b>	<b>102</b>	<b>Combi mode</b>	<b>116</b>
<b>Quilting with BSR</b>	<b>102</b>	<b>Creating stitch combinations</b>	<b>116</b>
• BSR-Function	102	• Programming and saving	116
• BSR function with straight stitch No. 1	102	<b>Deleting Stitch Patterns</b>	<b>117</b>
• BSR function with zig-zag No. 2	102	<b>Opening a saved combination</b>	<b>117</b>
• Two different BSR modes	102	<b>Correcting a stitch pattern combination</b>	<b>118</b>
• Preparation	103	• Inserting a stitch pattern	118
• Remove presser foot sole	103	• Altering stitch patterns	118
• Attaching the presser foot sole	103	• Mirroring complete combinations	119
<b>Functions in the BSR mode</b>	<b>104</b>	• Combination subdivider 1	119
• Needle stop down (standard)	104	• Interrupting a combination	119
• Needle stop up	104	<b>Stitch pattern combination</b>	<b>120</b>
• Raise or lower the needle	104	• Overwriting	120
• Securing with the «Start/Stop»-button (only Mode 1)	104	• Deleting	120
• Securing function (only Mode 2)	104	<b>Contents Embroidery</b>	<b>121</b>
• Free motion quilting (only Mode 2)	104	<b>Cleaning</b>	<b>164</b>
• Free motion quilting without BSR activation	104	<b>Troubleshooting</b>	<b>166</b>
• Beeper (audio signal) activation/deactivation	105	<b>Stitch patterns</b>	<b>171</b>
• Selecting sound for BSR in the Setup Program	105	<b>Index</b>	<b>186</b>
• Selecting sound for BSR in the «BSR»-display	105		
• Activating the BSR Sewing Function	106		
• Deactivating the BSR Sewing Function by using the «Start/Stop»-button	106		
• BSR Function deactivation	106		
<b>BERNINA Dual Feed</b>	<b>107</b>		
• Presser Feet Selection	107		
• Switching On BERNINA Dual Feed	107		
• Switching Off BERNINA Dual Feed	107		
<b>Fabrics</b>	<b>108</b>		
<b>Alphabets</b>	<b>109</b>		
<b>Overview Alphabet</b>	<b>109</b>		
• Lettering	109		
• Perfect stitch formation	109		
<b>Combining lettering</b>	<b>110</b>		
<b>Correcting the combination</b>	<b>110</b>		





## Key to Signs



**DANGER!**  
Very important!  
Risk of injury!

**ATTENTION!**  
Very important!  
Risk of damage!



Tips!

## Glossary

<b>BERNINA USB stick</b>	Mobile storage medium
<b>Balance</b>	Correcting abnormalities in stitch formation due to the fabric
<b>Fabric fold</b>	Folded edge of material
<b>BSR</b>	BERNINA-Stitch-Regulator. Quilting with consistent stitch length within a certain speed
<b>clr</b>	Clear. Deleting settings or data
<b>Hook</b>	«Catches» the needle-thread loop, forming the stitch together with the lower thread
<b>LMS</b>	Length Measuring System for buttonhole
<b>Memory</b>	Long Term Memory
<b>Satin stitching</b>	Dense Zig-zag
<b>Bartack</b>	Buttonhole-bead cross-connections

### All rights reserved

For technical and product improvement reasons, the sewing computer's features, parts and accessory are subject to unannounced changes and alterations at any time. The included accessories can differ from country to country.

## Accessory

### Standard Accessories



- 1 Presser foot lifter
- 2 Foot control
- 3 Soft Cover With Pocket
- 4 Accessory Box
- 5 Power cable
- 6 Slide-on table

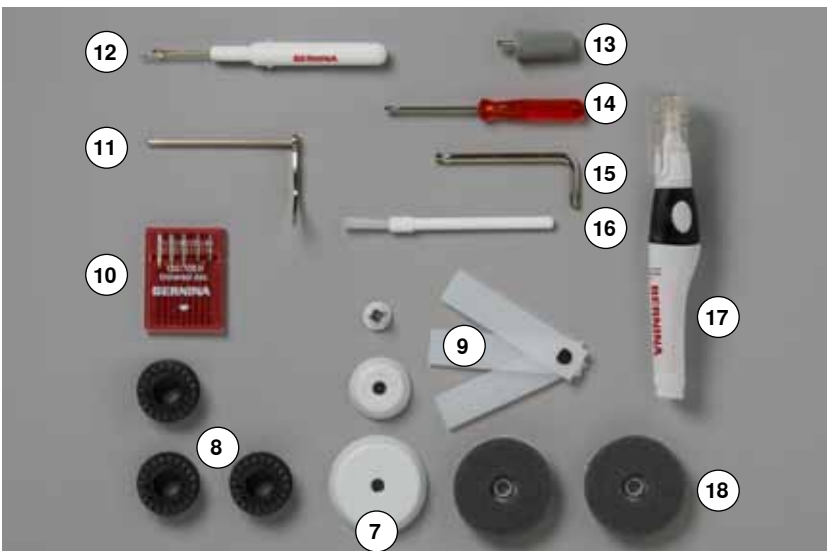

- 7 3 spool discs
- 8 4 bobbins (one of them in the bobbin case)
- 9 Height compensation tool
- 10 Selection of needles
- 11 Seam guide, right
- 12 Seam ripper
- 13 Screwdriver Torx, gray
- 14 Screwdriver, red
- 15 Angular Torx button
- 16 Lint brush
- 17 Lubricator
- 18 2 foam pads

## Presser feet



- 1 No. 1C Reverse pattern foot
- 2 No. 1D Reverse pattern foot
- 3 No. 3A Automatic buttonhole foot with slide
- 4 No. 4D Zipper foot
- 5 No. 5 Blindstitch foot
- 6 No. 20C Open embroidery foot
- 7 No. 37D Patchwork foot
- 8 No. 42 BSR foot



Visit [www.bernina.com](http://www.bernina.com) for more accessory information.

## Accessory box free standing



- on the back of the box, pull both extensions out until they click into place



### Lay-out

The box is equipped as standard with one large **1** and one small **2** drawer as well as a compartment for bobbin holders **5** and presser feet **7**.

- to remove a bobbin, press the compartment holder **6** lightly
- buttonhole foot with slide no. 3A can be stored in the left compartment **4**
- store the needle package in the special compartment **3**

Storage example

## Bobbin



### ATTENTION!

Treat the bobbins with care. Keep the white sensor surfaces free of scratches or stains to ensure correct.

### ATTENTION!

Put the bobbins into the appropriate case of the accessory box so that the silvery sensor surfaces are on the right side. Otherwise the bobbin can get jammed in the case, as the two bobbin surfaces are different in diameter.

## Overview sewing computer

### Front view



### Detail view

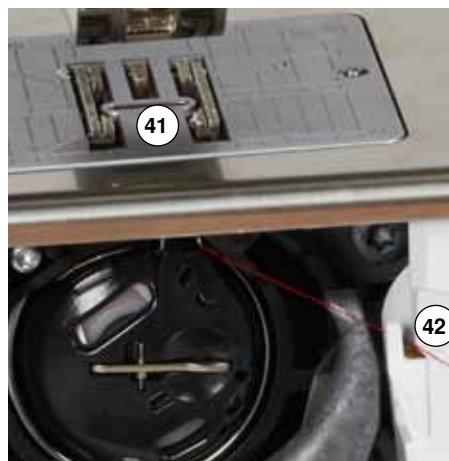
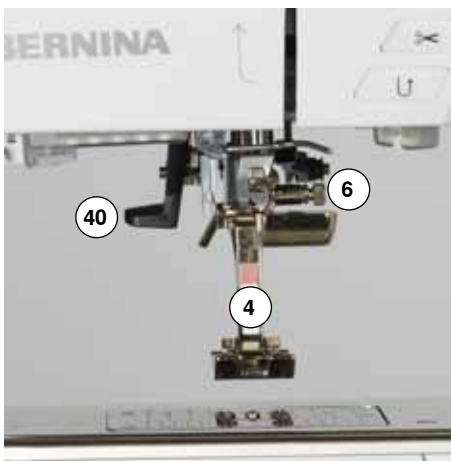



- |  |   |
|--|---|
| 1 Bobbin cover                                 | 27 Carrying handle  |
| 2 Stitch plate                                 | 28 Horizontal spool pin                                     |
| 3 Attachment base for special accessories      | 29 Vertical spool pin                                       |
| 4 Presser foot                                 | 30 Eyelet thread guide                                      |
| 5 LED-sewing light                             | 31 Handwheel  |
| 6 Needle clamp                                 | 32 Power switch On «I»/<br>Off «0»                          |
| 7 «Quick reverse»-button                       | 33 Power plug socket  |
| 8 «Automatic thread cutter»-button             | 34 Magnetic holder for touchscreen pen (optional accessory) |
| 9 «Presser foot up/down»-button                | 35 USB-connection   |
| 10 «Start/stop»-button                         | 36 PC-connection for embroidery software                    |
| 11 Thread guide                                | 37 Foot control socket                                      |
| 12 Slide Speed Control                         | 38 Feed dog drop  |
| 13 Thread take-up cover                        | 39 Air vents  |
| 14 «Needle stop»-button down/up                | 40 Needle threader  |
| 15 Programmable «Pattern end-/securing»-button | 41 Feed dog   |
| 16 Thread take-up lever                        | 42 Cutter for lower thread                                  |
| 17 Pre-tension stud                            | 43 Headframe fixing screw                                   |
| 18 Display                                     | 44 Thread cutter on the head frame                          |
| 19 «Sewing support»-buttons                    | 45 Slide-on table socket                                    |
| • «Home»-button                                | 46 Darning hoop connection                                  |
| • «Setup»-button                               | 47 Special-accessories port                                 |
| • «Tutorial»-button                            | 48 BSR-connection   |
| • «Creative Consultant»-button                 | 49 BERNINA Dual Feed  |
| • «Help»-button                                |   |
| • «eco»-button                                 |   |
| • «clr»-button                                 |   |
| 20 «Needle position»-buttons                   |   |
| 21 Stitch length knob                          |   |
| 22 Stitch width knob                           |   |
| 23 Bobbin winder                               |   |
| 24 Thread cutter on bobbin winder              |   |
| 25 Free hand system connection                 |   |
| 26 Rear thread guide                           |   |



**USA/Canada only:** The sewing computer has a polarized plug (one blade wider than the other). To reduce the risk of electrical shock, this plug is intended to fit in a polarized outlet only one way. If the plug does not fit fully in the outlet, reverse the plug. If it still does not fit, contact a qualified electrician to install the proper outlet. Do not modify the plug in any way!

## Important sewing information

### Thread

Be sure to select the appropriate thread type and weight for the fabric. For a perfect sewing result, thread and fabric quality play an important role. It is recommended to use quality brands.

#### Cotton threads

- cotton threads have the advantage of being a natural fiber and therefore are especially suitable for sewing cotton fabrics
- if cotton thread is mercerized, it has a slight sheen that is not lost with washing

#### Polyester threads

- polyester thread has a high tensile strength and is particularly colorfast
- polyester threads are more flexible and are recommended where a strong and elastic seam is required

#### Rayon threads

- rayon threads are made of natural fibers and have a brilliant sheen
- rayon threads are suitable for decorative stitches and achieve a more beautiful effect

### Needle, thread and fabric

#### **ATTENTION!**

**Check the needle condition.**

**As a guide: Replace the needle before starting a new sewing project. A defective needle does not only damage the sewing project but also the sewing computer.**

Care must be taken when choosing needle and thread.

The correct needle size depends on the selected thread and fabric. The fabric weight and type determine the thread weight, needle size and point form.

## Needles, threads

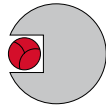

### Correct needle/Thread combination

When sewing, the thread should travel smoothly down the long groove on the front of the needle.

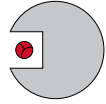

### Too thin thread or too thick needle

The thread has too much clearance in the long groove. Skipped stitches and damage to the thread can occur.

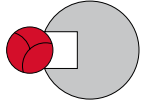

### Too thick thread or too fine needle

The thread rubs on the edges of the long groove and can get jammed. This can cause thread breakage.



### Guidelines

Material and thread	Needle size
Light weight materials: Fine thread (darning thread, embroidery thread)	70-75
Medium weight materials: Sewing thread	80-90
Heavy weight materials: Sewing thread (quilting thread, topstitching)	100, 110, 120



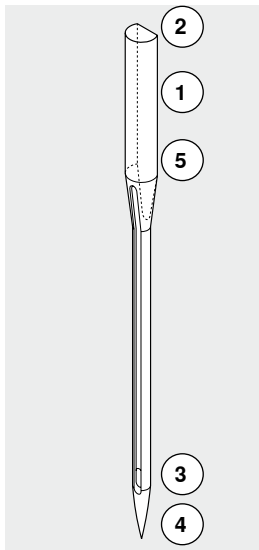





### 130/705 H-S/70

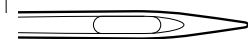

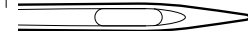
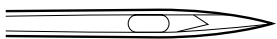
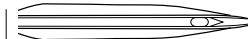
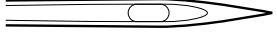
- 1 **130** Shank length
- 2 **705** Flat shank
- 3 **H** Needle scarf
- 4 **S** Needle point (here e.g. medium ball point)
- 5 **70** Needle size (shank diameter)



## Overview needles

<p><b>Universal</b> 130/705 H/60-100</p>  <p>Normal point, slightly rounded</p> <p>For nearly all natural and synthetic fabrics (woven and knitted)</p>	<p><b>Metafil</b> 130/705 H-MET/75-80 or H-SUK/90-100</p>  <p>Large eye</p> <p>Sewing with metallic threads</p>
<p><b>Jersey/Stretch</b> 130/705 H-S, H-SES, H-SUK/70-90</p>  <p>Ball point</p> <p>Jersey, knit and stretch material</p>	<p><b>Cordonnet (Topstitching)</b> 130/705 H-N/80-100</p>  <p>Small ball point, long eye</p> <p>Topstitching with thick thread</p>
<p><b>Leather</b> 130/705 H-LL, H-LR/90-100</p>  <p>With cutting point</p> <p>All types of leather, synthetic leather, plastic, sheeting</p>	<p><b>Wing needle (Hemstitch needle)</b> 130/705 HO/100-120</p>  <p>Wide needle (wing)</p> <p>Hemstitching</p>
<p><b>Jeans</b> 130/705 H-J/80-110</p>  <p>Very fine sharp point</p> <p>Heavy weight fabrics such as jeans, canvas, overalls</p>	<p><b>Double wing needle</b> 130/705 H-ZWI-HO/100</p>  <p>For special effects with hemstitch embroidery</p>
<p><b>Microtex</b> 130/705 H-M/60-90</p>  <p>Especially fine sharp point</p> <p>Micro fiber fabrics and silk</p>	<p><b>Double needle</b> 130/705 H-ZWI/70-100</p>  <p>Needle distance: 1.0/1.6/2.0/2.5/3.0/4.0/6.0/8.0</p> <p>Visible hems in stretch fabrics, pintucks, decorative sewing</p>
<p><b>Quilting</b> 130/705 H-Q/75-90</p>  <p>Fine sharp point</p> <p>Straight and topstitching</p>	<p><b>Triple needle</b> 130/705 H-DRI/80</p>  <p>Needle distance: 3.0</p> <p>Visible hems in stretch fabrics; Decorative sewing</p>
<p><b>Embroidery</b> 130/705 H-SUK/70-90</p>  <p>Large eye, slight ball point</p> <p>Embroidery on all natural and synthetic fabrics</p>	



## Sewing preparation

### Power Switch/Power Cable

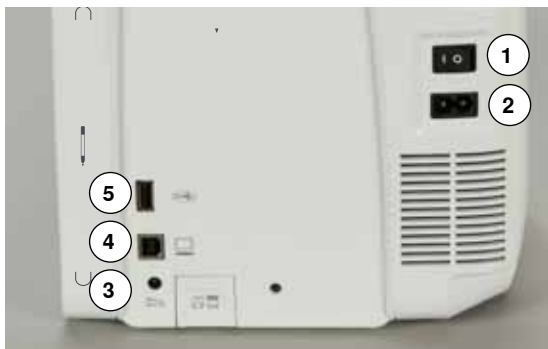

**1 Power Switch**  
The sewing computer is switched on («I») and off («0») with the power switch.

I the sewing computer is switched on  
0 the sewing computer is switched off

- 2** Power plug socket
- 3** Foot control socket
- 4** PC-connection for embroidery software
- 5** USB-connection

### Foot control



#### Connecting the foot control

- unwind the cable
- plug the cable in the outlet **1**
- unwind the cable to the desired length and slip into **4** or **5**

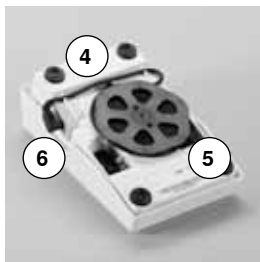
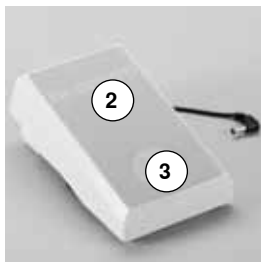

#### Sewing speed control

Control the sewing speed by pressing the foot control **2** more or less.

#### Adjust needle down or up

- sink the heel back **3** on the foot control
- ▶ the needle adjusts the position up/down

#### Removing the foot control

- wind the cable around the reel
- plug cable into **6**



**USA/Canada only: Use only foot controller type LV-1 with sewing computer B 750 QE.**

### Slide-on table

The slide-on table increases sewing surface.

#### Attaching the slide-on table

- turn the handwheel (see page 13)
- ▶ needle is raised
- press «Presser foot up/down»-button
- ▶ presser foot is lifted
- slide table to the right, over the free arm until it engages



#### Removing the slide-on table

- raise the needle and presser foot
- press button **1** down
- pull slide-on table to the left

## Presser foot lifter

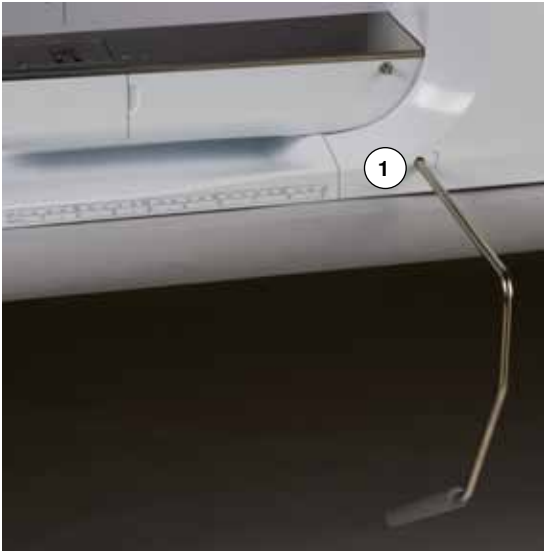

Raising or lowering presser foot via FHS.

### Attaching the Free Hand System

- insert into the opening **1**

### Raising and lowering the presser foot

- with your knee push lever to the right
- you should be able to operate the FHS with your knee in your normal sitting position
- ▶ the presser foot is raised; the feed dog is lowered simultaneously. The thread tension is released
- ▶ the feed dog is raised as soon as the first stitch is sewn



Your dealer can adjust the FHS if necessary.

## Vertical spool pin



The vertical spool pin is on the side behind the handwheel.

It is an essential aid for sewing with more than one thread, e.g. double needle work and can also be used for winding the bobbin while sewing.

- turn the spool pin **1** as far it will go



- use foam pad **2** for stability with all thread spools

## Winding a bobbin



- turn power switch to «I» (on)
- place empty bobbin on spindle **1**

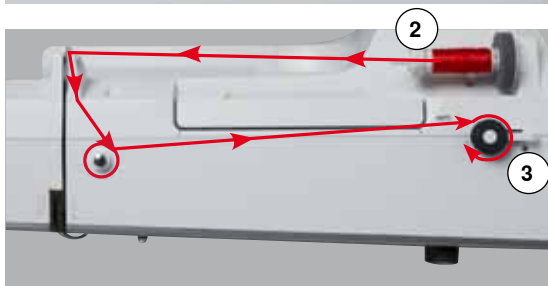

- place foam pad on the spool pin
- place thread on the spool pin
- attach appropriate spool disc **2**
- following the direction of the arrow, take the thread through the rear guide and around the pre-tension stud
- wind the thread two to three times around the empty bobbin
- cut off any excess thread on the thread cutter **3**



### Appropriate spool disc

Diameter of thread spool determines disc size. There must be no gap between the disc and the spool.

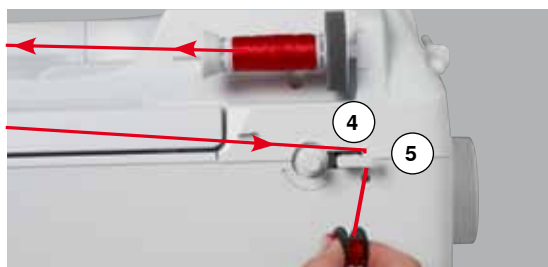

- push engaging lever **4** towards bobbin
- ▶ the winder works automatically
- ▶ the Display to wind the bobbin appears
- move the round knob in the Display using the finger to the left/right or
- turn the stitch width knob (see page **12**)
- ▶ the winding speed is altered
- ▶ the motor will stop automatically when the bobbin is full
- ▶ the Display is closed
- remove bobbin and pull the thread over thread cutter **5** to cut it

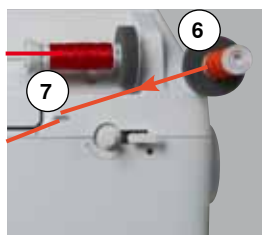

### Bobbin winding while sewing

- attach foam pad on the vertical spool pin **6**
- place thread on the vertical spool pin
- following the direction of the arrow, take the thread through the thread guide **7** and

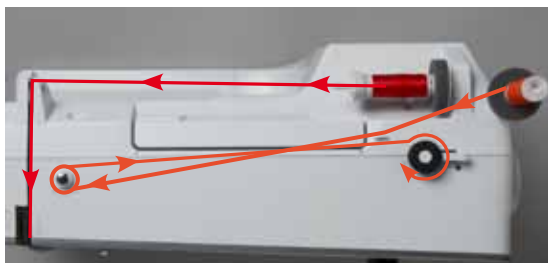

- guide around the pre-tension stud

Then proceed as mentioned above.



It is recommended to reduce the winding speed when winding from the vertical spool pin.

## Inserting a bobbin/Threading lower thread

### Removing the bobbin from the bobbin case

- press the release lever at the bobbin case (see illustration «Changing bobbin case» on this page)



- remove the bobbin case according to following description
- insert the bobbin so that the thread is wound counterclockwise 1
- pull the thread from the left into the slot



- pull the thread to the right under the spring 2
- lead the thread beneath the thread guide and pull upwards
- ▶ the thread is threaded in the guide
- pull the thread
- ▶ the bobbin must turn counterclockwise

## Removing/inserting bobbin case

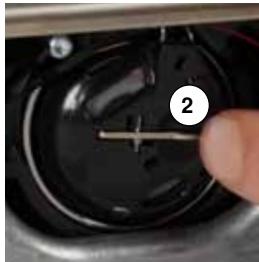

### Removing the bobbin case

- raise the needle
- turn power switch to «0» (off)
- open bobbin cover 1

- press bobbin case release 2
- remove the bobbin case



### Inserting the bobbin case

- hold the bobbin case with the thread guide 3 pointing upwards
- put the thread guide into the notch 4 of the hook race cover
- insert the bobbin case and press in the center until it clicks into place

### Bobbin thread cutter

- pull the thread over thread cutter 5 to cut it
- close the cover



## Threading the upper thread

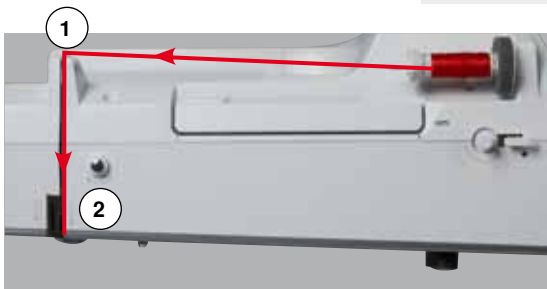
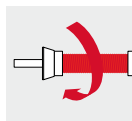

- raise the needle and presser foot
- turn power switch to «0» (off)
- place foam pad on the spool pin
- place spool on pin so that the thread unwinds clockwise
- attach appropriate spool disc

- hold the thread and lead it from the spool along the direction of the arrow into the rear guide **1**
- then into slit of upper thread tension **2**

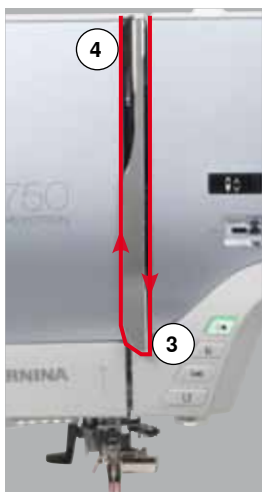

- pull thread down to the right of the take-up cover and around **3**
- take thread up to the left of the cover and around **4**, placing it in the take-up lever
- take thread down and through guides **5** and **6**
- thread the needle (see page **24**)

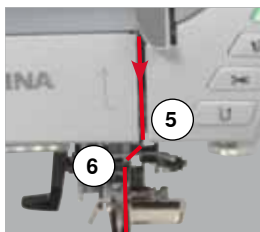

### Appropriate spool disc

Diameter of thread spool determines disc size. There must be no gap between the disc and the spool.

## Changing the needle

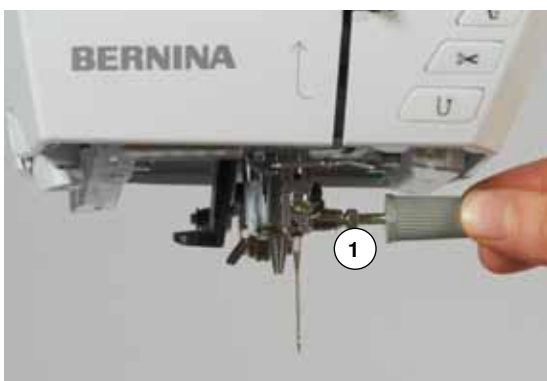

### Removing the needle

- raise the needle
- remove or lower presser foot (see page **24, 30**)
- turn power switch to «0» (off)
- loosen the needle clamp screw **1** using the gray screwdriver
- pull the needle down to remove

### Inserting the needle

- flat side of needle to the back
- insert the needle as far as it will go
- tighten needle clamp **1** using the gray screwdriver

## Threading the double needle

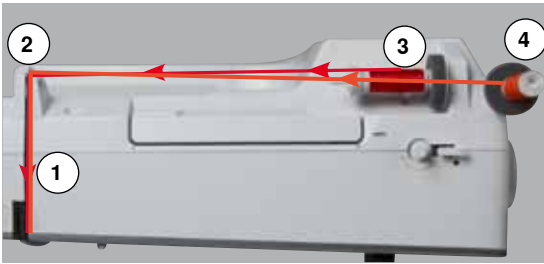

### Threading the first thread

- raise the needle and the presser foot, remove the presser foot if necessary
- turn power switch to «0» (off)
- insert double needle
- place foam pad on the spool pin
- place thread spool **3** on horizontal spool pin
- attach appropriate spool disc
- take thread through rear guide **2**
- guide the thread to the front in the slit and past the tension disc **1** on the **right** side
- guide the thread to the needle as usual and
- thread the **right** needle manually

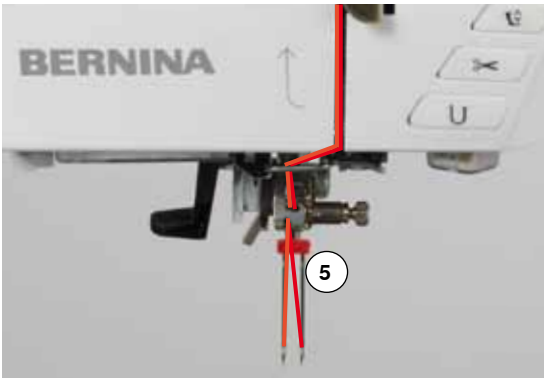

### Threading the second thread

- place foam pad on vertical spool pin
  - place the second thread spool **4** on the vertical spool pin
  - take thread through rear guide **2**
  - guide the thread to the front in the slit and past the tension disc **1** on the **left** side
  - guide the thread to the needle as usual and
  - thread the **left** needle manually
- Threads **5** must not be twisted together.



When using the vertical spool pin, always add a foam pad. This prevents the thread from twisting around the spool pin.

## Threading the triple needle

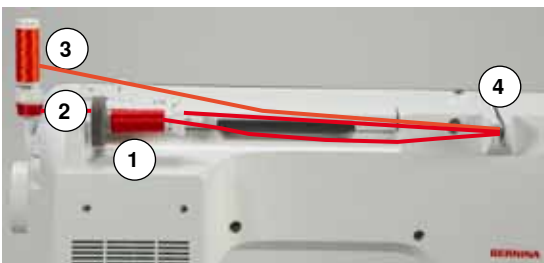

Two thread spools and one full bobbin are needed.

- insert triple needle
- place one thread spool **1** on horizontal spool pin
- place second thread spool **3** and the bobbin **2**, separated by a spool disc, on vertical spool pin (both spools must to turn in the same direction)
- thread as usual and
- guide **two** threads on the **left** side of the tension disc **4** and **one** thread past the **right** side
- guide threads to the needle as usual
- and thread every needle manually



By using the Guide eyelet for metallic and silk thread (optional accessory) the thread release from the stacked spool/bobbin can be enhanced.



## Thread needle

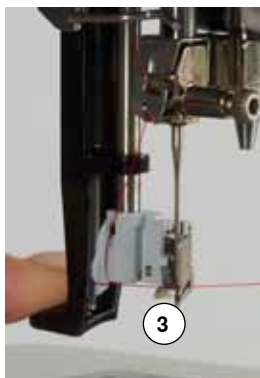
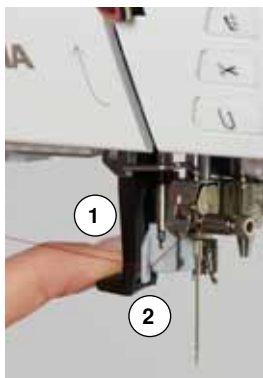

Position the needle by pressing the foot control once (1 stitch).

- raise the needle
  - lower the presser foot
  - turn power switch to «0» (off)
  - hold thread to the left and back
  - press lever 1 down and hold it
  - guide thread around the hook 2 to the right in front of the needle
  - put the thread from the front into the guide 3 until it catches in the wire hook
  - release lever 1 and thread
  - ▶ needle is threaded
  - pull the thread to the back and
  - put the thread under the foot and pull it from back to front over the thread cutter on left side of the head frame 4, cut
- Threads release automatically as soon as the first stitch is sewn.

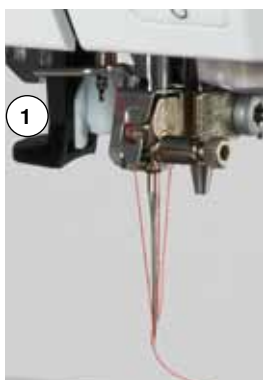

## Changing the presser foot



### Removing the presser foot

- raise the needle and presser foot
- turn power switch to «0» (off)
- raise the clamping lever 1
- remove the presser foot



### Attaching the presser foot

- guide the presser foot upwards over the cone
- press the clamping lever 1 down

## Stitch plate

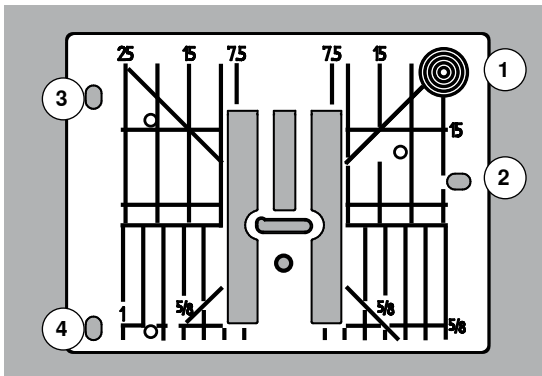

### Markings on the stitch plate

- the stitch plate is marked with vertical, horizontal and diagonal lines in **mm** and **inches**
- the lines help to guide the fabric for sewing seams and precise topstitching, etc.
- the horizontal markings are helpful for sewing corners and buttonholes, etc.
- the diagonal markings are useful for quilting
- needle insertion point is position «0» (center needle position)
- the vertical measurements correspond to the distance between the needle and the line
- measurements are marked to the right and to the left of center needle position



### Removing the stitch plate

- press «Feed dog»-button 5
- ▶ the feed dog is lowered
- turn power switch to «0» (off)
- remove presser foot and needle
- press the stitch plate down at the right back corner 1 until it flips up
- remove the stitch plate

### Replacing the stitch plate

- place the openings of the stitch plate 2, 3 and 4 above the corresponding guide pins
- press down until it clicks into place
- press «Feed dog»-button
- ▶ the feed dog is raised as soon as the first stitch is sewn

## Thread tension



Higher upper thread tension = the upper thread is tightened, which pulls the lower thread up to the top of the fabric.  
Lower upper thread tension = the upper thread is loosened, which enables it to be pulled to the back of the fabric.

Basic settings are applied automatically when a stitch pattern or program is selected.

**The upper thread tension is set optimally at the BERNINA factory and the sewing computer has been tested. Metrosene-/Seralon thread size 100/2 (Company Mettler, Switzerland) is used for upper and lower thread.**

In case of using other types of sewing or embroidery threads, the optimal tension may vary. Therefore it may be necessary to adjust the upper thread tension according to the fabric and the desired stitch pattern.



### Altering the upper thread tension

- touch «i»-icon
- touch «Upper thread tension»-icon

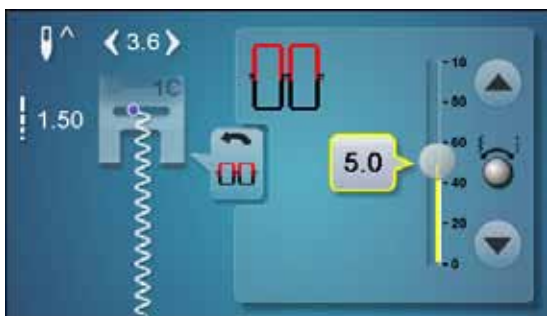

- ▶ the optimal stitch formation (stitch formation in the fabric) is visible
- ▶ the white bar within the scale and the number in the icon show the basic setting
- touch arrow icon up/down or
- turn stitch width or stitch length knob to the left or to the right or
- move the round knob in the Display using the finger
- ▶ upper thread tension is tightened or loosened
- ▶ the alteration of the upper thread tension is visible within the scale (yellow) and in the yellow-framed icon
- ▶ basic setting remains visible (white)
- ▶ the alteration of the upper thread tension only affects the selected stitch



### Saving the upper thread tension

- touch «Back»-icon
- ▶ the setting is saved and the Display closes

### Reset settings

- touch the yellow-framed icon
- ▶ basic setting is reset
- switch off the sewing computer
- ▶ any alterations are deleted

## Altering presser foot pressure



- touch «i»-icon
- touch «presser foot pressure»-icon

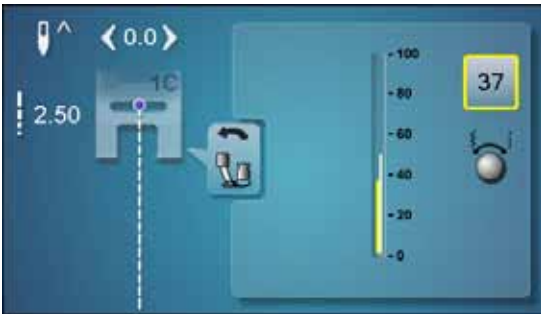

- ▶ presser foot pressure scale is displayed
- turn stitch width or stitch length knob to the left or to the right
- ▶ presser foot pressure is increased or decreased
- ▶ alterations of the presser foot pressure is displayed in the scale (yellow) and in the yellow-framed icon
- ▶ the basic setting remains visible (white)

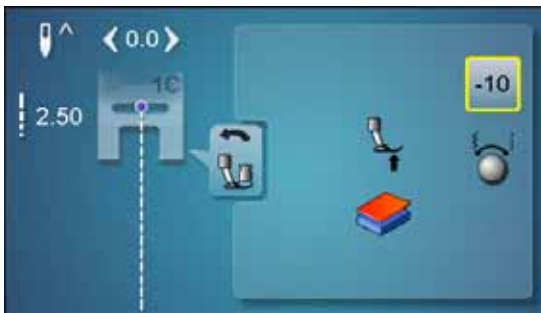

### When sewing thick material, e.g. quilting

- turn stitch width or stitch length knob to the left
  - ▶ the presser foot pressure decreases to minus
- The presser foot is slightly lifted and the material can be moved more simply.



### Saving presser foot pressure

- touch «Back»-icon
- ▶ the settings are saved and the display closes

### Reset settings

- touch the yellow-framed icon
- ▶ basic setting is reset



Reset the presser foot pressure to basic setting after finishing the task.

## Feed Dog and Fabric Feed

With each stitch the feed dog moves forward by one step. The length of this step is determined by the stitch length selected.

With an extremely short stitch length, the steps are also very short. The fabric moves away from the foot quite slowly, even at full sewing speed. e.g. buttonholes, satin stitch and decorative stitches are all sewn with a very short stitch length.

Let the fabric feed evenly.

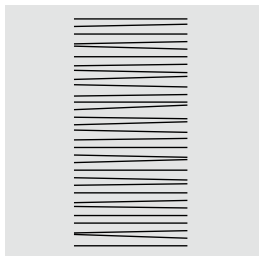
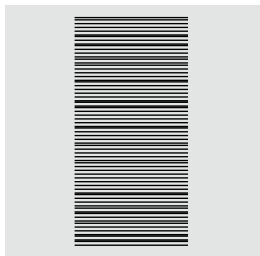
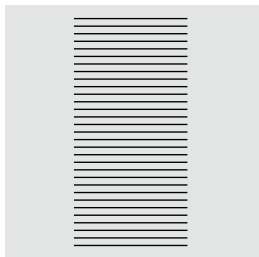

### ATTENTION!

Pulling, pushing or holding back the fabric can result in damages of the needle and stitch plate.

Pulling, pushing or holding back the fabric will result in uneven stitches.

## Feed Dog lowered/ready to sew



«Feed dog»-button 1 flush with housing.  
▶ feed dog is ready to sew

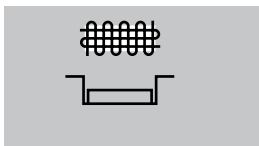

«Feed dog»-button 1 pressed.  
▶ feed dog is lowered  
For free-motion sewing (darning, embroidery, quilting, etc.).



## Functions

### Overview «Function»-buttons sewing



#### «Start/Stop»-button

- starts and stops the sewing computer when operating it **with** or **without** foot control
- starts and stops the BSR-Function if the BSR foot is attached and activated



#### «Presser foot position»-button

- touch button
- ▶ the presser foot is lowered and lifted to a hover position to position the material easily
- ▶ the presser foot is lowered on the material while starting to sew
- press the button again
- ▶ the foot is lifted

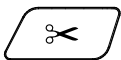

#### «Automatic thread cutter»-button

- upper and lower threads are automatically cut
- 2-6 securing stitches can be programmed in the setup program. These are sewn before the thread is cut

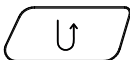

#### «Quick reverse»-button

- secures the seam beginning and end: sews in reverse as long as the button is pressed
- used to program the buttonhole length
- used to program the darning length
- used to determine end of stitching in straight stitch Securing stitch No. 5
- used for securing in Quilters securing program No. 1324



#### «Needle stop»-button

- touch button
- ▶ the needle is raised or lowered in the same way as by sinking the heel back on the foot control



#### Programmable «Pattern end/Securing»-button

- touch button before or during sewing
- ▶ single pattern is secured at the end, with the selected number of stitches programmed
- touch button before or during sewing of a combination
- ▶ the active pattern of the combination is secured at the end, with the selected number of stitches programmed
- the number and type of the securing stitches can be programmed in the setup program

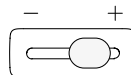

#### Speed control

- sewing speed is infinitely variable with the slide

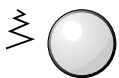

**Stitch width and Stitch length Knobs (Multifunction)**

- to adjust stitch width or stitch length
- to alter thread tension
- to set the buttonhole slit width or the button size
- to adjust the balance
- various alterations in the setup program
- various alterations when embroidering



**«Needle position»-buttons**

- press the left button
- ▶ needle moves to the left
- press the right button
- ▶ needle moves to the right
- keep button pressed
- ▶ quick change
- total of 11 needle positions (5 left, 5 right, 1 center = 0)



**Needle stop position up and «Quick Reverse»-button**

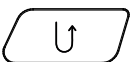

If the «Quick Reverse»-button is pressed while sewing or after stopping (e.g. zig-zag) with programmed needle stop **up**, the sewing computer sews one stitch forward before it switches to sewing in reverse.



**Needle stop position down and «Quick Reverse»-button**

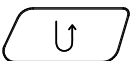

If the «Quick Reverse»-button is pressed after stopping (e.g. zig-zag) with programmed needle stop **down**, the sewing computer switches to sewing in reverse immediately.



## Display

### Overview Main Display

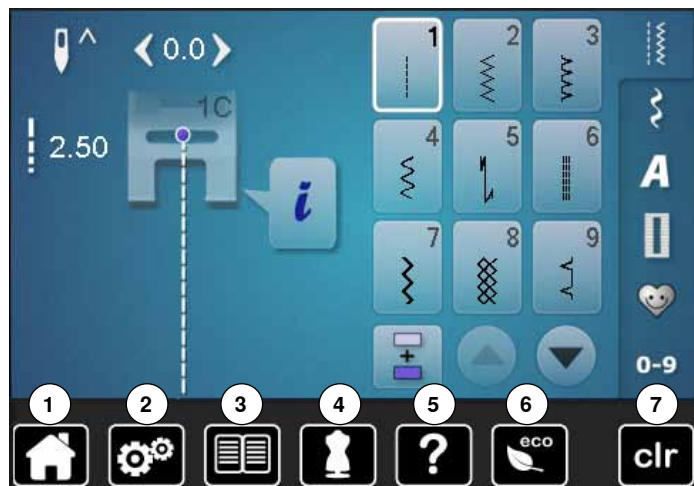

#### System settings

- 1 Home
- 2 Setup Program
- 3 Tutorial
- 4 Creative consultant
- 5 Help
- 6 ECO
- 7 Clear settings

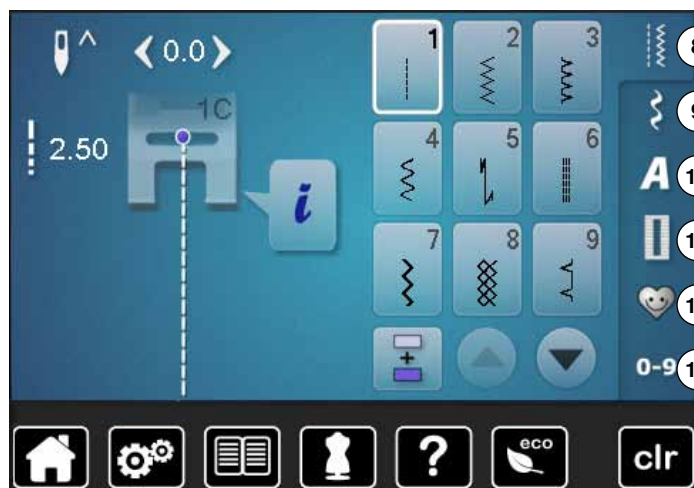

#### Menu Selection

- 8 Practical stitches
- 9 Decorative stitches
- 10 Alphabets
- 11 Buttonholes
- 12 Personal program/Memory
- 13 Stitch selection by number

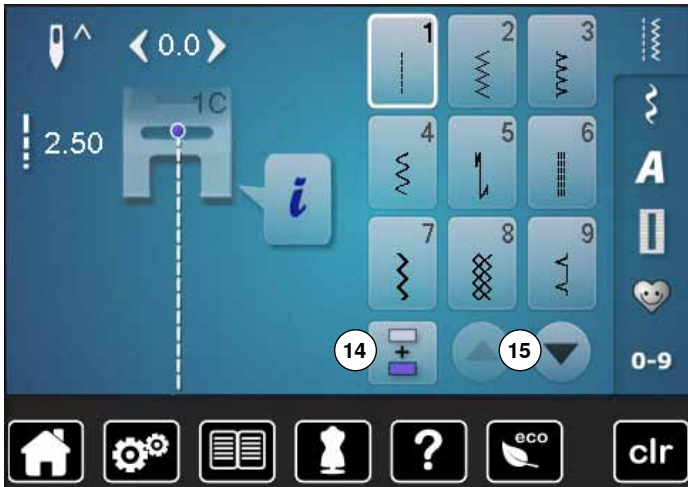

**Selection**

- 14 Single and combi mode
- 15 Scroll up/down

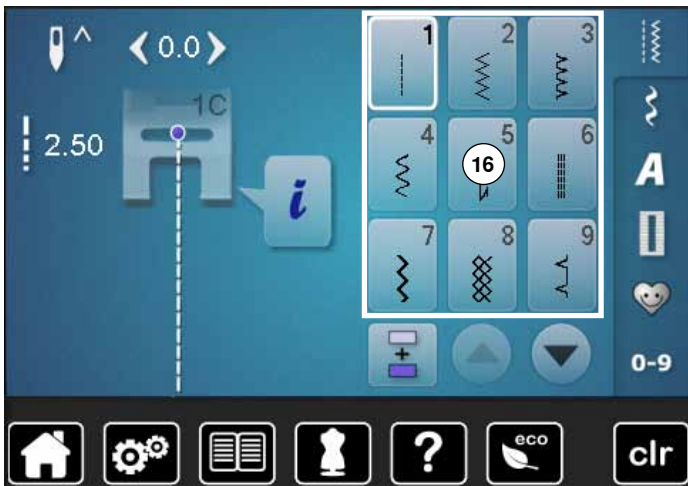

**Stitch Pattern selection**

- 16 Stitch pattern selections

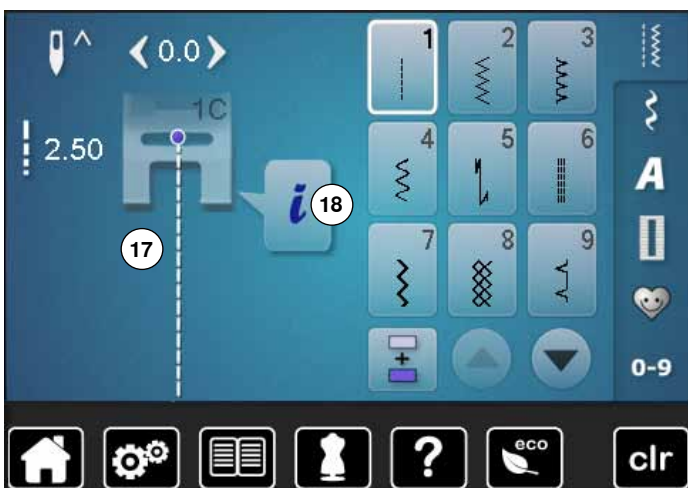

**Stitch Pattern Display**

- 17 Display of the stitch pattern selected
- 18 Information

## Functions - Display

### Overview Sewing functions

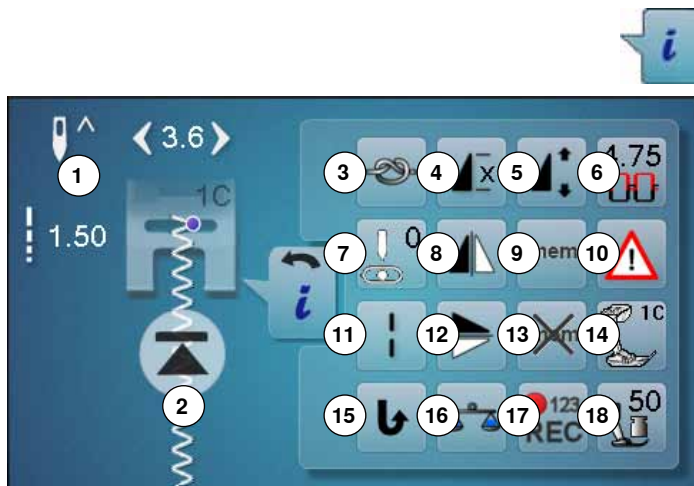

- touch «i»-icon
- ▶ «Function»-display appears

#### Functions

- 1 Needle stop up/down
- 2 Pattern begin
- 3 Securing
- 4 Pattern repeat
- 5 To alter pattern length/stitch density
- 6 Upper thread tension
- 7 Needle position
- 8 Mirror Image (Left/Right)
- 9 Personal memory permanent
- 10 Security program
- 11 Long stitch
- 12 Mirror image (Up/Down)
- 13 Clear saved setting to default
- 14 Presser foot indicator
- 15 Permanent reverse sewing
- 16 Balance
- 17 Stitch Counter
- 18 Presser foot pressure

### General functions



#### Information

- touch icon
- ▶ another Display is opened



#### Back

- touch icon
- ▶ goes back to the previous Display
- ▶ all changes are saved



#### Confirm selection

- touch icon
- ▶ activates or confirms alteration/selection



#### Leaving the active Display

- touch icon
- ▶ the Display is closed
- ▶ goes back to the previous Display



#### Securing

- touch icon before sewing
- ▶ the single stitch is secured with four stitches at the beginning
- touch icon while sewing a single pattern
- ▶ the single stitch is secured at the end
- ▶ the sewing computer stops
- to program the securing function within a stitch combination
- any single stitch of the combination can be secured at the begin or at the end



#### Pattern repeat

- touch icon 1x
- ▶ number 1 appears: the sewing computer stops at the end of a single stitch or a stitch combination
- touch icon 2-9x
- ▶ numbers 2-9 appear: the sewing computer stops after the selected repeats of single stitches or a stitch combination



#### Altering pattern length

- move the round knob in the Display using the finger
  - ▶ pattern length (Standard = 100%) is infinitely variable
  - extend or shorten in 1%-steps using the arrow icons or
  - touch «Pattern length»-icon
  - ▶ the pattern length is extended in 100%-steps
- Maximum length is 1000%, shortest length is 10%. Some stitch patterns are limited and cannot be extended to 1000%.



#### Upper thread tension

- change upper thread tension
- ▶ the respective value is visible in the icon



#### Needle stop up/down

- touch icon
- ▶ the arrow on the Display points down
- ▶ the sewing computer stops with needle down
- touch the icon again
- ▶ the arrow on the Display points up
- ▶ the sewing computer stops with needle up



#### Pattern begin

- ▶ the function appears when the sewing computer is stopped while sewing a single stitch or a stitch combination
- touch icon
- ▶ the needle moves to the beginning of a stitch pattern or program



### Altering stitch density

Certain decorative stitches (e.g. No. 401) allow an alteration of the stitch density. The set stitch pattern length will not be affected.

- touch arrow icon «up»
  - ▶ the stitch density is reduced in 0.05mm steps
  - ▶ the stitch distance is enlarged
- touch arrow icon «down»
  - ▶ the stitch density is increased in 0.05mm steps
  - ▶ the stitch distance is reduced



#### Needle position

- move the needle position to the left or to the right touching the arrow buttons left/right or using the finger
- keep arrow button pressed
  - ▶ quick moving of the needle
  - ▶ the needle position is displayed in the yellow-framed icon
- touch yellow-framed icon
  - ▶ the needle moves to the middle (position 0)



#### Mirror image (Left/Right)

The sewing computer sews the stitch pattern mirrored, left/right referring to the sewing direction.



#### Personal memory permanent

- select a stitch pattern and alter e.g. stitch length or stitch width
- touch icon
  - ▶ the altered stitch pattern is saved



#### Security program

- touch icon
- touch «Needle»- or «Stitch plate»-icon

Overview Needle:

- touch desired «Needle»-icon
  - ▶ stitch width is limited automatically
  - ▶ this prevents the inserted special needle (double needle etc.) from hitting the presser foot or the stitch plate = no needle breakage
  - ▶ numbers in the needle icons show the needle distance in mm
- touch «Standard needle»-icon
  - ▶ the standard needle is activated again
  - ▶ stitch width limitation is deactivated

Overview Stitch plates:

- touch the desired «Stitch plate»-icon
  - ▶ stitch width is limited automatically
  - ▶ this prevents the inserted needle from hitting the presser foot or the stitch plate = no needle breakage

The function remains active even when the sewing computer is turned off and on.



If the straight stitch plate is activated, the stitch width cannot be altered.



#### Long stitch

- the sewing computer sews every **second** stitch (max. stitch length 12mm)
- applicable for practical and decorative stitches

**Exception:** buttonholes, alphabets



#### Mirror image up/down

The sewing computer sews the stitch pattern mirrored up/down referring to the sewing direction.



#### Clear saved setting to default

- touch icon
  - ▶ any alterations of the selected stitch pattern are reset to basic setting



#### Presser foot indicator

- touch icon
  - ▶ the Display is opened showing the optional presser feet for the selected stitch pattern
- touch «Back»-icon
  - ▶ the Display is closed



#### Permanent reverse sewing

The sewing computer sews the selected stitch pattern in reverse.



#### Balance

Balances forward and reverse stitches.



#### Stitch Counter

- ▶ when the desired length is achieved, touch the «Quick Reverse»-button
- ▶ the display changes to «auto»
- ▶ the selected stitch pattern is temporarily programmed



#### Presser foot pressure

- alter presser foot pressure
  - ▶ the respective value is visible in the icon

## Overview Functions buttonholes



- touch «Buttonhole»-button
- select the buttonhole
- touch «i»-icon



### Altering the buttonhole

- 1 Programs the buttonhole length
- 2 Buttonhole length direct entry
- 3 Manual buttonhole
- 4 Stitch counter buttonhole
- 5 Securing
- 6 Buttonhole slit width
- 7 Balance
- 8 Upper thread tension
- 9 Security program
- 10 Presser foot indicator
- 11 Presser foot pressure



#### Programming buttonhole length

- ▶ the icon is white-framed after a buttonhole has been selected
- determine the buttonhole length by pressing the «Quick reverse»-button or
- program the indicated length directly in the icon below by touching the icon



- ▶ function becomes inactive after programming the length

- if a new length is to be programmed, touch the icon again



#### Buttonhole length direct entry

Enter the buttonhole length via the stitch width or stitch length knob. Size in mm.



#### Manual buttonhole

- sew a manual buttonhole in 5 or 7 steps (depending on buttonhole type)
- select every step by touching the arrow icons below the indicated buttonhole



#### Stitch counter buttonhole

Having sewn the desired length of the 1st bead, then

- press «Quick reverse»-button

Having sewn the desired length of the 2nd bead, then

- press «Quick reverse»-button

▶ Display shows «auto»

▶ the buttonhole is programmed



#### Securing

- touch icon before sewing
- ▶ the buttonhole is secured with four securing stitches at the beginning
- touch icon while sewing a buttonhole
- ▶ the buttonhole is secured at the end
- ▶ the sewing computer stops



**Buttonhole slit width**

- set the buttonhole slit width to between 0.1mm and 2.0mm using the stitch width or the stitch length knob or the arrow icons



**Balance**

Balances forward and reverse stitches.



**Upper thread tension**

- change upper thread tension
- ▶ the respective value is visible in the icon



**Security program**

- touch icon
- touch «Needle»- or «Stitch plate»-icon

Overview Needles:

- touch desired «Needle»-icon
- ▶ the stitch width is limited automatically
- ▶ this prevents the inserted special needle (double needle etc.) from hitting the presser foot or the stitch plate = no needle breakage
- ▶ numbers in the needle icons indicate the needle distance in mm
- touch the «Standard needle»-icon
- ▶ the standard needle is activated again
- ▶ stitch width limitation is deactivated

Overview Stitch plates:

- touch desired «Stitch plate»-icon
- ▶ the stitch width is limited automatically
- ▶ prevents the inserted needle from hitting the presser foot or the stitch plate = no needle breakage

The function remains active even when the sewing computer is turned off and on.



**Presser foot indicator**

- touch icon
- ▶ the recommended presser foot is displayed
- ▶ the active Display shows the optional presser feet for the selected stitch pattern
- touch «Back»-icon
- ▶ the Display is closed



**Presser foot pressure**

- alter presser foot pressure
- ▶ the respective value is visible in the icon

## Overview Functions Alphabets



- touch «Alphabet»-button
- select Alphabet
- touch «i»-icon

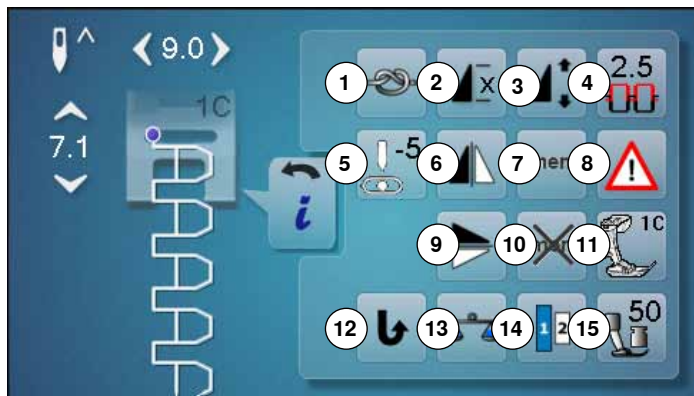

### Altering Alphabet

- 1 Securing
- 2 Pattern repeat
- 3 To alter pattern length
- 4 Thread tension
- 5 Needle position
- 6 Mirror image (Left/Right)
- 7 Personal memory permanent
- 8 Security program
- 9 Mirror image down/up
- 10 Clear saved setting to default
- 11 Presser foot indicator
- 12 Permanent reverse sewing
- 13 Balance
- 14 Lettering size in alphabets
- 15 Presser foot pressure



#### Securing

- touch icon before sewing
  - ▶ single stitch is secured at the begin with four securing stitches
- touch icon while sewing a single stitch
  - ▶ the single stitch is secured at the end
  - ▶ the sewing computer stops
- to program the securing function within a pattern combination
  - each individual pattern of the combination can be secured at the start or the end



#### Pattern repeat

- touch icon 1x
  - ▶ number 1 appears: the sewing computer stops at the end of an individual stitch or stitch combination
- touch icon 2-9x
  - ▶ numbers 2-9 appear: the sewing computer stops at the end of a stitch or a stitch combination after the number of repeats selected



#### Altering pattern length

- move the round knob in the Display using the finger
    - ▶ pattern length (Standard = 100%) is infinitely variable
  - extend/shorten in 1%-steps with the arrow icons or
  - touch «Pattern length»-icon
    - ▶ pattern length is extended in 100%-steps
- Maximum length is 200%, shortest length is 10%.



#### Upper thread tension

- change upper thread tension
  - ▶ the respective value is visible in the icon



#### Needle position

- move the needle to the left or to the right using the arrow icons left/right or the finger
- keep arrow icon pressed
- ▶ quick movement of the needle
- ▶ the needle position is displayed in the yellow-framed icon
- touch yellow-framed icon
- ▶ moves the needle to the middle (Position 0)



#### Mirror image (Left/Right)

The sewing computer sews the stitch pattern mirrored, left/right referring to the sewing direction.



#### Personal memory permanent

- select a stitch pattern and alter e.g. stitch length or stitch width
- touch icon
- ▶ the altered stitch pattern is saved



#### Security program

- touch icon
- touch «Needle»- or «Stitch plate»-icon

Overview Needle:

- touch desired «Needle»-icon
- ▶ stitch width is limited automatically
- ▶ this prevents the inserted special needle from hitting the presser foot and the stitch plate = no needle breakage
- ▶ numbers in the needle icons indicate the needle distance in mm
- touch «Standard needle»-icon
- ▶ Standard needle is activated again
- ▶ stitch width limitation is deactivated

Overview Stitch plates:

- touch the desired «Stitch plate»-icon
- ▶ stitch width is limited automatically
- ▶ this prevents the needle from hitting the presser foot and the stitch plate = no needle breakage

The function remains active even when the sewing computer is turned off and on.



#### Mirror image (Up/Down)

The sewing computer sews the stitch pattern mirrored, up/down referring to the sewing direction.



#### Clear saved setting to default

- touch icon
- ▶ any alterations of the selected stitch pattern are reset to basic setting



#### Presser foot indicator

- touch icon
- ▶ shows recommended presser foot
- ▶ the active Display shows optional presser feet for the selected stitch pattern
- touch «Back»-icon
- ▶ the Display is closed



#### Permanent reverse sewing

The sewing computer sews the selected stitch pattern in permanent reverse.



#### Balance

Balances forward and reverse stitches.



#### Lettering size in alphabets

- select alphabet
- ▶ letter size is 9mm
- touch icon
- ▶ activates number «2»
- ▶ the font size is reduced



#### Presser foot pressure

- alter the presser foot pressure
- ▶ the respective value is visible in the icon



## Overview Functions Combi mode



- touch «Combi mode»-icon
- select stitch pattern
- touch «i»-icon

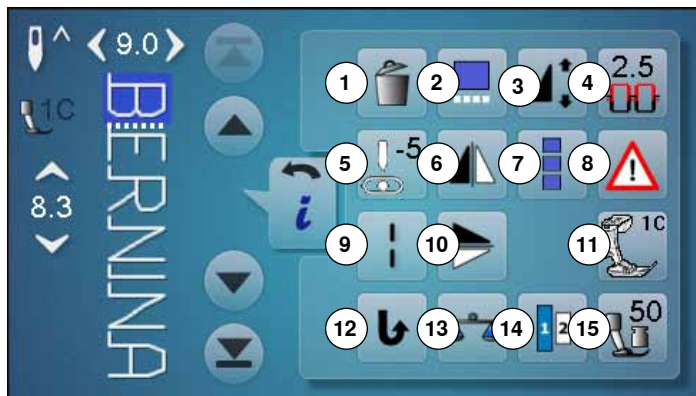

### Combi mode

- 1 Deleting
- 2 Editing combinations at cursor position
- 3 Altering the pattern length
- 4 Upper thread tension
- 5 Needle position
- 6 Mirror image (Left/Right)
- 7 To edit the whole combination
- 8 Security program
- 9 Long stitch (without alphabets)
- 10 Mirror image (Up/Down)
- 11 Presser foot indicator
- 12 Permanent reverse sewing
- 13 Balance
- 14 Lettering size in alphabets
- 15 Presser foot pressure



#### Deleting

Deletes an individual stitch.



#### Editing a combination at cursor position

- touch icon
- ▶ Display appears



#### Altering pattern length

- move the round knob in the Display using the finger
  - ▶ pattern length (Standard = 100%) is infinitely variable
  - extend/shorten in 1%-steps with the arrow icons or
  - touch «Pattern length»-icon
  - ▶ pattern length is extended in 100%-steps
- Maximum length is 1000%, shortest length 10%. Some stitch patterns are limited and cannot be extended to 1000%.



#### 4.5 Upper thread tension

- change upper thread tension
- ▶ the respective value is visible in the icon



#### Needle position

- move the needle to the left or to the right touching the arrow icons left/right or using the finger
- keep arrow icon pressed
- ▶ quick movement of the needle
- ▶ the yellow-framed icon shows the needle position
- touch yellow-framed icon
- ▶ moves the needle to the middle (Position 0)



#### Mirror image (Left/Right)

The sewing computer sews the stitch pattern mirrored, left/right referring to the sewing direction.



#### Editing the whole combination

- touch icon
- ▶ Display appears



#### Security program

- touch icon
- touch «Needle»- or «Stitch plate»-icon

##### Overview Needles:

- touch the desired «Needle»-icon
- ▶ stitch width is limited automatically
- ▶ this prevents the inserted special needle from hitting the presser foot and the stitch plate = no needle breakage
- ▶ numbers in the needle icons indicate the needle distance in mm
- touch «Standard needle»-icon
- ▶ the Standard needle is activated again
- ▶ the stitch width limitation is deactivated

##### Overview Stitch plates:

- touch the desired «Stitch plate»-icon
- ▶ stitch width is limited automatically
- ▶ this prevents the inserted needle from hitting the presser foot and the stitch plate = no needle breakage

The function remains active even when the sewing computer is turned off and on.



#### Long stitch

- the sewing computer sews every **second** stitch (max. stitch length 12mm)
- applicable for practical and decorative stitches
- **Exception:** buttonholes, alphabets



#### Mirror image (Up/Down)

The sewing computer sews the stitch pattern vertically mirrored, up/down referring to the sewing direction.



#### Presser foot indicator

- touch icon
- ▶ shows the recommended presser foot
- ▶ the active Display shows the optional presser feet for the selected stitch
- touch the «Back»-icon
- ▶ the Display is closed



#### Permanent reverse sewing

The sewing computer sews the selected stitch pattern in permanent reverse.



#### Balance

Balances forward and reverse stitches.



#### Lettering size in alphabets

- select alphabet
- ▶ letter size is 9mm
- touch icon
- ▶ activates number «2»
- ▶ the font size is reduced



#### Presser foot pressure

- alter the presser foot pressure
- ▶ the respective value is visible in the icon



- touch «Combi mode»-icon
- select the stitch pattern
- touch «i»-icon
- touch «Cursor position»-icon



**Functions**

- 1 Combination subdivider (1)
- 2 Combination subdivider (2)
- 3 Securing



**Combination subdivider (1)**

- each combination or memory folder can be subdivided into several parts
- only those parts where the cursor is located will be sewn
- to sew another part, the cursor must be placed into this part



**Combination subdivider (2)**

- each combination can be interrupted as desired
- after stopping, the needle moves to the next part to be sewn



**Securing**

- program the function within a pattern combination
- each individual pattern of the combination can be secured at the start or the end



- touch «Combi mode»-icon
- select stitch pattern
- touch «i»-icon
- touch «Edit whole combination»-icon

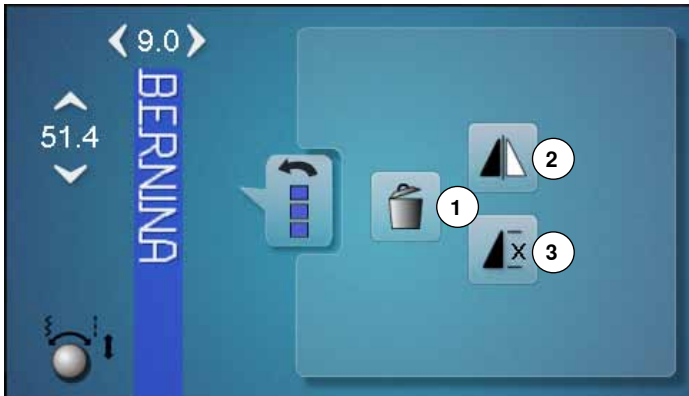

#### Functions

- 1 Deleting
- 2 Mirror Image (Left/Right)
- 3 Combination repeat



#### Deleting

Deletes the whole combination.



#### Mirror image (Left/Right)

The sewing computer sews the whole combination mirrored, left/right referring to the sewing direction.



#### Combination repeat

- touch icon 1x
- ▶ number 1 appears: the sewing computer stops at the end of a pattern combination
- touch icon 2-9x
- ▶ numbers 2-9 appear: the sewing computer stops at the end of a stitch combination after the selected number of repeats

## Setup Program

### Overview «Setup»-display

The Setup Program enables an individual adjustment of the Display surface and the settings according to your personal requirements.

After setting the sewing computer to your personal requirements, all changes made in the Setup Program are saved, even when the sewing computer is switched off.

Exceptions from this rule are outlined within the description of the function concerned in each case.



- touch «Setup Program»-button
- ▶ «Setup Program»-display is opened



- 1 Display settings
- 2 Display color
- 3 Sewing settings
- 4 Embroidery settings
- 5 Display calibration
- 6 Audio System
- 7 Monitoring
- 8 Winding speed
- 9 Update sewing computer
- 10 Calibration buttonhole foot No. 3A/Cleaning/Packing position
- 11 Basic setting
- 12 Information



Touch the yellow-framed icon to reset to basic setting.

## Changing Display settings



- touch «Display setting»-icon

### Brightness

- move the round knob in the Display to the left/right using the finger or
- turn the stitch width knob
- ▶ the brightness **1** of the Display changes
- ▶ alterations are visible in the yellow-framed icon
- ▶ a white line indicates the basic setting

### Sewing light

- ▶ when icon **2** is active, the sewing light is on
- ▶ when icon **2** is inactive, the sewing light is off

### Brightness sewing light

- move the round knob in the Display to the left/right using the finger or
- turn the stitch length knob
- ▶ the brightness **3** of the sewing light changes
- ▶ alterations are visible in the yellow-framed icon
- ▶ a white line indicates the basic setting



### Welcome text

- create or change Welcome Text **4**
- The space button is below the keyboard.
- ▶ Welcome text appears in the text icon **5** above the letter keys
- touch ✓ to confirm

### Deleting Welcome text

- touch «Text»-icon **5**
- ▶ the entered text is completely deleted

### Corrections

- touch icon **6**
- ▶ the entered text is deleted from the right to the left



- 7** «ABC» all in upper case (Standard)
- 8** «abc» all in lower case
- 9** «Ä Å Á», «ä à á» and «@ #» upper and lower special characters
- 10** «1,2,3» numbers and mathematical characters

## Setup Program

### Selecting the Display color



- touch «Display color»-icon
- select the desired display color

### Sewing settings

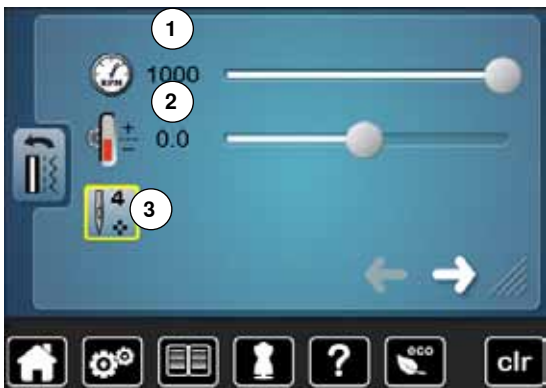

- touch «Sewing setting»-icon

#### Sewing speed

- move the round knob in the Display to the left/right using the finger or
- turn the stitch width knob
- ▶ alters the maximal sewing speed **1**
- ▶ the number in the yellow-framed icon indicates the stitches per minute, the basic value is indicated by a white line

#### Altering the upper thread tension

- move the round knob in the Display to the left/right using the finger or
  - turn the stitch length knob
  - alters the basic setting of the upper thread tension **2** at plus or minus two basic values
- 0.0 = basic setting



Alterations of the upper thread tension and the sewing speed affect any stitch patterns and embroidery motifs and remain active even when the sewing-/embroidery computer is switched off.

#### Securing stitches at pattern begin

- ▶ the function is active (standard)
- ▶ 4 securing stitches are sewn before a stitch pattern starts
- touch icon **3**
- ▶ function is inactive = no securing stitches will be sewn



- touch icon

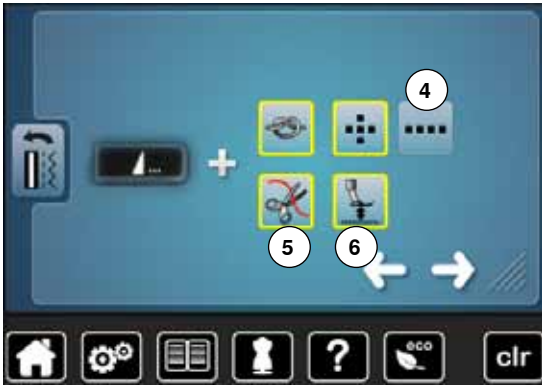

#### Automatic securing program at pattern end

- the number and type of the securing stitches of the **external** «Pattern end/Securing»-button can be programmed
- standard = four securing stitches in the same place
- select function **4** for forward securing stitches
- via the arrow icons three to six securing stitches can be programmed

#### Automatic thread cutter

- ▶ if function **5** is activated, the upper and lower thread are automatically cut after sewing

#### Raising the presser foot

- ▶ if function **6** is activated the presser foot is raised after securing
- ▶ if function is not activated, the presser foot remains down

- touch icon

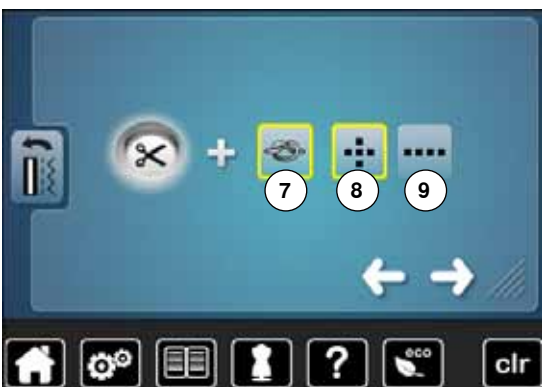

#### Automatic thread cutter and securing stitches

- the number and type of the securing stitches before the thread is cut can be programmed
- standard = no securing stitches programmed
- touch icon **7**
- ▶ icon **8** is activated
- ▶ four securing stitches are sewn at the place
- select icon **9** to secure with small stitches sewn in a forward direction
- via the arrow icons icons two to six securing stitches can be programmed

- touch icon

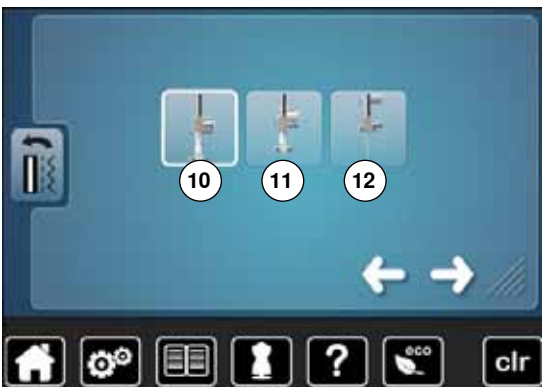

#### Presser foot position when needle stop down

- ▶ with activated icon **10**, the presser foot remains down when the sewing computer stops
- ▶ with activated icon **11**, the presser foot is raised enough to pivot the fabric (hover position)
- ▶ with activated icon **12**, the presser foot is raised into its highest position

- touch icon



#### Presser foot in hover position

- turn the stitch width or stitch length knob or
- touch arrow icons up/down or
- move the round knob in the display using the finger
- ▶ the margin of lifting can be adjusted from 0mm to 7mm. Standard = 2mm
- ▶ the respective value = the distance between material and presser foot, is displayed in the icon **13**

#### Reset settings

- touch the yellow-framed icon
- ▶ basic setting is restored



## Adjusting embroidery settings



- touch «Embroidery settings»-icon

The settings for embroidery speed and the upper thread tension can be adjusted in the same way like the settings for sewing. (see page 46)

- touch icon 1
  - ▶ when changing the thread color the automatic cut of the thread is activated or deactivated
- touch icon 2
  - ▶ to turn automatic thread cutter on or off
- touch icon 3
  - ▶ activate or deactivate securing stitches. Standard = activated
  - ▶ i.e. after selecting an embroidery motif or cutting the threads using the automatic thread cutter will trigger the stitching of 3 securing stitches
  - ▶ function is inactive = no securing stitches will be stitched, i.e. the lower thread must be taken up either manually (handwheel) or by «back heel kicking» the foot control. The threads must be held when starting to embroider
- touch icon 4
  - ▶ to calibrate the hoop

### Calibrating the hoop

The hoop calibration adjusts the needle to the center of the hoop. Adjustments can only be done if the embroidery module is attached.

- select the required hoop and follow the instructions on the screen



- place embroidery template into the embroidery hoop
  - ▶ the hoop is checked and the needle positioned to the center
- if the needle is **not** positioned exactly in the center of the embroidery template, it has to be centered by using the arrow icons
- touch icon ✓ until the selection menu appears
  - ▶ the adjustment is saved



Place the fabric in the embroidery hoop. The embroidery template is located well in the hoop.

## Display Calibration



The Display calibration can be opened as follows:

- turn off the sewing-/embroidery computer
- touch the two needle positioning buttons on the front panel and keep them pressed
- turn on the sewing-/embroidery computer and release the buttons as soon as the Display appears



- touch «Display calibration»-icon

- touch the calibration icon

- touch the center of the cross using a blunt pen
- ▶ the cross moves to the next position
- repeat this until all three positions shown are calibrated
- ▶ the Display is closed
- ▶ the calibration is saved

## Altering the acoustic signals



- touch «Acoustic signal»-icon

By touching **1** the signals are activated or deactivated.

### Selecting Stitch Pattern/Function/BSR

Stitch patterns and function selection **2** can be confirmed acoustically.

- touch the icon **3** with the loudspeakers for the stitch patterns until you hear the desired sound

There are six different sounds to choose from.

- ▶ the sound is indicated by a number (1-6)
- the sounds for the functions **4** and the sound for quilting with the BSR **5** can be activated or deactivated in the same way
- ▶ the deactivation is indicated as last option when clicking through the different sounds

## Monitoring



- touch «Monitoring»-icon



The following monitoring functions can be activated or deactivated:

- 1 Upper thread indicator
- 2 Lower thread indicator

### Upper-/Lower thread indicator

- ▶ open eye = function active
- touch «Open eye»-icon
- ▶ closed eye = function inactive

The sound type for the monitoring functions is set in the audio settings for functions.

## Altering the winding speed



- touch «Winding speed»-icon

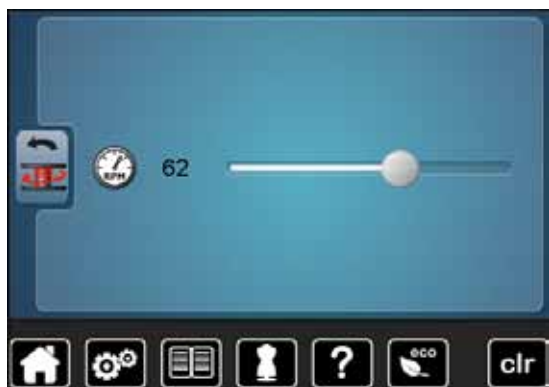

- move round knob in the Display to the left/right using the finger or
- turn the stitch width knob
- ▶ the winding speed is changed

## Update



**Do not remove the BERNINA USB stick until there is a message which indicates the end of the update.**



- insert BERNINA USB stick with the new software version
- touch «Update»-icon



It is recommended to save the data and the settings of the sewing computer before the update is carried out.

- touch icon 1
- the data of the sewing computer is saved on the USB Stick
- touch «Update»-icon 2 to start the procedure

It is then checked if:

- ▶ a BERNINA USB stick is inserted
- ▶ there is enough free space available
- ▶ the correct software version is on the stick
- ▶ the data and settings are accepted

After the successful update a message appears and sewing-/embroidery computer is ready for use.



- ▶ if the update cannot be started or if there are problems during the update process, an error message appears
- If the data and the settings aren't on the sewing computer anymore after the update:
  - touch icon 3
  - ▶ the data on the stick are saved on the sewing computer

 Please find the latest version of Software at [www.bernina.com](http://www.bernina.com)

## Calibrating buttonhole foot No. 3A/Cleaning/Packing position



- touch «Cleaning/Calibrating»-icon

- 1 Calibrating Buttonhole foot No. 3A
- 2 Cleaning the thread catcher
- 3 Packing position



- touch «Calibration»-icon

- attach buttonhole foot No. 3A
  - touch «Start/Stop»-button
  - ▶ the buttonhole foot No. 3A moves forward and backwards
  - ▶ the buttonhole foot No. 3A is calibrated and the sewing computer indicates whether the calibration has been successful
- The buttonhole foot No. 3A is matched to this sewing computer and should only be used on this sewing computer.



- touch «Cleaning»-icon
- clean the thread catcher according to the instructions

## Setup Program

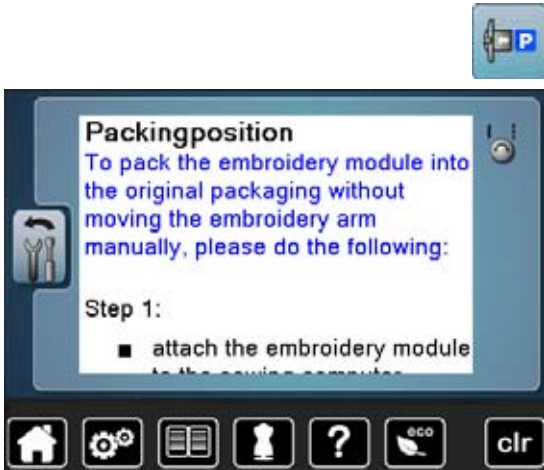

- touch «Packing position»-icon

The embroidery module must be connected with the sewing computer.  
▶ the embroidery arm of the embroidery module moves to packing position  
The embroidery arm of the embroidery module must not be moved manually.  
By means of this function the embroidery module can be stored in the original box.

## Reset/Delete user data



- touch «Basic settings»-icon

Choose from following options:

- 1 Reset Settings
- 2 Delete user data

### Reset settings

- touch icon 1

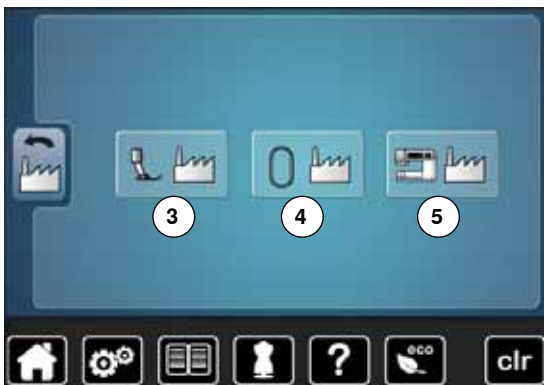

Choose from following options:

- 3 Reset Sewing
- 4 Reset Embroidery
- 5 Reset All

- touch the icon, whose settings should be reset to basic setting
- confirm with ✓
- ▶ the previous Display appears
- touch «Back»-icon
- ▶ selection menu appears

### Exceptions:

Thread tension, brilliance, brightness, display color and speed need to be reset to basic state knowingly according to the corresponding function.

### Delete user data

- touch icon 2





Choose from following options:

- 6 Sewing «Personal program»
- 7 Embroidery «My Designs»
- 8 Embroidery «Memory stick» (the Memory stick must be inserted in the sewing computer)

- touch the icon, whose data should be deleted
- confirm with ✓
- ▶ the data is deleted and the previous Display appears
- touch «Back»-icon
- ▶ selection menu appears

## Information



- touch «i»-icon



### Language

- scroll through the languages by touching the arrow icons and select the language required



- touch icon



### Version

- ▶ the present version of the sewing computer and the attached embroidery module are visible
- ▶ the total number of stitches and the number of stitches sewn since the last servicing by the dealer are displayed



- touch icon

## Setup Program



### Dealer details

- touch respective icon
- Following details of the BERNINA-dealer can be registered:
- store name
  - address
  - telephone number
  - website or e-mail address



- touch icon



### Service data

The service data of the present condition of the sewing-/embroidery computer can be saved on a memory stick and sent to the BERNINA-dealer:

- insert memory stick to sewing-/embroidery computer
- touch «LOG»-icon
- ▶ data is saved on the memory stick
- remove memory stick

# Tutorial

## Overview Tutorial

The tutorial provides information and explanations about the different areas of sewing.



- touch «Tutorial»-button
- ▶ «Tutorial»-display appears

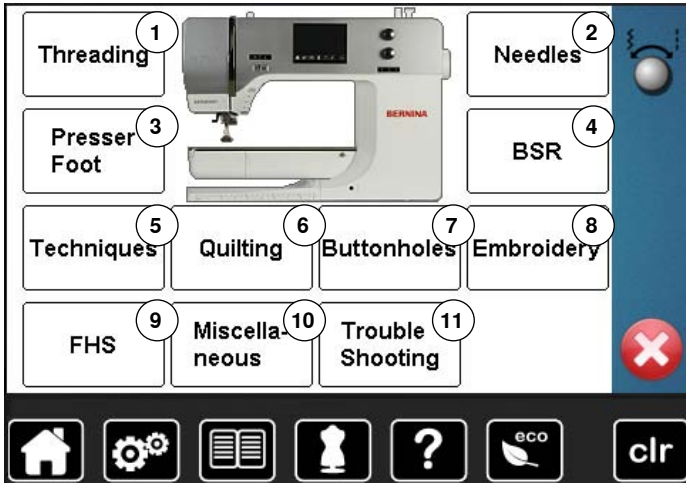

- 1 Threading
- 2 Needles
- 3 Presser foot
- 4 BSR
- 5 Sewing techniques
- 6 Quilting
- 7 Buttonholes
- 8 Embroidery
- 9 Free Hand System (FHS)
- 10 Miscellaneous
- 11 Troubleshooting



- select desired topic, e.g. presser foot
- ▶ topic overview about the presser foot appears
- select desired topic, e.g. changing the presser foot



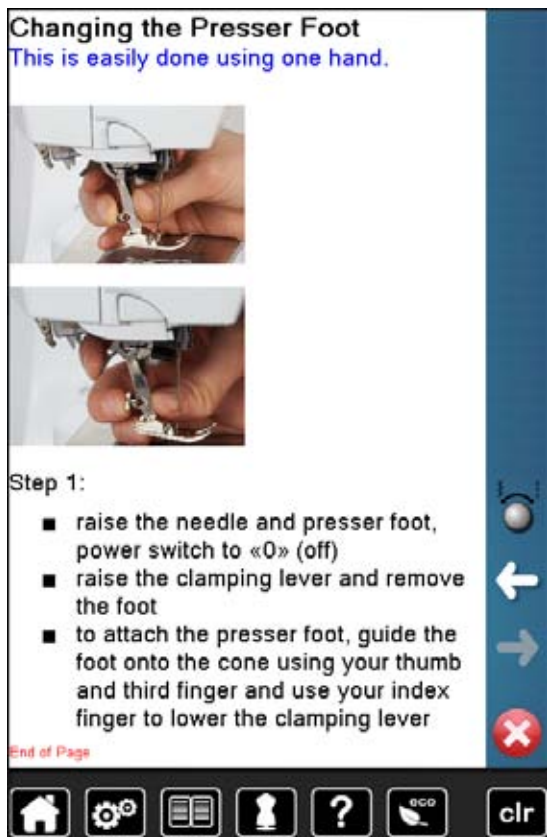

- ▶ information on the desired topic is shown
- scroll through the topics using the knobs or the finger



- touch «Next»
- ▶ the next page appears



- touch «Back»
- ▶ the previous page appears

- touch **X**
- ▶ the «Tutorial»-display closes
- ▶ the previous Display appears

## Creative consultant

### Overview Creative consultant

The creative consultant provides information and help with various sewing techniques. After selecting the fabric and the desired sewing technique suggestions for suitable needles, presser feet etc. are displayed.

► presser foot pressure and upper thread tension are set automatically

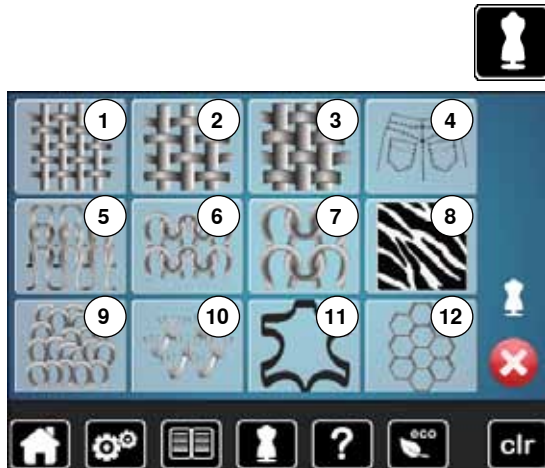

- touch «Creative consultant»-button
- «Creative consultant»-display appears

- 1 Light weight woven
- 2 Medium weight woven
- 3 Heavy weight woven
- 4 Jeans
- 5 Light weight knit
- 6 Medium weight knit
- 7 Heavy weight knit
- 8 Fur
- 9 Toweling
- 10 Fabric with a pile
- 11 Leather and Vinyl
- 12 Tulle and Laces

### Overview Sewing techniques



- touch icon of the desired material, e.g. light weight woven

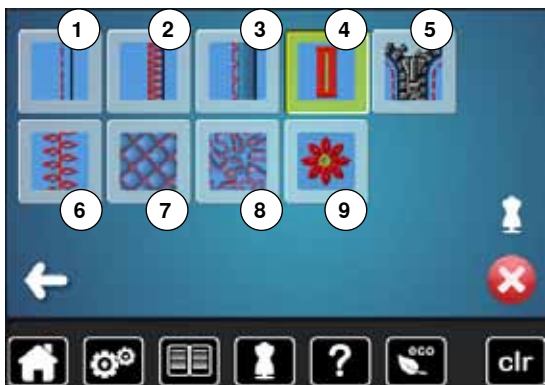

The optional sewing techniques are displayed.

- 1 Seams
- 2 Overcasting
- 3 Blind hem
- 4 Buttonhole
- 5 Zipper
- 6 Decorative stitching
- 7 Machine quilting
- 8 Free-motion stitching
- 9 Appliqué



- select the desired sewing technique, e.g. buttonhole
- If the desired sewing technique is not in the list, choose a similar sewing technique.



- recommendations for the selected material and the desired sewing technique is displayed
- confirm with ✓
- display with the programmed stitch patterns appears

#### Leaving the sewing consultant

- touch ✗

## Help program

The Help program provides information about individual stitch patterns and function icons in the Display.



- touch «Help program»-button
- select the desired stitch pattern or the desired function



### Stitch patterns

The Display shows the following information:

- ▶ stitch pattern name
- ▶ suitable materials
- ▶ recommendation

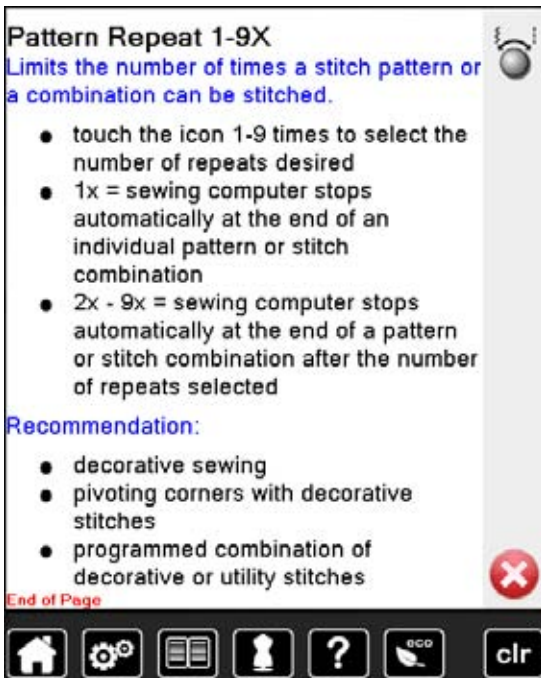

### Functions

The Display shows the following information:

- ▶ function name
- ▶ function explanation
- ▶ recommendation

- touch **X**
- ▶ the Help program is closed
- ▶ the previous Display appears

## Balance

### Practical and decorative stitches

The sewing computer is tested and optimally set before it leaves the BERNINA factory. Different fabrics, threads and stabilizers can affect programmed stitches so that they are not sewn out properly. These effects can be corrected with the electronic Balance so that the stitch formation can be adjusted where necessary to suit the material.

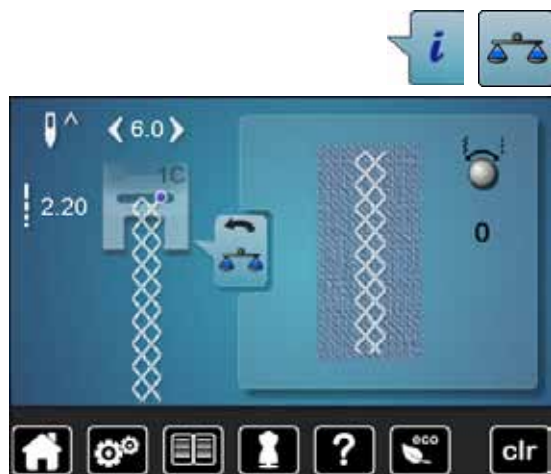

- touch «i»-icon
- touch «Balance»-icon

- ▶ in the left part of the Display the stitch pattern is shown as it is set originally (programmed)
- ▶ in the right part of the Display any alterations are directly visible



#### Corrections

The stitch sewn on the fabric (e.g. the Honeycomb stitch) opens up and it does not look correct:

- adjust the stitch length by turning the stitch width or stitch length knob, until the stitch in the right part of the Display is identical with the stitch on the fabric
- ▶ the alteration is shown with a number in the yellow-framed icon
- touch «Back»-icon 2x
- ▶ alterations are saved
- ▶ the previous Display appears

#### Reset settings

- touch «i»-icon
- touch yellow-framed «Balance»-icon
- touch yellow-framed icon
- ▶ basic setting is reset



## eco description

When work is interrupted for longer periods, the sewing-/embroidery computer can be put into energy-saving mode.



### Activating eco

- touch «eco»-button
- ▶ the Display gets dark
- ▶ power consumption is reduced and the sewing light turned off

The energy-saving mode also acts as a child safety feature. The Display is inactive and the sewing-/embroidery computer cannot be started.

### Deactivating eco

- touch «eco»-button
- ▶ the sewing-/embroidery computer is ready for use





## Practical stitches

### Overview Practical stitches

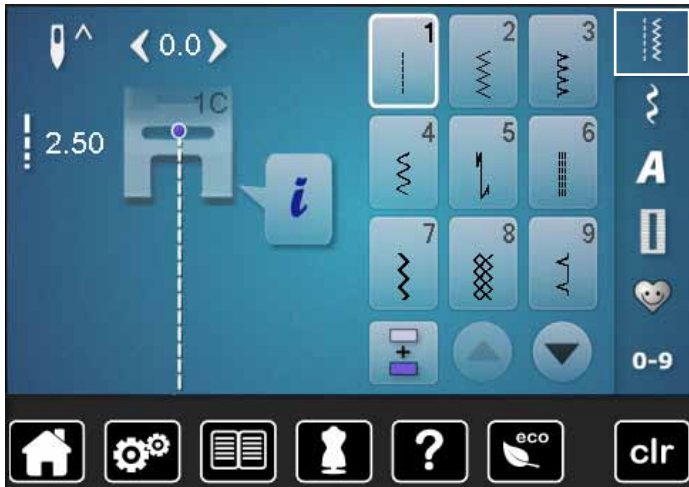

- touch «Practical stitch»-button
- ▶ the practical stitches are visible in the Display
- further practical stitches are visible by scrolling



#### **Straight stitch**

For non-elastic materials; all straight stitch work, such as seams, topstitching, sewing zippers



#### **Zig-zag**

Zig-zag work such as overcasting edges, attaching elastic and lace



#### **Vari overlock**

For fine jerseys; stretch overlock seams, hems and stretch seams



#### **Running stitch**

Most types of fabric; Mending, patching, reinforcing seams, etc.



#### **Securing program**

For all materials; secures the beginning and end of seams by straight stitching



#### **Triple straight stitch**

Reinforced seams in heavy fabrics, visible hems and seams



#### **Triple zig-zag**

Reinforced seams in heavy fabrics; visible hems and seams



#### **Honeycomb stitch**

For all types of jersey and smooth materials; visible seams in lingerie, clothing, linen, mending etc.



#### **Blind stitch**

For most types of materials; Blind hems; shell edging effect on soft jerseys and fine material; decorative seams



#### **Double overlock**

For any knit materials; overlock seam = sewing and finishing in one step



#### **Super stretch stitch**

For highly elastic fabrics; Highly elastic open seam for all types of clothing

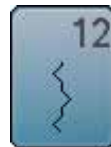

#### **Gathering stitch**

Most types of fabric; Gathering with shirring elastic. Butted seams = butting two pressed edges and sewing together, decorative stitches



#### **Stretch overlock**

For medium weight knits, toweling and firm woven; Overlock seams, flat joining seams



#### **Tricotstich**

For jersey materials; visible hems, visible seams in lingerie, sweaters, mending jersey



**15 Universal stitch**  
For firm fabrics such as felt and leather; flat joining seams, visible seams, attaching elastic, decorative seams



**16 Sewn out zig-zag**  
Edge finishing and reinforcing, attaching elastic, decorative seam



**17 Lycra stitch**  
All two-way stretch fabrics; flat joining seams and hems, reinforced seaming on underwear



**18 Stretch stitch**  
For highly elastic fabrics; open seam for sportswear



**19 Reinforced overlock**  
For medium-weight knitware and toweling; overlock seams, flat joining seams

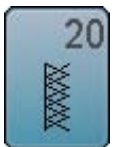

**20 Knit overlock**  
For knit material, hand- and machine made items; overlock seam = sewing and finishing in one step



**21 Basting stitch**  
Basting seams, hems, etc. temporarily



**22 Simple darning program**  
Automatic darning of fine to medium weight materials



**23 Reinforced darning program**  
Automatic darning of firm materials



**24 Bartack program**  
Reinforcing pocket openings, sewing belt loops etc.

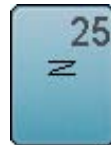

**25 Bartack program**  
Reinforcing pocket openings, sewing on belt loops, securing zippers and seam ends



**26 Large fly stitch**  
For medium weight to thick materials; reinforcing pocket openings, zippers and slits

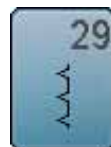

**29 Blindstitch narrow**  
For blind hems in fine materials



**31 Triple Straight Stitch with Long stitch**  
Reinforced seams in heavy fabrics, visible seams and topstitching

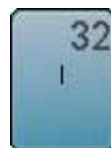

**32 Single straight stitch**  
As a connecting stitch between two individual decorative stitch patterns in a combination

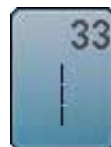

**33 Three single straight stitches**  
As a connecting stitch between two individual decorative stitch patterns in a combination



## Stitch pattern selection



**Selecting stitch pattern**

- select the desired main category **1-5**

- 1 Practical stitches
- 2 Decorative stitches
- 3 Alphabets
- 4 Buttonholes
- 5 Personal program/Memory

- ▶ the available stitch patterns are visible in the Display portion **6**
- select desired stitch pattern
- further stitch patterns are visible when scrolling **7**

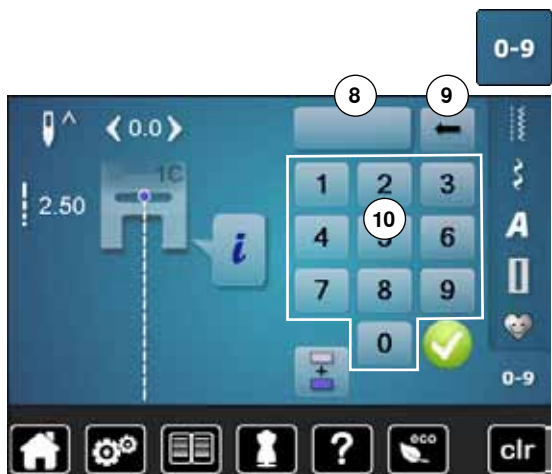

**By stitch number**

- touch «0-9»-button
- ▶ numbers for entering are visible in the Display portion **10**
- enter stitch number
- ▶ the entered stitch number appears in the icon **8**
- touch icon **9**
- ▶ last digit is deleted
- touch icon **8**
- ▶ complete number is deleted
- confirm with ✓

**Cancelling**

- touch «0-9»-button
- ▶ the previous Display appears



An invalid stitch number will be indicated in icon **8** with 3 question marks.

## Customizing stitch pattern individually

According to material and purpose a stitch pattern can be altered individually. The alterations described here are applicable for all practical and many decorative stitches.



The personal memory is unlimited; it can hold as many stitch alterations as needed:

- Stitch length
- Stitch width
- Needle position
- Pattern Extend
- Mirror images
- Long Stitch function
- Thread tension
- Balance
- Pattern repeat 1-9x

## Temporary Altered Stitch Memory

Any altered stitch width and stitch length is automatically saved.

### Example:

- sew with an altered stitch (e.g. zig-zag)
- select and sew another stitch, e.g. straight stitch
- when selecting the individually altered zig-zag again, your alterations are still active

### Return to basic settings

Individual stitch patterns can be reverted to basic settings manually.

- touch stitch width/stitch length icon and in the respective Display the yellow-framed icon or
- press the «clr»-button
- ▶ any altered values of the **active** stitch return to basic setting
- switch off the sewing computer
- ▶ any alterations of all stitches are deleted

## Personal memory permanent

The basic settings programmed by BERNINA can be altered and saved and remain active even when the sewing computer is switched off.



### Altering basic settings

- select stitch pattern, e.g. zig-zag
- alter stitch width and stitch length via the knobs



### Saving alterations

- touch «i»-icon
- touch «mem»-icon
- touch «Back»-icon
- ▶ the alterations are saved



### Back to basic settings

- touch «i»-icon
- touch «memX»-icon
- touch «Back»-icon
- ▶ the basic setting is reset

## Altering stitch width and stitch length



- turn the knobs or
  - touch stitch width or stitch length Display
  - touch the arrow icons in the respective Display or
  - move the round knob in the Display using the finger
- Can be altered while sewing.

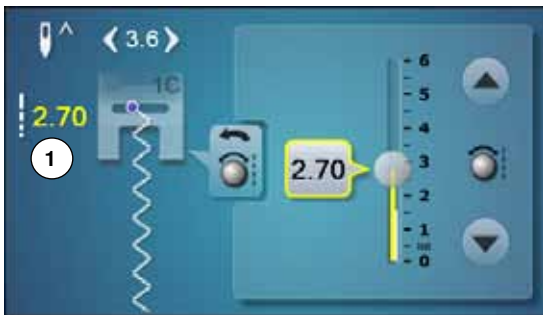

When sewing practical or quilting stitches the actual stitch length **1** is displayed.



With other stitch patterns, including alphabets, the overall length of a stitch pattern **2** is displayed. The actual stitch length **3** is visible when the stitch length Display is opened.



### Altering needle position

- touch «Moving»-buttons for needle position or



- touch «i»-icon
- touch «Needle position»-icon

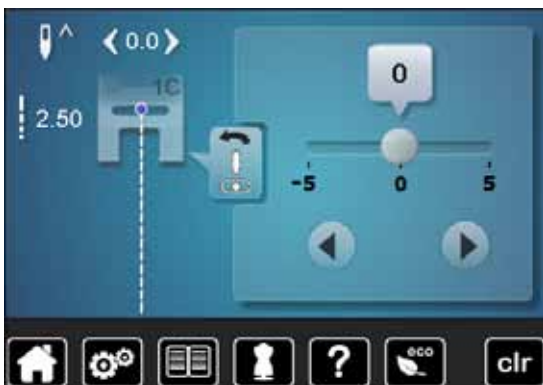

- keep «Moving»-buttons or arrow icons pressed
  - ▶ quick movement of the needle
  - move the bar in the Display using the finger
- 11 needle positions in total (5 left, 5 right, 1 center = 0).

## Examples of application Practical stitches

### Straight stitch



Reverse pattern foot No. 1C/1D

#### Straight stitch No. 1

After turning on the sewing computer the straight stitch will appear.  
▶ the needle is up

#### Application

Suitable for all fabrics.



#### Adjust the stitch length to suit the fabric

E. g. use a longer stitch length (approximately 3-4mm) with denim, a shorter length with fine fabric (approx. 2-2.5mm).

#### Adjust the stitch length to suit the thread

E. g. use a longer stitch length thread when using cordonnnet thread for topstitching (approx. 3-5mm).

#### Activate needle stop down

Prevents the fabric from shifting when you adjust or pivot the sewing project.

### Triple straight stitch



Reverse pattern foot No. 1C/1D

#### Triple straight stitch No. 6

#### Open seam

Durable seam for firm or dense materials such as denim and corduroy.



#### For firm or densely woven materials

A Jeans needle and Jeans foot No. 8 (optional accessory) will help when sewing denim or canvas.

#### Decorative top stitch

Lengthen stitch and use the triple straight stitch for decorative topstitching.

## Triple Zig-Zag



**Reverse pattern foot No. 1C/1D**

**Triple zig-zag No. 7**

In firm materials, particularly for denim, deckchair covers, awnings.



Seams on often washed items. Finish raw edges first. Use Jeans needle for very firm materials.

## Zipper

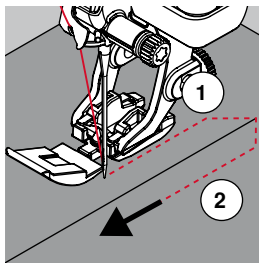
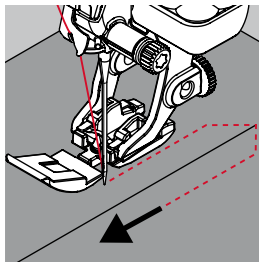

### Zipper foot No. 4D

### Straight stitch No. 1

#### Preparation

- close seam to the zipper beginning
- sew securing stitches
- baste seam closed and clean
- finish the seam allowance
- iron the seam
- open the zipper
- baste the zipper: baste or pin zipper in place so that fabric folded edges meet over the center of the zipper

#### Sewing in the zipper

- open zipper a little
- move needle position to the right
- start sewing from top left
- position the foot so the needle stitches along the edge of the zipper coils
- stop in front of the pull (needle position down)
- raise the presser foot
- close the zipper again
- continue to sew, stop in front of the base of the zipper, needle position down
- raise the presser foot
- turn the sewing project
- sew across the seam, stop with needle position down
- raise the presser foot
- turn sewing project again
- sew the second side from bottom to top

#### Variation: Sew both sides of zipper from bottom to top

Suitable for all fabrics with nap or grain (e.g. velvet).

- prepare zipper as described above
- start sewing in the seam of the zipper end and sew first side from bottom to top, needle position on the right
- sew diagonal along the edge of the zipper coils
- first side **1** sew from bottom to top
- move needle position to the left
- second side **2** sew in the same way from bottom to top



#### Sew around the zipper pull

- sew up to about 5cm away from the zipper pull
- stop with the needle down, raise the presser foot, open the zipper, finish sewing (use Free Hand System)

#### Seam begin

- hold thread firmly when starting to sew = pull fabric slightly to the back (fewer stitches) or
- sew about 1-2cm reverse first, and continue to sew as usual

#### Zipper or fabric is thick or densely woven

For even stitch formation use a 90-100 needle.

## Manual darning

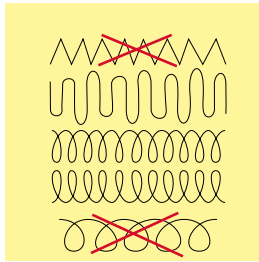

### Darning foot No. 9 (optional accessory)

### Straight stitch No. 1

#### Holes or worn areas

«Replacing» threads along the lengthside and crosswise in every material.

#### Preparation

- lower the feed dog
- attach the Slide-on table
- hoop the fabric into a round embroidery hoop (optional accessory)
- ▶ the darning area stays evenly taut and cannot be distorted

#### Sewing

- work from the left to the right, guide the fabric evenly without using pressure
- move in curves when changing direction on top and on bottom. Avoid points as this can cause holes and thread breakage
- sew different length. The thread is better spread over the fabric

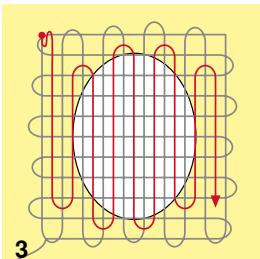
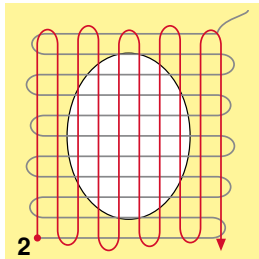
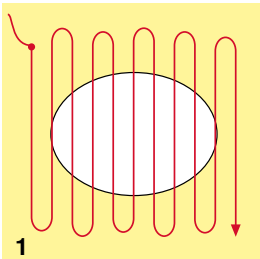

#### 1 Sew the first rows to cover the hole

- first rows just beyond the worn area and not too close together
- work the rows in irregular lengths
- turn work by a quarter turn -90°

#### 2 Sew over the first rows

- first rows not too close
- turn fabric by half turn -180°

#### 3 Finish darning the hole

- sew another loose row



#### Poor stitch formation

- if the thread is lying on top, slow down the fabric movement
- if there are knots on the wrong side of the fabric, move the fabric more quickly

#### Thread breaks

Guide the fabric more consistently.



## Automatic darning

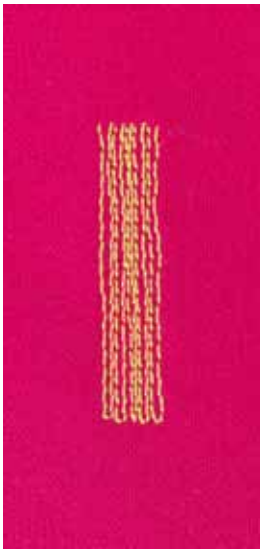

**Reverse pattern foot No. 1C**  
**Buttonhole foot No. 3A**

### Simple darning program No. 22

#### Quick darning of holes or worn areas

Replaces threads along the lengthwise grain in all materials.

#### Preparation

- hoop light weight materials in a round embroidery hoop (optional accessory)
- ▶ the darning area stays evenly taut and cannot be distorted

#### Darning with reverse pattern foot No. 1C

Start sewing top left.

- sew first row
- stop sewing computer
- press «Quick reverse»-button
- ▶ the length is programmed
- finish sewing the darning program
- ▶ the sewing computer stops automatically
- press the «clr»-button
- ▶ the program is cleared

#### Darning with the buttonhole foot No. 3A

- for darning worn and damaged areas
- darning length max. 3cm
- same procedure as with Reverse pattern foot No. 1C



#### Reinforcement

Use fine material or (adhesive) interlining as a backing.

#### If the darning becomes distorted

Correct with the Balance function (more about Balance-Function see page 59).

## Reinforced darning, automatic



### Buttonhole foot No. 3A

### Reinforced darning program No. 23

#### Quick darning of holes or worn areas

Replaces threads along the lengthwise grain in all materials.

#### Preparation

- hoop light weight materials in a round embroidery hoop (optional accessory)
- ▶ the darning area stays evenly taut and cannot be distorted

#### Darning with the buttonhole foot No. 3A

Insert the needle in the top left of the worn area.

- sew first row
- stop sewing computer
- press «Quick reverse»-button
- ▶ the length is programmed
- finish sewing the darning program
- ▶ the sewing computer stops automatically
- press the «clr»-button
- ▶ the programmed settings are cleared



#### If the darning does not cover the whole worn or damaged area

Reposition the work under the foot to continue covering the worn or damaged area. Begin sewing; the program will repeat as often as desired (the length is saved).



Per «Direct entry length» (see page 36) a darning length up to 30mm can be programmed.

## Finishing edges



### Reverse pattern foot No. 1C

### Zig-zag No. 2

- for all fabrics
- for finishing raw edges
- elastic seams
- decorative sewing

#### Finishing edges

- guide edge of fabric into the center of the presser foot
- do not select too wide a stitch
- do not select too long a stitch
- needle goes into fabric on one side and over the edge into the air on the other side
- the edge of the fabric should lie flat and not roll
- use darning thread for fine materials

#### Satin stitch

- dense, short zig-zag (stitch length 0.5-0.7mm)
- use satin stitch for appliqué, embroidery, etc



As a variation the satin stitch No. 1354 can be used.

## Double overlock

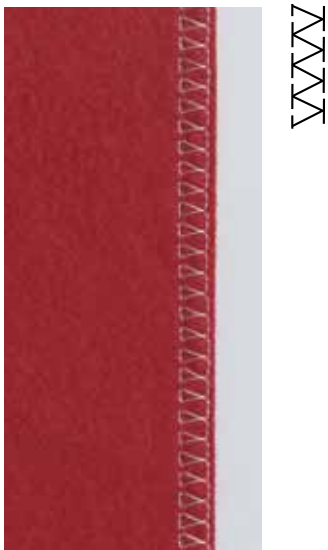

**Reverse pattern foot No. 1C**  
**Overlock foot No. 2A (optional accessory)**

**Double overlock No. 10**

### Closed seam

Double overlock seam in loose knits and cross seams in knits and jerseys.



#### Knits and jersey

- use a new Jersey needle to prevent damaging the loops
- if necessary loosen presser foot pressure

#### Sewing stretch materials

If necessary use a stretch needle (130/705H-S).

## Top stitching edges

**Blindstitch foot No. 5**  
**Reverse pattern foot No. 1C**  
**Edge stitch foot No. 10/10C/10D (optional accessory)**

### Straight stitch No. 1

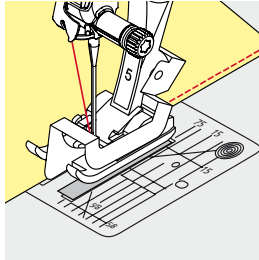

#### Narrow edgestitching

##### Outer edges

- place edge of fold left against the guide on the blindstitch foot
- select the needle position left in the desired distance to the edge

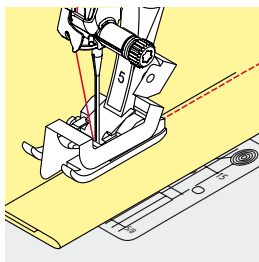

##### Hem edges

- place edge of fold (inside upper edge of hem) right against the guide on the blindstitch foot
- select needle position to the right to sew along the upper edge



**Blindstitch foot No. 5**  
 Needle position left or far right.

**Reverse pattern foot No. 1C and edge stitch foot No. 10/10C/10D (optional accessory)**  
 Any needle position possible.

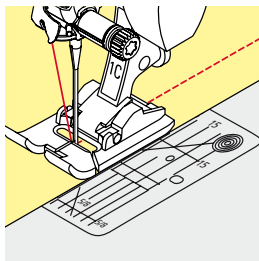

#### Wide edgestitching

##### Material guidance

Presser foot as guide:

- guide the folded edge along the edge of the presser foot

Stitch plate as guide:

- guide the folded edge along the marks on the stitch plate (1 to 2.5cm)

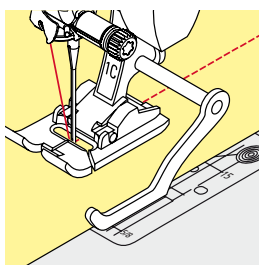

Seam guide as guide:

Presser foot

- loosen the screw on the back of the presser foot
- insert the seam guide into the hole of the presser foot
- adjust width as desired
- tighten the screw
- guide the folded edge along the seam guide

To sew parallel wider lines, guide the seam guide along a previously sewn line of stitches.

## Blind hem

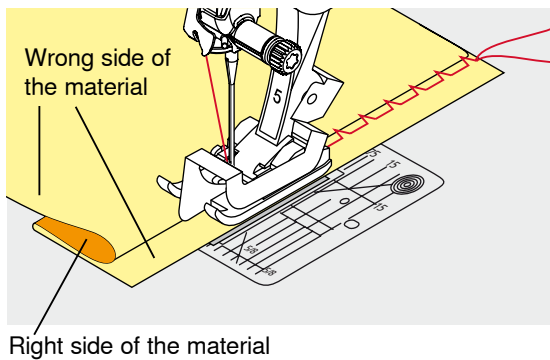
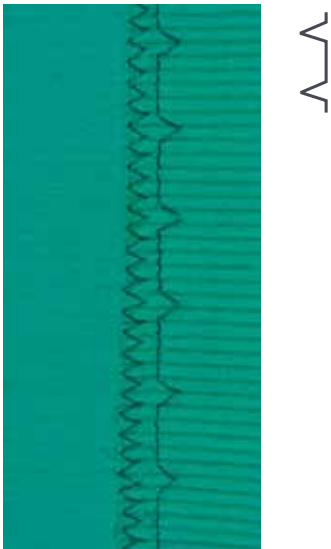

### Blindstitch foot No. 5

### Blindstitch No. 9

For invisible hems in medium to heavy weight cotton, wool and blended materials.

#### Preparation

- finish the raw edges
- fold the hem and baste or pin in place

- fold the fabric back over the right side of the fabric to expose the finished lower edge
- place under presser foot and
- move the folded edge against the metal guide on the presser foot

#### Sewing

The needle should just pierce the edge of the fold, as when hand blind-stitching.

- after sewing about 10cm, check both sides of fabric and adjust width again if necessary



#### Fine stitch width adjustment

Guide the folded edge evenly along the metal guide on the foot = even depth.

## Visible hem



### Reverse pattern foot No. 1C/1D

### Tricot stitch No. 14

For visible, elastic hems in jersey, cotton, synthetic and mixed fibers.

#### Preparation

- iron the hem, baste if necessary
- reduce the presser foot pressure if necessary

#### Sewing

- sew the hem at preferred depth on the right side
- trim excess fabric from the wrong side

## Securing program



**Reverse pattern foot No. 1C**

### Securing program No. 5

- for all fabrics
- secures beginning and end of seam

### Sewing long seams with straight stitch

Even securing by defined stitch count.

#### Beginning to sew

- press the foot control
- ▶ the sewing computer secures automatically when beginning to sew (5 stitches forward, 5 stitches in reverse)
- sew seam with straight stitches in desired length



#### Ending the seam

- press «Quick reverse»-button
- ▶ the sewing computer secures seam automatically (5 stitches in reverse, 5 stitches forward)
- ▶ the sewing computer stops automatically at the end of the securing program

## Basting stitch



**Reverse pattern foot No. 1C/1D**

### Basting stitch No. 21

- straight stitch, sews out every fourth stitch, i.e. longest stitch possible is 24mm, when the stitch length is set at 6mm. Recommended stitch length 3.5-5mm
- for work which requires a very long stitch
- basting seams, hems, Quilts etc.
- temporary joining
- easy to remove

#### Preparation

- pin work at a right angle to basting direction
- ▶ to prevent the layers from slipping



#### Securing/fixing the thread

Sew 3-4 securing stitches at the begin and at the end.

#### Thread

Use a fine darning thread for basting as it is easier to remove.

## Flat joining seam

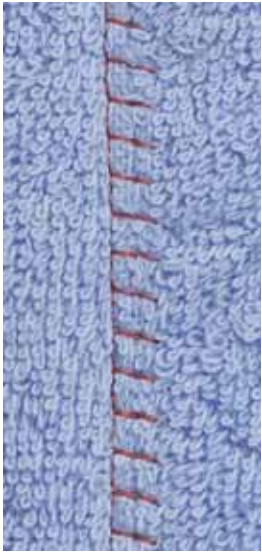

TTTTT

**Reverse pattern foot No. 1C**

**Stretch overlock No. 13**

Ideal for fluffy or thick materials such as terry cloth, felt and leather etc.

### **Sewing**

- overlap fabric edges
- sew along the fabric edge
- the needle should sew over the edge of the top layer on the right side
- ▶ very flat durable seam

## Height compensation of uneven layers

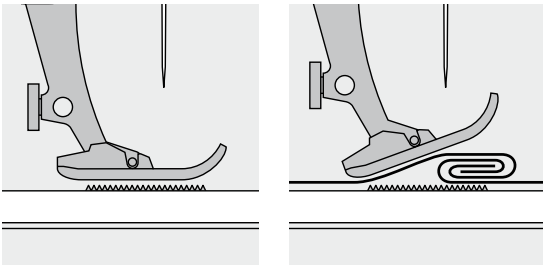

The feed dog works accurately when the foot is level.

If the foot is at an angle, e.g. when sewing over thick to thin or vice-versa, the feed dog cannot grip and feed the fabric. The fabric might jam.

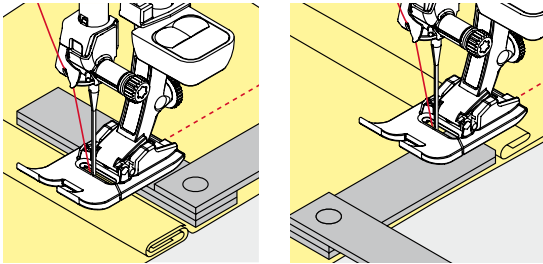

To solve this problem, place one, two or three compensating plates as required behind the needle under the presser foot to level it.

To correct the height in front of the foot, place one or more plates under the foot close to the needle. Sew until the foot is level again and remove the plates.



Needle stop down.

## Sewing corners

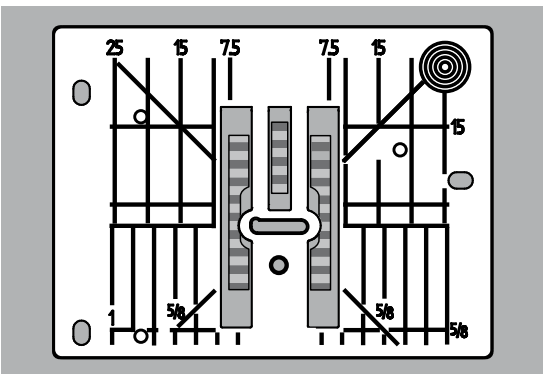

Due to the width of the stitch plate hole the outer feed dog rows are relatively far apart.

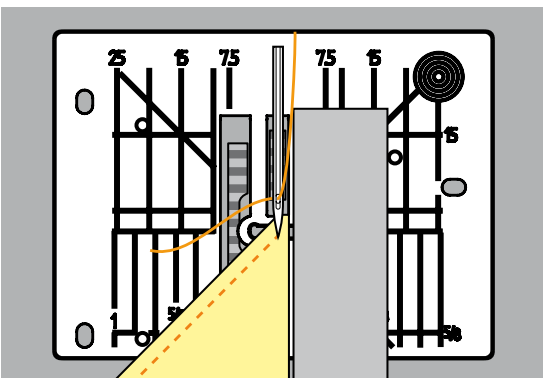

When sewing corners only a small section of the fabric is actually on the feed dog. Therefore it cannot grip the fabric well.

Place one or more plates of the height compensation tool parallel to the presser foot close to the edge of the fabric.

▶ the fabric is fed evenly



Needle stop down.



## Buttonholes

### Overview Buttonholes

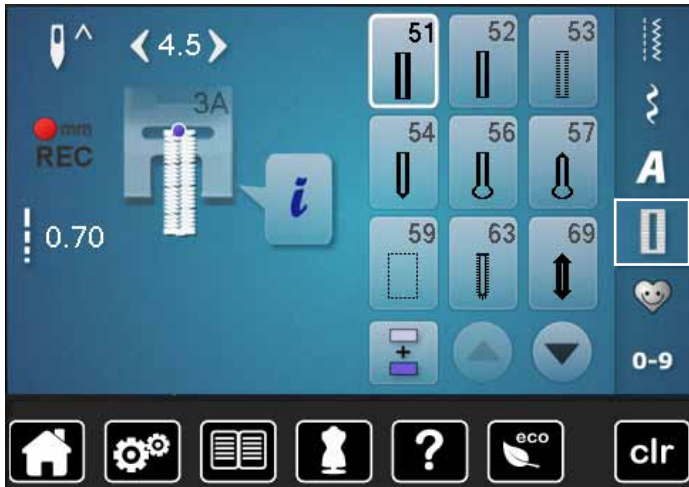

Buttonholes are not only practical closures, they can also be used as a decorative effect. All buttonholes can be programmed and sewn in different ways.

- touch «Buttonhole»-button
- scroll to see more buttonholes



**51 Standard buttonhole**  
For light to medium weight fabrics; blouses, shirts, trousers, bedlinens, etc.



**52 Narrow buttonhole**  
For light- to medium weight fabrics; blouses, dresses, children's and baby clothes, crafts



**53 Stretch buttonhole**  
For any highly elastic jersey made from cotton, wool, silk and synthetic fibers



**54 Round buttonhole with normal bartack**  
For medium- to heavy weight materials: dresses, jackets, coats, rainwear



**56 Keyhole buttonhole**  
For heavy weight, non-stretch materials; jackets, coats, leisure wear



**57 Keyhole Buttonhole with Pointed Bartack**  
For firmer, non-stretch materials: jackets, coats, leisure wear



**59 Straight-stitch buttonhole**  
Program for staystitching buttonholes, for pocket openings, reinforcing buttonholes; especially for buttonholes in leather and imitation leather



**60 Button sew-on program**  
For buttons with 2 and 4 holes



**61 Eyelet with small zig-zag**  
Openings for cords and narrow ribbons, decorative work



**62 Straight-stitch eyelet**  
Openings for cords and narrow ribbons, decorative work



**63 Heirloom buttonhole**  
For light- to medium weight woven fabrics; blouses, dresses, leisure wear, bed linen



**69 Decorative buttonhole with double pointed bartack**  
For decorative buttonholes in firmer, non-elastic fabrics

## Important information

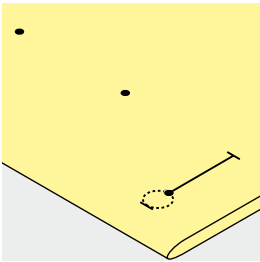
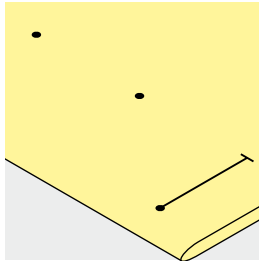
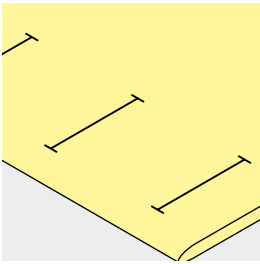

### Marking the length of manual buttonholes

- mark the buttonhole length in the desired position
- use buttonhole foot No. 3C (optional accessory)

### Marking the length of automatic buttonholes

- mark the length of just one buttonhole
- ▶ after sewing the first buttonhole the length is programmed
- mark only the beginning of all subsequent buttonholes
- use automatic buttonhole foot No. 3A

### Marking the length of keyhole buttonholes

- mark the bead length only
- ▶ the correct length eye will be added when the buttonhole is sewn
- ▶ after sewing the first buttonhole the length is programmed
- mark only the beginning of all subsequent buttonholes
- use automatic buttonhole foot No. 3A

### Test sewing

- always sew a test sample of the same fabric and stabilizer to be used for the project
- select the buttonhole type you intend to use
- sew the buttonhole in the same direction on the fabric (horizontal or vertical, with or against the grain)
- cut the buttonhole open
- push the button through the buttonhole
- adjust the buttonhole length if necessary

### To adjust the bead width

- alter the stitch width

### To adjust stitch length

Stitch length adjustments affect both buttonhole beads.

- ▶ spacing between the stitches

After stitch length adjustment:

- re-program the buttonhole



If a buttonhole is to be sewn at right angles to the seam, we recommend the use of the height compensation plates (optional accessory). Place the plates from the back between fabric and bottom of slide foot up to the thick part of the fabric and push to front.

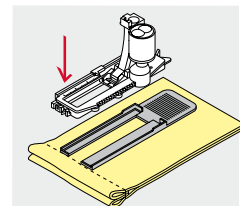

When sewing a buttonhole in difficult materials, we recommend using the Compensation plate for buttonholes (optional accessory). It can be used along with buttonhole foot No. 3A.

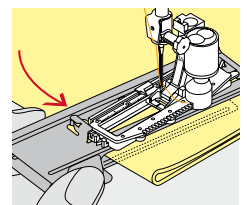

## Stabilizer



- interfacing provides durability and stability to the buttonhole
- choose the interfacing according to the material being used

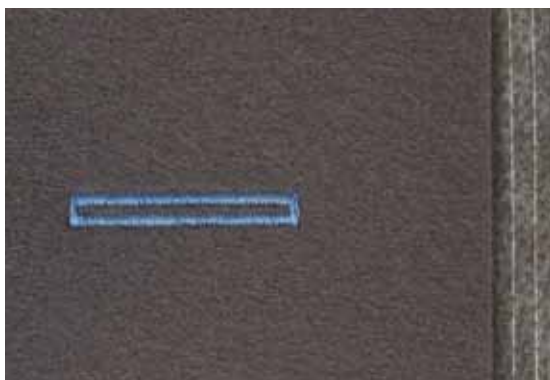

- when using thick or fluffy materials an embroidery stabilizer can be used
- ▶ therefore the fabric feeds better

## Cords



### Generally

- cords reinforce buttonholes and enhance their appearance
- mainly suitable for buttonhole No. 51
- position the work accordingly

### Ideal cords

- Perle cotton No. 8
- strong hand-sewing thread
- fine crochet yarn

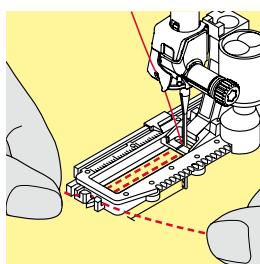
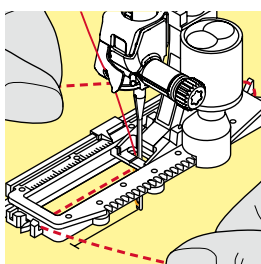

### Cord with the automatic buttonhole foot No. 3A

- raise the buttonhole foot No. 3A
- insert the needle at the beginning of the buttonhole
- guide the cord on the right side under the buttonhole foot No. 3A
- hook the cord over the pin at the back of the buttonhole foot No. 3A
- pull the cord on the left side under the buttonhole foot No. 3A to the front
- pull the cord ends into the slits
- lower the buttonhole foot No. 3A

### Sewing

- sew the buttonhole in the usual manner
- do **not** hold the cord
- the buttonhole will sew over the cord, covering it

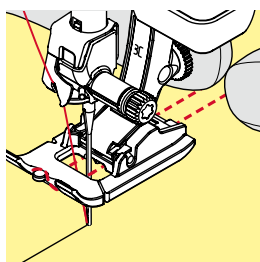
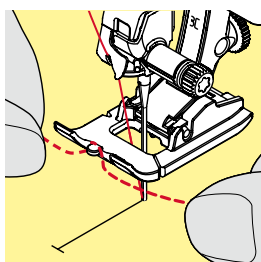

### Cord with the buttonhole foot No. 3C (optional accessory)

- raise the buttonhole foot
- insert the needle at the beginning of the buttonhole
- hook cord over the pin in the middle of the buttonhole foot (at the front)
- pull both cord ends under the buttonhole foot sole to the back and
- place both ends of the cord in the grooves on the sole
- lower the buttonhole foot

### Sewing

- sew the buttonhole in the usual manner
- do **not** hold the cord
- the buttonhole will sew over the cord, covering it

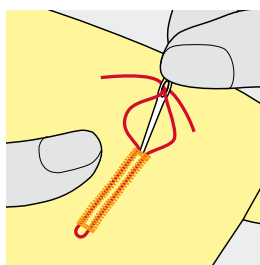

### Fixing the cord

- pull the cord through the buttonhole until the loop disappears into the end of it
- pull the ends of the cord through to wrong side of the fabric, using a hand stitching-needle
- knot or secure with stitches



### Before cutting the buttonhole open

Place a pin in each end of the buttonhole to prevent accidental cutting into ends of buttonhole.

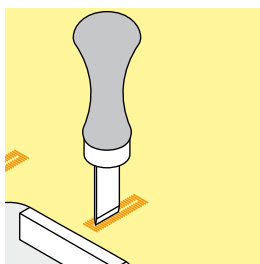
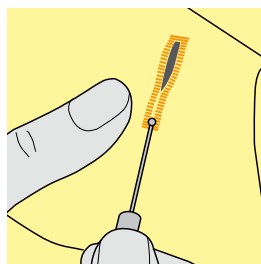

### Cutting buttonholes open with the seam ripper

- cut the buttonhole from the ends to the middle

### Cutting open buttonholes with the buttonhole cutter (optional accessory)

- place the fabric on the wood
- place the cutter in the centre of the buttonhole
- press down on the cutter with your hand

## Altering the balance



- touch «i»-icon
- touch «Balance»-icon

### Balance with direct entry length buttonholes

The balance alterations have the same effect on both beads.

### Balance with direct entry length keyhole or round buttonholes

The balance alterations have the same effect on both beads.

The keyhole or eye is balanced as follows:

- sew straight stitches forward until
- ▶ the sewing computer changes to the keyhole or eye, then
- stop the sewing computer
- touch the «Balance»-icon
- turn the stitch length-knob until the picture in the right portion of the Display is identical with the sewn buttonhole

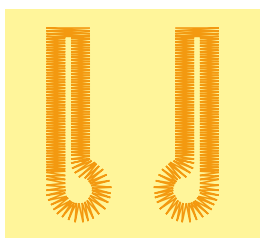

A B

The keyhole is distorted to the right **A**:

- turn stitch length knob to the left

The keyhole is distorted to the left **B**:

- turn the stitch length-knob to the right
- touch «Back»-icon and complete the buttonhole

### Balance for manual keyhole or round buttonhole

Any balance alteration affects both beads differently:

Left bead too dense **C**:

- turn the stitch length-knob to the left
- ▶ the left bead is elongated, the right bead is shortened

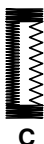

C

Left bead too wide **D**:

- turn stitch length-knob to the right
- ▶ the left bead is shortened, the right bead is elongated



D

The keyhole or eye is balanced as follows:

The keyhole is distorted to the right **A**:

- turn the stitch length knob to the right

The keyhole is distorted to the left **B**:

- turn the stitch length knob to the left

### Balance for manual standard buttonhole

The balance alterations have the same effect on both beads.

### Balance for stitch counter buttonhole

The balance has a different effect on both beads (see picture of the manual buttonhole).

- re-program the buttonhole after each alteration in balance

### Clear balance

- touch the yellow-framed icon in the special «Balance»-display or
- press the «clr»-button
- ▶ «clr» also deletes the programmed buttonhole!

### Recommendation

Test-sewing of the buttonhole on the original material.



In all Direct entry length and manual buttonholes each individual buttonhole sequence can be balanced separately. In stitch counter buttonholes the balance affects both beads differently (left and right): When altering the bead the keyhole or eye are automatically altered accordingly.

## Programming Buttonholes

### Standard and stretch buttonhole with auto-length, automatically



#### Buttonhole foot No. 3A

The lens on the automatic buttonhole foot No. 3A automatically registers the length of the buttonhole for exact duplication. For buttonholes of 4-31mm, depending on the buttonhole type.



The slide foot must lie perfectly flat on the fabric! If the slide foot rests on a seam allowance, the length cannot be measured accurately.

#### Automatic standard and stretch buttonhole No. 51, 52, 53

##### Programming the buttonhole

- 1
  - sew first bead forward
  - stop the sewing computer
  - press the «Quick reverse»-button
  - ▶ «auto» and the programmed length (in mm) appears in the Display
  - ▶ the buttonhole length is programmed

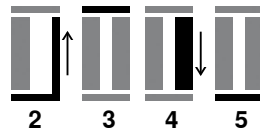

The sewing computer sews automatically:

- 2 the straight stitches in reverse
- 3 the first bartack
- 4 the second bead forwards
- 5 the second bartack and securing stitches
  - ▶ the sewing computer stops and returns automatically to buttonhole begin

##### Auto buttonhole

- ▶ all subsequent buttonholes will be sewn to exactly the same length (no need to press the «Quick reverse»-button)
- the programmed buttonholes can be saved in the long-term memory (see page 90)
- press the «clr»-button
- ▶ the programmed settings are cleared



##### Exact duplication

The auto function ensures that each buttonhole will be exactly the same length as the previous one.

##### Sewing speed

- sew at moderate speed for best results
- sew all buttonholes at the same speed for a consistent bead density

## Automatic with direct length entry

### Buttonhole foot No. 3A

#### Programming the buttonhole length

Buttonholes can be sewn to a specific length with the buttonhole foot No. 3A. Buttonhole length = cutting length in mm.



- select the desired buttonhole
- touch «i»-icon
- touch «Direct entry length»-icon

#### Determining buttonhole length

- enter the buttonhole length using the multifunction knobs (stitch width or stitch length knob)
  - ▶ the length entered appears on the left of the button
  - ▶ the number on the right of the button is the exact button size
- touch «Back»-icon
  - ▶ the length entered is saved
  - ▶ «auto» and the programmed length is shown on the left side in the Display

#### Back to the buttonhole menu

- touch «Back»-icon
  - ▶ the «Buttonhole»-display appears

## Automatic with button measuring

### Buttonhole foot No. 3A

#### Determining button size

The sewing computer calculates the length of the buttonhole directly from the diameter of the button. 2mm are automatically entered for the button thickness.

- hold the button on the bright field in the lower right corner of the Display
- adjust the bright field to the button size using the stitch width or stitch length knob
  - ▶ the button size is displayed in mm on the right of the button between the arrows (e.g. 14mm)
- remove the button from the Display
- touch «Back»-icon
  - ▶ the length entered is saved
  - ▶ «auto» and the programmed length is shown on the left side in the Display



#### Corrections for thick buttons

Match buttonhole length to buttonhole thickness (raised buttons, etc.) e.g. buttonhole length + 1cm (incl. 2mm) if button height is 1cm. The button slides easily through the buttonhole.



#### Back to buttonhole begin

- touch «Pattern begin»-icon
  - ▶ the sewing computer sets the program to the start of the buttonhole again



#### Deleting saved buttonholes

- press the «clr»-button or touch «recording»
  - ▶ «auto» goes off and «REC» appears
- a new buttonhole length can be programmed

## Automatic round and keyhole buttonhole



### Buttonhole foot No. 3A



The slide foot must lie perfectly flat on the fabric! If the slide foot rests on a seam allowance, the length cannot be measured accurately.

## Automatic round and keyhole buttonhole No. 54, 56, 57

### Programming buttonholes

- 1
  - sew straight stitches forward
  - stop the sewing computer
  - press «Quick reverse»-button
  - ▶ «auto» and the programmed length (in mm) appears in the Display
  - ▶ the buttonhole length is programmed

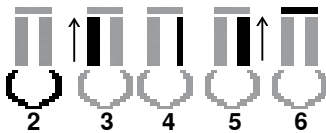
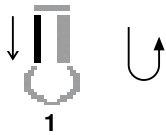

The sewing computer sews the following automatically:

- 2 the eye
- 3 the first bead in reverse
- 4 the straight stitches forward
- 5 the second bead in reverse
- 6 the bartack and securing stitches
  - ▶ the sewing computer stops and returns automatically to buttonhole begin

### Auto-buttonhole

- ▶ all subsequent buttonholes will be sewn to exactly the same length (no need to press the «Quick reverse»-button)
- the programmed buttonholes can be saved in the long-term memory (see page 90)
- press «clr»-button
- ▶ the programmed settings are cleared



### Exact duplication

The auto function ensures that each buttonhole will be exactly the same length as the previous one.

### Double sewn keyhole buttonholes

- keyhole buttonholes can be sewn twice on thick fabrics - use a longer stitch length for the first run
- after sewing the first buttonhole, do not move the work
- reduce the stitch length manually and sew the buttonhole again



### Decorative buttonhole with double pointed bartack No. 69



1

#### Programming the buttonhole

- 1
  - sew the first bead forward
  - stop the sewing computer
  - press «Quick reverse»-button
  - ▶ «auto» and the programmed length (in mm) appears in the Display
  - ▶ the buttonhole length is programmed

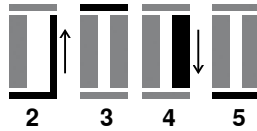

2

3

4

5

#### The sewing computer sews automatically:

- 2 straight stitches in reverse
- 3 the upper bartack
- 4 the second bead forward
- 5 the lower bartack and the securing stitches
  - ▶ the sewing computer stops and returns automatically to buttonhole begin

#### Auto buttonhole

- ▶ all subsequent buttonholes will be sewn to exactly the same length (no need to press «Quick reverse»-button)
- the programmed buttonholes can be saved in the long-term memory (see page 90)
- press the «clr»-button
- ▶ the programmed settings are cleared

## Heirloom Buttonhole

### Buttonhole foot No. 3A

### Heirloom buttonhole No. 63

#### Programming the buttonhole

- 1
  - sew first bead forward
  - stop the sewing computer
  - press «Quick reverse»-button
    - ▶ «auto» and the programmed length (in mm) appears in the Display
    - ▶ the buttonhole length is programmed

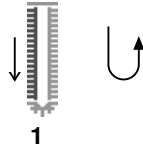

The sewing computer sews the following automatically:

- 2 the round part
- 3 the second bead in reverse
  - ▶ the sewing computer stops and returns automatically to buttonhole begin
- 4 the bartack and the securing stitches

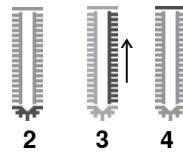

#### Auto buttonhole

- ▶ all subsequent buttonholes will be sewn to exactly the same length (no need to press the «Quick reverse»-button)
- the programmed buttonholes can be saved in the long-term memory (see page 90)
- press «clr»-button
  - ▶ the programmed settings are cleared

## Stitch counter buttonhole



- touch «i»-icon
- touch «REC»-icon

### Buttonhole foot No. 3C (optional accessory)

#### All buttonhole types

#### Programming the buttonhole

- 1
  - sew first bead forward
  - stop the sewing computer
  - press «Quick reverse»-button



- 2 sew lower bartack and
- 3 sew second bead in reverse
  - stop the sewing at the first stitch
  - press «Quick reverse»-button
- 4 the sewing computer sews the upper bartack, the securing stitches and stops automatically
  - ▶ «auto» appear in the Display
  - ▶ the buttonhole length is programmed
  - ▶ each subsequent buttonhole the programmed number of stitches are sewn

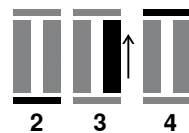

– the first bead (left) is sewn forwards, the second bead (right) is sewn in reverse

## Buttonhole in long term memory



- touch «Memory»-button



### Programming the buttonhole

- touch «Save»-icon 1
- ▶ the «Save»-display appears
- touch «Save»-icon
- ▶ the buttonhole is now saved in long term memory



- touch «Memory»-button

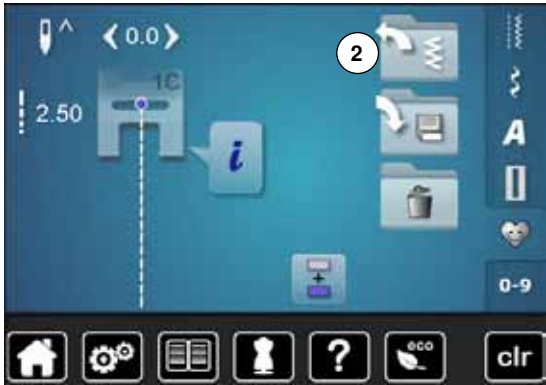

### Selecting a saved buttonhole

- touch folder 2



- select buttonhole



**Altering saved buttonhole**

- touch «i»-icon
- touch «Direct entry length»-icon
- alter the length of the saved buttonhole
- touch «Back»-icon twice
- reprogram the buttonhole as described



- touch «Memory»-button



**Deleting a saved buttonhole**

- touch «Delete»-icon 1
- ▶ the saved buttonholes appear
- select desired buttonhole
- confirm with ✓
- ▶ the buttonhole is deleted

## 7- or 5-step-buttonhole, manually



### Buttonhole foot No. 3C (optional accessory)

- select the desired buttonhole
- touch «i»-icon
- touch «man»-icon

The length of the beads is manually determined when sewing. Bartack, eye and securing stitches are pre-programmed. The individual steps can also be selected by scrolling, by using the arrow icons or by touching the «Quick reverse»-button.



### Sewing 7-Step buttonhole

- ▶ step 1 is activated for buttonhole begin
- ▶ step 2 is activated when beginning to sew
- sew first bead
- stop the sewing computer at desired length of the bead or to the end of the length marking
- select step 3
- ▶ sewing computer sews straight stitches in reverse
- stop sewing computer at the height of the first stitch (buttonhole begin)
- select step 4
- ▶ the sewing computer sews top bartack and stops automatically
- select step 5
- ▶ the sewing computer sews the second bead
- stop the sewing computer at the height of the first bead
- select step 6
- ▶ the sewing computer sews bottom bartack and stops automatically
- select step 7
- ▶ sewing computer secures stitches and stops automatically



### Sewing 5-Step buttonhole

- ▶ step 1 is activated for buttonhole begin
- ▶ step 2 is activated when beginning to sew
- sew first bead
- stop the sewing computer at desired length of the bead or at the end of the length marking
- select step 3
- ▶ the sewing computer sews the eye or the keyhole and stops automatically
- select step 4
- ▶ the sewing computer sews the second bead in reverse
- stop the sewing computer at the height of the first stitch (buttonhole begin)
- select step 5
- ▶ sewing computer sews the top bartack and secures stitches automatically



### Straight stitch buttonhole No. 59

- The same programming procedure as with the auto buttonhole program (see page 85)
- Buttonholes No. 59 with the straight stitch is recommended for soft, loosely woven fabrics and for buttonholes that will receive excessive wear. The straight stitch buttonholes also reinforce, vinyl and felt

## Button sew-on program



- touch «Buttonhole«-button
- touch «Button sew-on program»-icon

**Darning foot No. 9 (optional accessory)**  
**Button sew-on foot No. 18 (optional accessory)**

### Button sew-on program No. 60

For buttons with 2 and 4 holes.

#### Preparation

- lower the feed dog

#### Sewing on Buttons

Buttons sewn on for decorative purposes only are stitched without a thread shank. «Shank length» = distance between button and fabric; can be adjusted with Button sew-on foot No. 18.

#### Sewing on buttons with darning foot No. 9 (optional accessory)

- select button sew-on program
- check distances between holes with the handwheel
- adjust stitch width if necessary
- hold the threads when starting to sew
- sew the first securing stitches into the left hole
- sew program
- ▶ sewing computer stops automatically when program is completed and is ready for the next button

#### Beginning and ending threads

The threads are secured and can be trimmed.

#### For a increased stability

- pull on both bobbin threads until the ends of the upper threads are visible on the wrong side
- pull the threads out and knot the ends additionally
- trim the threads

#### Sewing on buttons with foot No. 18 (optional accessory)

- set the shank length with the screw on the foot
- select button sewing-on program and continue as with foot No. 9 (optional accessory)

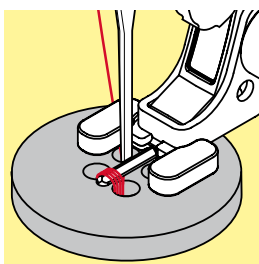
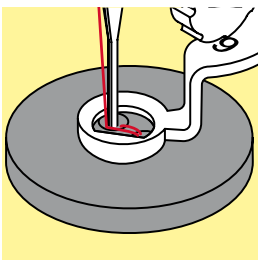

#### Sewing on a 4-Hole button

- sew the front holes first
- carefully move the button forward
- sew the back holes with the same program



For a increased stability the button sew-on program can be sewn twice.

## Eyelet program



- touch «Buttonhole»-button
- touch «Eyelet program»-icon

**Reverse pattern foot No. 1C**  
**Open embroidery foot No. 20C**

**Eyelet with small zig-zag No. 61**  
**Straight stitch eyelet No. 62**



### Sewing eyelets

- select eyelet
- position fabric under the presser foot and sew eyelet program
- ▶ sewing computer stops automatically and is at the beginning of the eyelet program again

### Punching eyelets

- use an awl, punch pliers or a hole punch to open the eyelet



Adjust the roundness of the eyelet if necessary with balance.  
For increased stability sew the eyelet twice.

## Decorative stitches

### Overview Decorative stitches

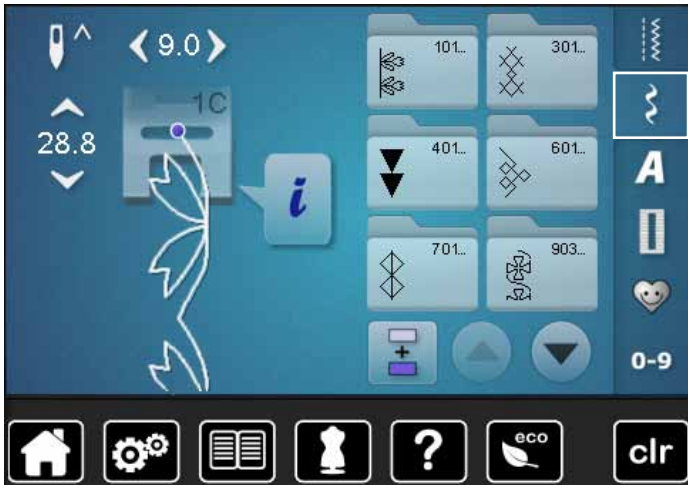

- touch «Decorative stitches»-button
- ▶ display shows an overview of the categories
- select the desired category
- ▶ the desired category is activated
- select the desired stitch pattern

### Application

Depending on the type of material, simple or more complex decorative stitches should be selected to best suit the material.

- decorative stitches which are programmed with simple straight stitches, are particularly appropriate for light weight materials, e.g. decorative stitch No. 101
- decorative stitches which are programmed with triple straight stitches or with a few satin stitches are particularly appropriate for medium weight materials, e.g. decorative stitch No. 107
- decorative stitches which are programmed with satin stitches are particularly appropriate for medium weight materials, e.g. decorative stitch No. 401



#### Categories

- Cat. 100 = Florals
- Cat. 300 = Cross stitches
- Cat. 400 = Satin stitches
- Cat. 600 = Ornamental stitches
- Cat. 700 = Heirloom stitches
- Cat. 900 = Novelty
- Cat. 1300 = Quilt stitches



#### Perfect stitch formation

- use the same thread color for upper and lower thread
- reinforce the fabric on the wrong side using stabilizer
- use an additional, water-soluble stabilizer on the right side of pile or longfiber materials (e.g. wool, velvet etc.) which can be easily removed after sewing



## Examples of application Decorative stitches

### Cross Stitches

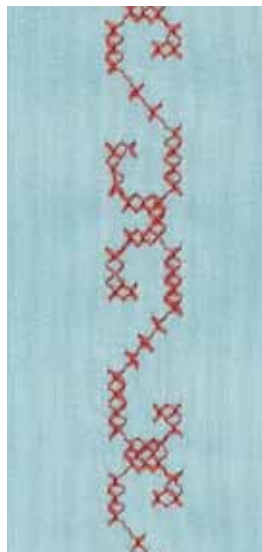

**Reverse pattern foot No. 1C/1D or  
Open embroidery foot No. 20C or 20D (optional accessory)**

#### Cross stitch

- cross stitching is a traditional technique, and extends the range of decorative stitches
- if the cross stitches are sewn on fabric with a linen texture, they look like hand-stitched cross stitching

#### Application

- for home furnishings
- for trimmings on garments
- for embellishing in general

#### Sewing

Cross stitches of Category 300 can be stitched and combined like any other decorative stitches.

#### Sewing Trims

- select cross stitch
- stitch a row, using the seam guide or slide-on table seam guide (optional accessory)

It is important to stitch the first row in a straight line, as it will serve as a reference for the rows that follow.

- select new stitch pattern
- stitch a second row next to first at a distance of one presser foot's width, or using the seam guide
- repeat for the following rows of stitching



**Use cotton embroidery thread for cross stitching**  
Stitch appears fuller.

## Pintucks



### Pintuck feet (optional accessory)

- No. 30 (3 grooves) = 4mm double needle: for heavy weight materials
- No. 31 (5 grooves) = 3mm double needle: for heavy to medium weight materials
- No. 32 (7 grooves) = 2mm double needle: for light to medium weight materials
- No. 33 (9 grooves) = 1 or 1.6mm double needle: for very light materials (without additional pintuck cord)
- No. 46C (5 grooves) = 1.6-2.5 mm double needle: for very light to medium weight materials

### Straight stitch No. 1

- this technique reduces the size of the fabric (allow for enough fabric)
- pintucks are narrow stitched folds which are normally sewn on the fabric before cutting out the pieces for garments or other sewing projects
- for embellishing or in combination with other heirloom embroidery techniques

### Corded pintucks

- pintucks may be sewn with or without cord
- cord pintucks for a raised effect and texture
- chose a cord that fits well into the grooves of the selected pintuck foot
- the cord must be colorfast and shrinkproof

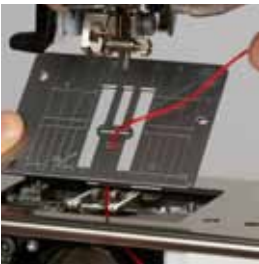

### Inserting the cord

- remove the stitch plate of the sewing computer (see page 25)
- open the bobbin door
- pull the cord through the hook opening from the bottom and through the opening of the stitch plate
- replace the stitch plate
- close the bobbin cover
- make sure that the cord slides within the thread slot of the bobbin cover
- place the cord spool on the arm of the Free Hand System
- check that the cord runs smoothly

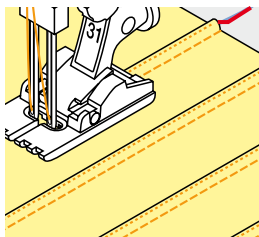

### Sewing pintucks

- sew first pintuck, marking the stitching line if necessary
  - ▶ the cord will automatically feed into the pintuck
- The cord lies on the wrong side of the material and is hold/sewn over by the lower thread.
- turn work if necessary
  - place first pintuck in one of the side grooves in the presser foot (depending on the desired distance)
  - sew second pintuck
  - sew additional pintucks parallel to these two



If the thread doesn't slide smoothly past the bobbin cover, open the cover while sewing and turn off the lower thread indicator in the Setup Program.

## Bobbin-Play sewing



### ATTENTION!

For this application an accessory bobbin case is required.

#### Free motion sewing

The bobbin can be filled different thread material. For free-motion stitching to add texture. This method is similar to «normal» free-motion sewing, but is done on the **wrong side** of the fabric.

Reinforce the area to be sewn with embroidery stabilizer. The design can be drawn on the wrong side of the fabric. You can also draw the design on the front of the fabric, then follow the lines with a freely guided straight stitch and polyester, cotton or rayon thread. The rows of stitching are visible on the right side of the fabric, and serve as reference lines for the bobbin-thread sewing.

The BSR function can be used for bobbin-thread sewing. Guide your project at uniform speed evenly under the needle, follow the lines of the design. Remove the stabilizer after you finish sewing.

Sew a sample first to check what the result looks like on the wrong side of the fabric. Alter the upper thread tension if required.

#### Sewing decorative stitches

Not all decorative stitches are suitable for this technique. Simple decorative stitches provide best results. Avoid compact stitch types and satin stitches.

The Open Embroidery foot No. 20 or No. 20D (optional accessory) is ideal for this technique.

- adjust stitch length and width settings (widen, lengthen) so that nice results are also achieved when sewing with thicker threads
- the long stitch function produces another decorative effect
- alter the upper thread tension if required

## Quilt stitches

### Overview Quilt stitches



Various stitch patterns are available which are used especially in quilting, for patchwork or for appliqué.

- touch «Decorative stitch»-button
- ▶ display shows an overview of the categories
- Cat. 1300 = Quilt stitches
- select desired stitch pattern
- ▶ the stitch width cannot be altered with certain stitch patterns
- ▶ is indicated by a lock symbol



1324 Quilters' securing program



1329 Blanket stitch



1339 Decorative quilt stitches variations  
1339-1345, 1351, 1355-1356, 1359



1325 Quilting straight stitch



1330 Double blanket stitch

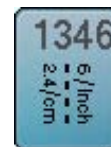

1346 Quilt stitch/Handlook quilt stitch variations  
1346-1348, 1350



1326 Piecing stitch/Straight stitch



1331 Blind stitch (narrow)



1352 Blanket stitch (dual)



1327 Stippling stitch



1332 Feather stitch



1353 Double blanket stitch (dual)



1328 Handlook quilt stitch



1333 Feather stitch variations  
1333-1338



1354 Satin stitch

## Examples of application Quilt stitches

### Handlook quilt stitch

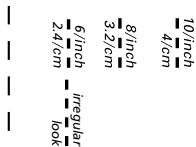

10/inch  
4/cm  
8/inch  
3.2/cm  
6/inch  
2.4/cm  
irregular  
look

**Reverse pattern foot No. 1C**

**Handlook quilt stitch No. 1328, 1346, 1347, 1348, 1350**

Suitable for all fabrics and work which should look «hand sewn».

#### Thread

- Upper thread = Monofilament
- Lower thread = 30/2 cotton thread

#### Test-sewing

- ▶ the lower thread is pulled up by strong upper thread tension
- **one** stitch is visible (bobbin thread)
- **one** stitch invisible (monofilament) = hand-look effect

#### Upper thread tension

Depending on the fabric increase the tension (6-9).

#### Balance

Adjust stitch with the balance if necessary.



#### Perfect corners

- press «Needle stop»-button, needle down, press «Pattern end/pattern repeat»-button, turn fabric
- when pivoting make sure that the fabric does not become distorted

#### Monofilament breaks

- sew more slowly
- reduce upper thread tension slightly

## For free-motion quilting

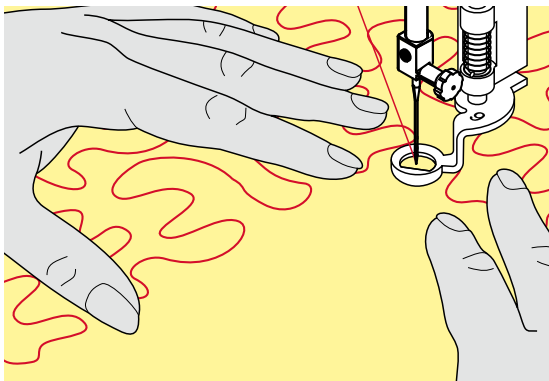
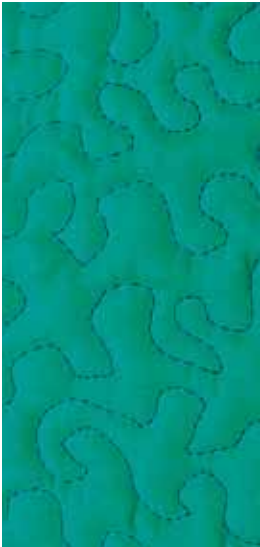

**Darning foot No. 9 (optional accessory)**

**Straight stitch No. 1**

**For free-motion quilting**

For all types of free motion quilting work.

**Preparation**

- pin top layer, batting and backing together, or baste if necessary
- attach slide-on table
- use the Free Hand System
- lower the feed dog

**Holding the work**

- hold the work with both hands like an embroidery frame, close to the presser foot



Quilt gloves with rubber fingertips will help when guiding the work.

**Quilting a design**

- quilt from the center outwards
- guide the work using smooth, round movements to form the design of your choice

**Stipple quilting**

- this technique covers the entire surface of the fabric with quilt stitches
- the lines of stitching are rounded and never cross one another



**Free-motion quilting and darning**

The two techniques are based on the same Free Motion principles.

**Poor stitch formation**

- if thread is lying on top of the fabric, slow down the movement of the material
- if there are knots on the wrong side of the fabric, move the material more quickly

**Monofilament breaks**

Reduce the motor speed and/or loosen the upper thread tension.

**Thread breaks**

Guide the fabric more consistently.

## BSR (BERNINA Stitch Regulator)

### Quilting with BSR



#### BSR-Function

The BSR presser foot reacts to the movement of the fabric under the foot and controls the speed of the sewing computer up to the maximum speed possible. The following applies: the faster the fabric is moved, the higher the speed of the sewing computer.

If the fabric is moved too fast, an acoustic signal (beep sound) is heard, if the Beeper is activated (see page 105).

#### ATTENTION!

**As long as the BSR presser foot is illuminated red, adjustments like threading and changing the needle, for example, must not be carried out, as the needle will engage while fabric is moved unintentionally! Without fabric feed the BSR mode is turned off after approx. 7 seconds and the red light goes off (mode 1).**

**Please refer to Safety Instructions!**

**By activating the BSR function the sewing computer sews either continuously at reduced speed (mode 1, standard), or as soon as the fabric is moved (mode 2).**

#### BSR function with straight stitch No. 1

This function using the BSR presser foot, allows for free-motion quilting (sewing) using the straight stitch and a pre-selected stitch length up to 4mm. The regulated set stitch length is maintained within a certain speed, independent of the movement of the fabric.

#### BSR function with zig-zag No. 2

The zig-zag can be used e.g. for thread painting. The set stitch length will **not** be maintained when sewing with the zigzag stitch, but the BSR function simplifies the application.

#### There are:

##### Two different BSR modes

- **BSR 1-Mode** is the active standard
- the sewing computer runs continuously at a reduced motor speed, as soon as the foot control or the «Start/Stop»-button is pressed
- the speed of the sewing computer is regulated by the movement of the fabric
- through continuous needle movement, securing in the same position is possible without pressing an additional button
- **BSR 2-Mode** is activated by selecting the «BSR 2»-icon in the «BSR»-display
- the sewing computer will only engage if the foot control or the «Start/Stop»-button is pressed and the fabric is moved simultaneously
- the speed of the sewing computer is regulated by the movement of the fabric
- to secure press the «Securing function»-button
- by selecting the «BSR 1»-icon in the «BSR»-display Mode 1 is activated



For an even sewing start (the first stitch) the foot control must be pressed and the fabric moved simultaneously. This also applies for sewing points and straight stitching within a round form.

If the BSR function is deactivated and later re-activated without the sewing computer being switched off in between, the last selected BSR mode is active.

When exceeding a certain speed, adhering to regular stitch length cannot be guaranteed.

Make sure that the lens on the bottom of the BSR foot is clean (no fingerprints, etc.). Clean lens periodically with soft, slightly damp cloth.

### Preparation

- lower the feed dog
- presser foot pressure may be reduced depending on the material type and thickness
- attach slide-on table
- use the Free Hand System

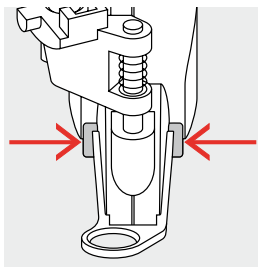

### Remove presser foot sole

- press both buttons together
- slide the sole downwards out of the groove

### Attaching the presser foot sole

- slide the desired sole up in the groove until it clicks into its place

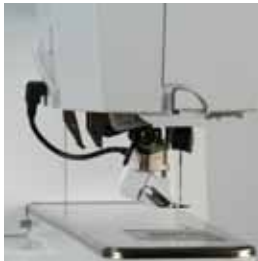

- attach the BSR Presser Foot to the sewing computer
- plug the cable in the outlet 1 provided

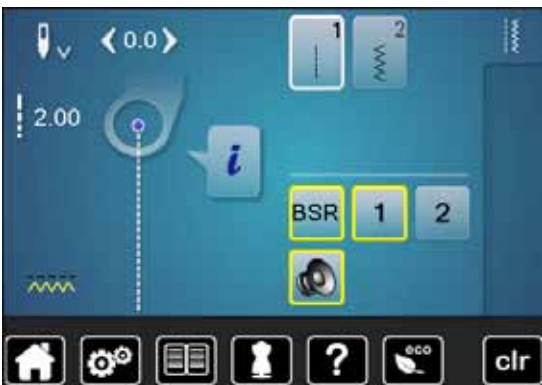

- ▶ «BSR»-display is opened automatically
- ▶ BSR 1 mode is engaged
- set the desired stitch length
  - the standard stitch length is 2mm
  - when sewing small forms and stippings, stitch length of 1-1.5mm is suggested



## Functions in the BSR mode

### Needle stop down (standard)

- ▶ the arrow points down on the «BSR»-display
- ▶ the sewing computer stops with needle down, when taking foot off foot control or when the «Start/Stop»-button is pressed

### Needle stop up

- touch the «Needle stop»-icon in the Display
- ▶ the arrow points up
- ▶ the sewing computer stops with needle up, when taking foot off foot control or when the «Start/Stop»-button is pressed

### Raise or lower the needle

- press «Needle stop»-button
- ▶ to raise or to lower the needle

### Securing with the «Start/Stop»-button (only Mode 1)

- place the fabric under the presser foot
- lower the presser foot
- press the «Needle stop»-button twice
- ▶ the lower thread is brought up
- hold upper and lower thread
- touch «Start/Stop»-button
- ▶ BSR mode is activated
- sew 5-6 securing stitches
- touch «Start/Stop»-button
- ▶ the BSR mode is stopped
- cut threads
- touch «Start/Stop»-button
- ▶ BSR mode is activated
- continue the stitching process

### Securing function (only Mode 2)

- press the «Securing function»-button
  - press either the foot control or the «Start/Stop»-button
- By moving the fabric some short securing stitches are sewn, then the set stitch length will be activated and the securing function will be automatically deactivated.

### Free motion quilting (only Mode 2)

- ▶ the BSR mode is activated
- freemotion quilting can be sewn
- by touching the securing function button is pressed during free hand quilting, a short securing stitch sequence is sewn and
- ▶ the sewing computer stops
- ▶ the BSR mode is deactivated

### Free motion quilting without BSR activation

- touch «BSR»-icon
  - the BSR mode is deactivated
- Normal freemotion quilting can now be sewn with the BSR foot, without automatic regular stitch length.



### Beeper (audio signal) activation/deactivation

- touch «Setup»-button
- touch «Audio setting»-icon



### Selecting sound for BSR in the Setup Program

- ▶ one sound is set as default (active)
- touch the icon 1 showing the loudspeaker for BSR
- ▶ the loudspeaker is highlighted in red
- ▶ the sound for the beeper is inactive

The loudspeaker is gray when the sound for the Beeper is active.

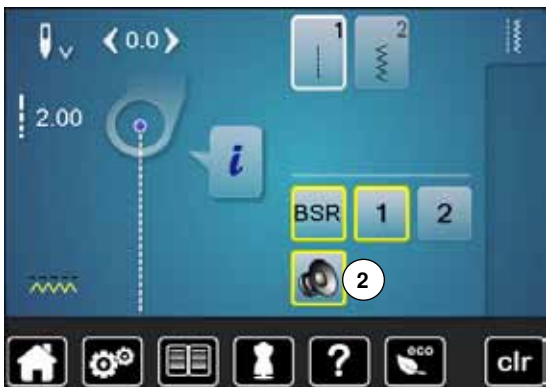

### Selecting sound for BSR in the «BSR»-display

- touch the icon with the loudspeaker
- ▶ the loudspeaker is highlighted in red
- ▶ the sound for the beeper is inactive

The icon with the loudspeaker is gray and yellow-framed when the sound for the Beeper is active.



The sound selection icon 2 is only visible if the sounds are turned on in the Setup Program.

## Activating the BSR Sewing Function

### 1. Option:

BSR-Function via the foot control

- plug in the foot control
- press the foot control
- ▶ presser foot is lowered
- press the foot control again
- ▶ BSR mode starts
- ▶ a red light appears on the presser foot
- press foot control while sewing
- the speed of the sewing computer is regulated by the movement of the fabric
- release the foot control
- ▶ the BSR mode is stopped

### 2. Option:

BSR-Function via the «Start/Stop»-button

- touch «Start/Stop»-button
- ▶ presser foot is lowered
- press «Start/Stop»-button again
- ▶ BSR mode starts
- ▶ a red light appears on the presser foot
- the speed of the sewing computer is regulated by the movement of the fabric
- press the «Start/Stop»-button again
- ▶ the BSR mode is stopped

## Deactivating the BSR Sewing Function by using the «Start/Stop»-button Mode 1

If the fabric is not moved for approx. 7 seconds, the BSR mode is deactivated and the red light on the presser foot goes off.

### Mode 2

If the stitching process is ended by no longer moving the fabric, **one** additional stitch is made, depending on the needle position. The sewing computer always stops with needle up, even if the arrow on the «BSR»-Display points down.



### Holding the work

- hold the work with both hands like an embroidery frame, close to the presser foot
- abrupt movements (slowing down resp. speeding up) can result in slightly too short or too long stitches
- continuous movement (no abrupt movements) will provide best results
- do not pivot the fabric while sewing



Quilt gloves with rubber fingertips will help when guiding the work.



### Application example:

- BSR with zig-zag No. 2
- the zig-zag can be used for thread painting
- areas can be filled and therefore forms or pictures can be created

### BSR Function deactivation

- pull out the plug of the BSR presser foot connection cable on the sewing computer
- remove the BSR foot

## BERNINA Dual Feed

### ATTENTION!

Only use «D» presser feet with cut-out at the center back.  
If an incorrect presser foot is attached, the sewing computer will not start with the dual feed engaged. An error message will appear.

With the BERNINA Dual Feed the top and bottom layer of fabric are fed simultaneously, the even feeding enables perfect matching of striped and checkered patterns.

#### Presser Feet Selection

- Reverse pattern foot 1D
- Zipper foot 4D



More «D» presser feet are listed in the enclosed accessories catalogue.



#### Switching On BERNINA Dual Feed

- raise the presser foot
- pull dual feed down until it engages



#### Switching Off BERNINA Dual Feed

- raise the presser foot
- hold dual feed on holder with two fingers, pull it down,
- then push backward, slowly letting it slide upward

## Fabrics

### Difficult-to-work-with fabrics (with a nap, slippery, sticky etc.):

- velvet, normally sewn with the grain
  - towelling
  - Jersey, especially when sewing it crosswise to knit
  - fake fur or coated fake fur
  - fleece-types of fabrics
  - batted fabrics
  - stripes and checks
  - curtain fabrics with pattern repeats
- «Sticky» Fabrics:
- imitation leather, coated fabrics (Dual Feed presser foot with sliding sole)

### Application

#### Sewing:

- all sewing techniques on difficult fabrics, e.g. hems, zippers

#### Patchwork:

- accurate stripes and blocks
- decorative stitches up to 9mm stitch width

#### Appliqués:

- open embroidery foot 20D (optional accessory)
- sewing on ribbons and bias-binding



#### Presser foot pressure

Adjust the presser foot pressure to the fabric. The thicker the fabric the lower the presser foot pressure.

## Alphabets

### Overview Alphabet

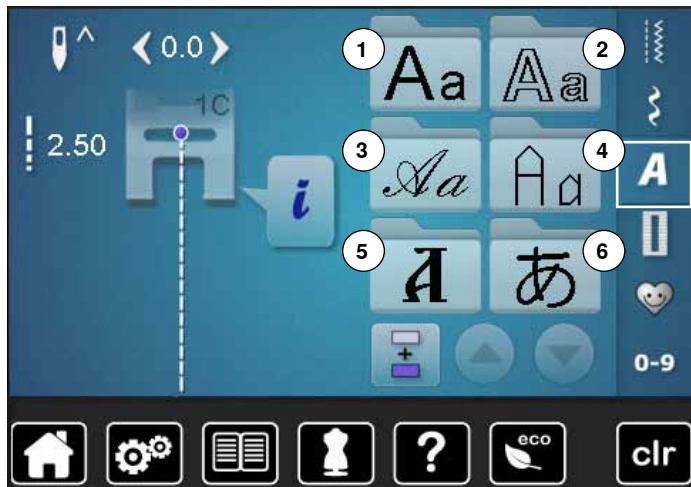

Block-, Double Block-, Script and Quilt Text alphabet and Cyrillic can be sewn in two different sizes.  
 Block-, Double Block-, Script-, Quilt Text alphabet and Cyrillic can also be sewn in lower case.  
 Numbers and special characters are located at the end of the upper case.

- touch «Alphabet»-button
  - ▶ the Display shows the overview with the different alphabet types
- 1 Block alphabet
  - 2 Double Block
  - 3 Script (Italics)
  - 4 Quilting Text
  - 5 Cyrillic
  - 6 Hiragana
- select desired alphabet



### Lettering

- all capital letters, numbers, punctuation marks and special characters can be viewed using the arrow icons

### Perfect stitch formation

- use the same thread color for upper and lower threads
- reinforce the fabric with embroidery stabilizer on the wrong side
- use an additional, water-soluble stabilizer on the right side of pile or napped fabrics (e.g. wool, velvet etc.)
- for lightweight fabrics more simple lettering types programmed with straight stitches are suitable (such as double block letters)

## Combining lettering

Individual letters and rows of the same letter of the same alphabet are sewn in single mode.

Letters for names, addresses, words, etc. are combined and sewn in combi mode.



- touch «Combi mode»-icon
- touch the icon with the desired letter
- ▶ the letter appears in the Stitch altering area
- ▶ the cursor is below the letter



### Selecting the next letter

- touch the required icon
- ▶ the next letter appears in the Stitch altering area etc.

## Correcting the combination



### Inserting lettering

A letter is always inserted above the cursor.

Inserting an additional letter at the beginning of a pattern combination:

- move the cursor up by using the arrow icons
- Activating desired place:
  - select or scroll to required letter in the Stitch altering area
  - select new letter
  - ▶ letter is inserted above cursor

### Deleting Letters

A letter is always deleted above the cursor.

Activating desired place:

- select or scroll to the required letter in the Stitch altering area
- touch «Delete»-icon
- ▶ letter is deleted

Saving and deleting combinations see page 116, 120.

## Alphabet in combination with functions



### Select lower case

- touch the «Upper/Lower case»-icon
  - ▶ the lower case «a» is highlighted in black and jumps to the upper left corner of the icon
  - ▶ the lower case is activated
- touch the «Upper/Lower case»-icon again
  - ▶ the upper case «A» is highlighted in black and jumps to the upper left corner of the icon
  - ▶ upper case is activated again



### Change size

- touch «i»-icon
- touch «Lettering size»-icon
  - ▶ the icon with the number **2** turns blue
  - ▶ the font size is reduced
- touch the «Lettering size»-icon again
  - ▶ larger size is activated again (number 1 is highlighted in blue)



## Personal program

### Creating a Personal Display

Use the Personal program to create a file with stitches you use most for a special project. Stitch patterns as well as their alterations are saved in the Personal program.



The following alterations can be saved:

- Stitch width
- Stitch length
- Needle position
- Thread tension
- Mirror image
- Pattern extend
- Long stitch
- Balance
- Pattern repeat 1-9x

If the memory has already been filled with embroidery motifs and stitch pattern combinations, no further stitch patterns can be saved in the Personal program. An appropriate message appears. The content in the memory must first be deleted to ensure there is sufficient free space.

### Preparing stitch patterns



#### Programming/Saving first stitch pattern

- select e.g. the zig-zag in the «Practical stitch»-display
- make alterations

- 1 • touch «Personal program»-button 1



- touch «Save»-icon 2

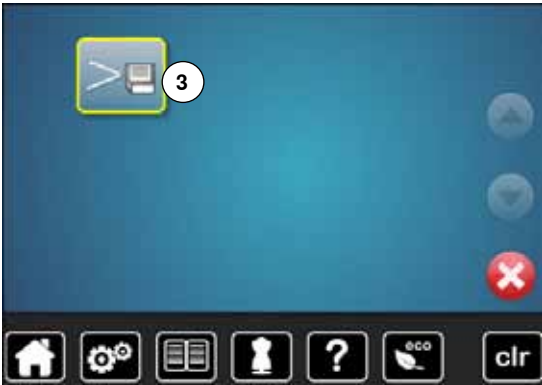

- touch «Save»-icon 3
- ▶ the altered zig-zag is saved
- ▶ the Display closes



**Programming/Saving second stitch pattern**

- touch «Buttonhole»-button
- select standard buttonhole No. 51
- save the stitch pattern as described above
- save any other stitch pattern in the same way



**Stitch pattern selection in the Personal program**

- touch «Personal program»-button

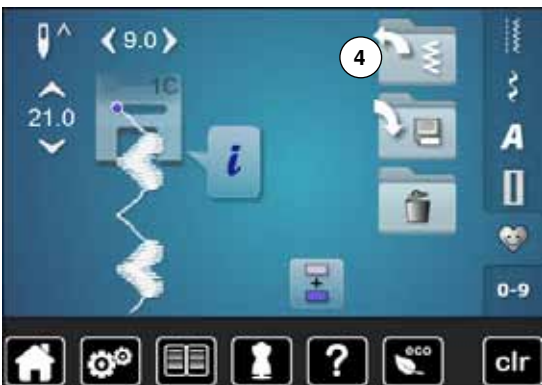

- touch «Open»-icon 4



**«Personal»-display**

- ▶ the programmed stitch patterns are displayed in pictures as well as with stitch width and stitch length
- further stitch patterns can be scrolled by using the arrow icons

## Alerting/Overwriting stitch patterns



### Selecting stitch pattern

- touch «Personal program»-button 1
- select zig-zag
- make alterations
  - ▶ stitch width and stitch length are altered (yellow numbers)
- touch «Personal program»-button
- touch «Save»-icon

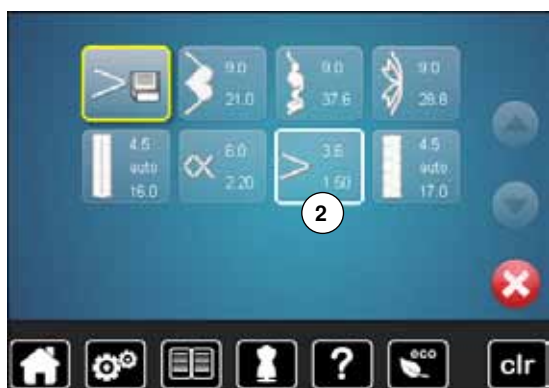

- select zig-zag 2



- confirm with ✓
- ▶ the alterations are saved

## Deleting stitch patterns



### Selecting stitch pattern

- touch «Personal program»-button
- touch «Delete»-icon 1



- select the stitch pattern to be deleted



- confirm with ✓
- ▶ stitch pattern is deleted
- ▶ the remaining stitch patterns are moved by one position

## Combi mode

The sewing-/embroidery computer has a memory system where both, the sewing and embroidery memories are saved.

In the sewing memory stitch patterns, lettering and numbers can be combined and saved.

In the sewing memory each «Drawer» can store a maximum of 70 stitch patterns as long as there is sufficient free space (capacity) available. If the storage space (but not all drawers) is full, there may be too many embroidery designs in the memory.

The memory is long-term, i.e. contents are kept until they are deleted. A power cut or switching off the sewing-/embroidery computer does not have any effect on the stored contents.

## Creating stitch combinations



### Programming and saving

- touch «Decorative stitch»-button
- select category
- touch «Combi mode»-icon
- select the desired stitch pattern directly or type in the number
- make any alteration concerning stitch length, stitch width, needle position etc.
- select another stitch pattern

- 1 • touch «Memory»-icon 1

- touch «Save»-icon 2

- touch «Save»-icon 3
- ▶ the combination is saved
- ▶ the Display closes

## Deleting Stitch Patterns



### Deleting individual stitches

- touch the «Delete»-icon
- ▶ stitch pattern above the cursor are deleted
- touch the «Delete»-icon as many times until the stitch altering area is empty



### Deleting entire combination

- touch «i»-icon
- touch «Edit the complete combination»-icon
- touch the «Delete»-icon
- confirm with ✓
- ▶ the stitch altering area is empty
- touch «Back»-icon
- a new pattern combination can be programmed

## Opening a saved combination



- touch «Memory»-button
- touch «Open»-icon 1

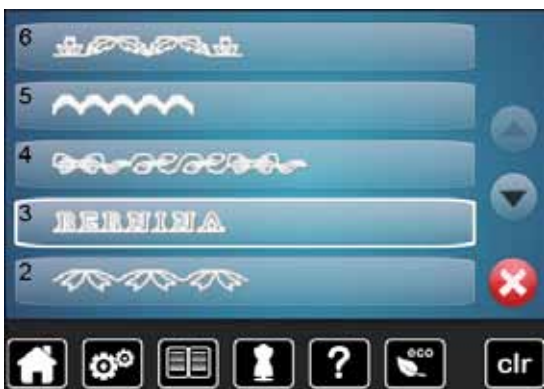

- ▶ a summary of the saved combinations appears
- touch the desired drawer
- ▶ the saved combination appears in the stitch altering area

## Correcting a stitch pattern combination



### Inserting a stitch pattern

- select the desired position in the combination
- select the new stitch pattern
- ▶ the new stitch pattern is inserted below the selected stitch pattern



To insert a stitch pattern at the beginning of a combination the cursor must be positioned above the **first** stitch pattern.



### Altering stitch patterns

- select the desired stitch pattern in the combination
- touch «i»-icon
- select desired function, e.g. Mirror image left/right
- ▶ the stitch pattern is mirrored left/right
- touch «Back»-icon



The alterations always affect the stitch above the cursor. Saved stitch combinations can be altered or corrected in the same way. To make corrections and alterations permanent, the combination must be saved again afterwards.



#### Mirroring complete combinations

- touch «i»-icon
- touch «Edit complete combination»-icon
- touch «Mirror image»-icon
- ▶ the complete combination is mirrored
- touch «Back»-icon twice

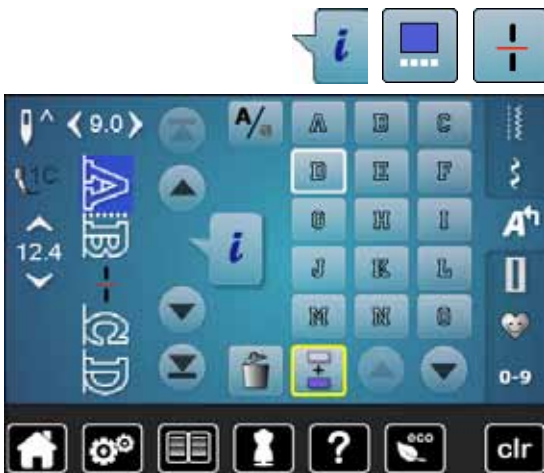

#### Combination subdivider 1

- touch «i»-icon
- touch «Edit combination at cursor position»-icon
- touch «Subdivide combination 1 »-icon
- a combination can be subdivided into several sections with the «Subdivider 1 »-function
- ▶ only the section where the cursor is positioned is sewn
- to sew the next section, the cursor must be placed in the respective section



#### Interrupting a combination

- touch «i»-icon
- touch «Edit combination at cursor position»-icon
- touch «Subdivider 2»-icon
- a combination can be interrupted at any position using «Subdivider 2»-function
- sew the first section
- ▶ the sewing computer stops automatically when it reaches the programmed function
- reposition the fabric
- sew the next part etc.



## Stitch pattern combination



### Overwriting

- program a new stitch combination
  - touch «Memory»-button
  - touch «Save»-icon
  - select the drawer to be overwritten (e.g. 3)
  - confirm with ✓
- Touch ✗ to cancel the overwriting procedure.



### Deleting

- touch «Memory»-button
  - touch the «Delete»-icon
  - select the Drawer to be deleted (e.g. 5)
  - confirm with ✓
- Touch ✗ to cancel the deleting procedure.

# Contents Embroidery

<b>Accessory</b>	<b>123</b>	<b>«Edit»-display</b>	<b>138</b>
Standard Accessory	123	Overview «Edit»-display	138
<b>Embroidery module</b>	<b>124</b>	General Functions	138
Detail view	124	Overview Embroidery menu	142
<b>Important embroidery information</b>	<b>125</b>	Overview Selection menu	145
Embroidery threads	125	Overview Color Display	146
Lower threads	125	<b>Embroidery motifs</b>	<b>147</b>
Choosing the embroidery motif	126	Selecting an embroidery motif	147
Embroidery test	126	Alphabets	147
Scaling/Sizing motifs	126	• Selecting alphabet	147
Different stitch types	127	• Entering/Correcting lettering	147
• Underlay stitches	127	• Deleting lettering	147
• Satin stitch	127	• Corrections	147
• Step stitch	127	BERNINA motifs	148
• Connecting Stitches	127	My Designs	148
<b>Preparing for embroidery</b>	<b>128</b>	<b>Motifs in combination with functions</b>	<b>149</b>
Attaching the Module	128	Move motif	149
Embroidery foot/Embroidery needle	129	Enlarging or reducing motif proportionally	149
Straight-/CutWork stitch plate	129	Rotate motif	149
Threading upper and bobbin thread	129	Mirroring motifs	150
Embroidery hoop	130	Motif Center	150
• Center determination	130	Absolute embroidery check	151
• Using the embroidery hoop	130	Select Hoop	151
• Embroidery template	130	Zoom	152
• Hooping the material	130	Moving the Motif	152
<b>Stabilizer</b>	<b>131</b>	Motif size and embroidery time	152
Stabilizers	131	Motif colors	153
Adhesive Spray	131	Changing the thread brand	153
Iron-on interfacing	132	Embroidering motifs in one color	154
• Paper-backed adhesive stabilizer	132	Basting	154
• Water soluble stabilizer	132	• Deactivating basting	154
<b>Functions</b>	<b>133</b>	<b>Saving Motifs</b>	<b>155</b>
Overview «Function»-buttons embroidery computer	133	Embroidery computer memory	155
• «Start/Stop»-button	133	Stick	156
• «Presser foot position»-button	133	<b>Overwriting motifs</b>	<b>157</b>
• Automatic thread cutter	133	<b>Deleting saved single motif</b>	<b>158</b>
• Stitch width and stitch length knob	133	<b>Deleting all saved motifs</b>	<b>159</b>
• Speed control	133	<b>Starting to embroider</b>	<b>160</b>
<b>Overview Display</b>	<b>134</b>	Select hoop	160
Entry to Embroidery mode	134	• Attaching the embroidery hoop	160
Embroidery Alphabet	135	• Attach the hoop to the embroidery arm	160
BERNINA motif	136	• Removing the hoop	160
My Design	136	Embroidery menu	161
Embroidery motif from USB-Stick (optional accessory)	137		

<b>Embroidering using the «Start/Stop»-button on the headframe</b>	<b>161</b>
• Interrupting the process	161
• Completing the color	161
• Changing color	161
• «Embroidery»-display	161
<b>Embroidering with foot control</b>	<b>162</b>
• Interrupting with the foot control	162
• Completing the color	162
• Changing color	162
• «Embroidery»-display	162
<b>Thread breakage when embroidering</b>	<b>163</b>
Upper or lower thread breaks	163
Embroidery sequence control when thread breaks	163
<b>Cleaning</b>	<b>164</b>
<b>Troubleshooting</b>	<b>166</b>
<b>Overview Stitch patterns</b>	<b>171</b>
Practical stitches	171
Buttonholes	171
Decorative stitches	171
Quilt stitches	173
Alphabets	174
<b>Overview Motifs</b>	<b>177</b>
<b>Alphabets</b>	<b>185</b>
<b>Index</b>	<b>186</b>

## Accessory

### Standard Accessories

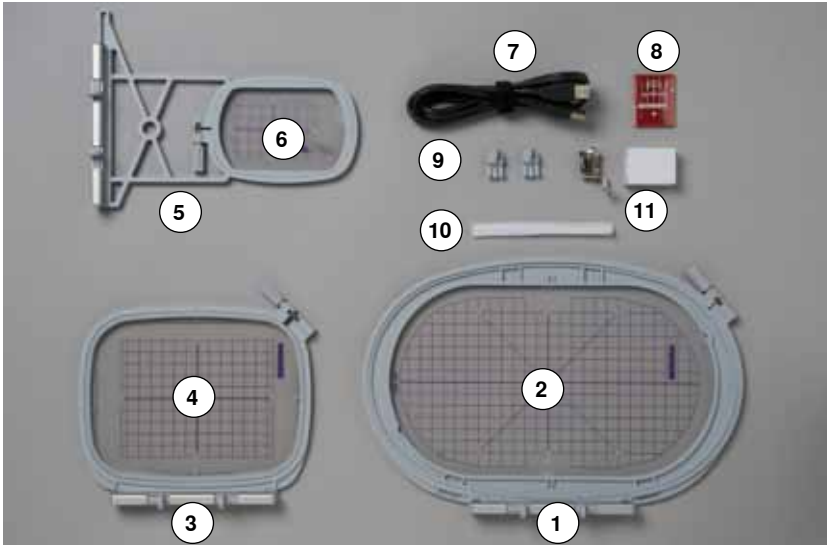

- 1 Embroidery hoop oval, 145x255mm
- 2 Embroidery template for embroidery hoop oval, VAR 00
- 3 Embroidery hoop medium, 100x130 mm
- 4 Embroidery template for medium embroidery hoop
- 5 Embroidery hoop small, 72x50mm
- 6 Embroidery template for embroidery hoop small, blue
- 7 USB connecting cable
- 8 Embroidery needle pack (SUK)
- 9 Template holder
- 10 Net for thread spool, white
- 11 Embroidery foot No. 26

## Embroidery module

### Detail view



- 1 Embroidery arm
- 2 Sewing computer guide rails
- 3 Bracket for attaching embroidery hoop
- 4 Connection to the sewing computer



- 5 Connection for embroidery module

## Important embroidery information

### Embroidery threads

A good quality thread is essential for embroidery to avoid poor stitch quality, thread breakage, etc.

Embroidery is particularly effective if you use 40wt glossy rayon or polyester embroidery threads as upper threads. They are available in a wide range of colors for beautiful embroidery.



#### **Polyester threads**

Polyester with a brilliant sheen is a hard wearing colorfast thread and has a high tensile strength which is suitable for all types of embroidery.

#### **Rayon threads**

Rayon is a soft viscose fiber with a brilliant sheen and suitable for fine, delicate embroidery, or items that will not receive excessive wear and tear.

#### **Metallic threads**

Metallic thread is a light- to medium weight thread suitable for special effects in embroidery. Reduce the speed and upper thread tension when embroidering with metallic threads.

#### **Embroidery needle**

- correct size thread must correspond with correct size needle
- replace the needle regularly



Use the vertical spool pin and attach the supplemental thread guide (optional accessory) when using guide eyelet for metallic and silk thread. A Metafil 130/705H-MET need is recommended for embroidering with metallic threads. Adjust upper thread tension and reduce the embroidery speed.

### Lower threads



#### **Bobbin Fill (special bobbin thread)**

Bobbin Fill is an especially soft and light polyester thread suitable for bobbin thread. This special bobbin thread ensures a steady thread tension and an optimal intertwining of the upper and bobbin thread.

#### **Darning and embroidery thread**

Fine mercerized cotton thread which suits for embroidering on cotton.



In most cases, bobbin thread for embroidery is either white or black. Some special cases require same thread in top and bobbin.

## Choosing the embroidery motif

Simple motifs with a low stitch count are suitable for embroidery on fine material. Large-scale, densely embroidered motifs (e.g. with multiple color and embroidery direction changes) are suitable for medium and heavy weight material.

## Embroidery test

Always test stitch the embroidery motif on the same type material. Use the same stabilizer as will be used on the finished project. Changes colors, stabilizer type or needle if needed to suite the motif/fabric combination.

## Scaling/Sizing motifs

Motifs can be scaled/sized using the on-screen icons or with the BERNINA Embroidery Software on the PC. Increasing/decreasing in a range of +/- 20 % provides the best results.

## Different stitch types

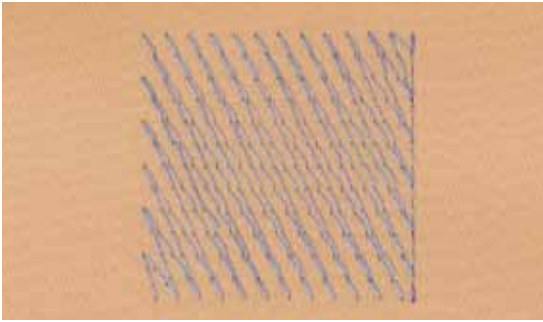

### Underlay stitches

Underlay stitches are the foundation of a motif and are used to stabilize the base material and hold it in shape. They also prevent the covering stitches of the motif from sinking into the knit or the nap of the material.

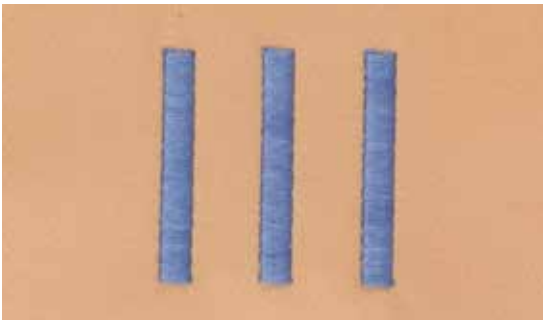

### Satin stitch

The needle moves left to right and vice versa. The result is a very dense, covering zig-zag stitching to fill the shape. Satin stitching fills are ideal for narrow and small shapes. Satin stitching is, however, not suitable for larger areas, since wide stitches are too loose and do not cover the fabric properly. In addition there is the danger that with too long stitches the threads could catch on something which would damage the embroidery.

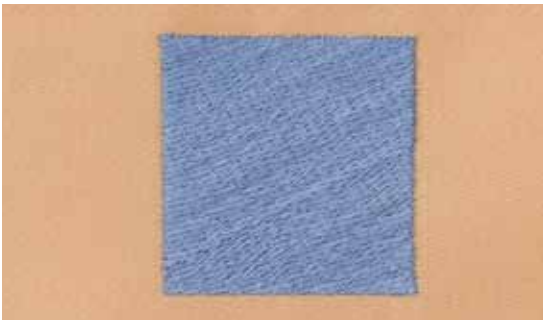

### Step stitch

A fill stitch with stitches of specified length sewn in rows used primarily to fill large areas quickly.

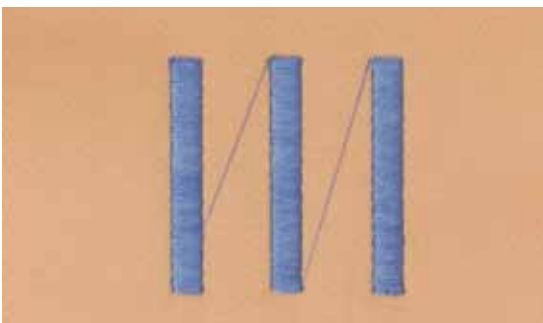

### Connecting Stitches

Jump stitches which are used to get from one part of the motif to the next. Before and after the jump stitch securing stitches are sewn. Jump stitches are trimmed before the next color starts to embroider.



## Preparing for embroidery

### Attaching the Module

#### ATTENTION!

The slide-on table must not be attached while the embroidery module is being attached or removed.

When attaching the embroidery module ensure that all the units are on the same even surface.

The embroidery computer may run at high speeds when embroidering. Therefore the two units must be placed on a stable surface or the motor speed reduced when embroidering.

Make sure that there is enough space around the sewing computer and embroidery module to allow the unimpeded movement of the embroidery arm!

Always separate the sewing computer and the embroidery module from one another before transporting – do not transport as a single unit.

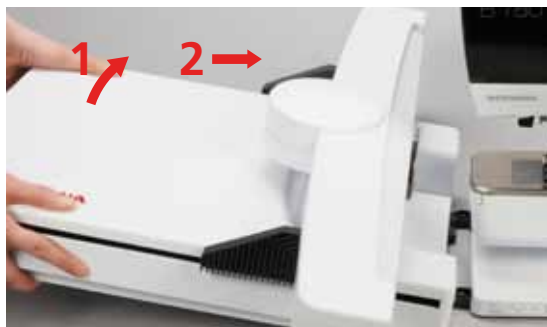

#### Attaching the Module to the Sewing computer

- lift the embroidery module on the left and
- carefully slide it from left to right into the sewing computer connection



#### Removing the Module from the Sewing computer

- lift the embroidery module on the left and carefully pull out and off to the left



#### Attach slide-on table

The slide-on table can only be attached with the embroidery module arm to the far left. If necessary, use the «Park Module» function to move it, see page 140.

## Embroidery foot/Embroidery needle

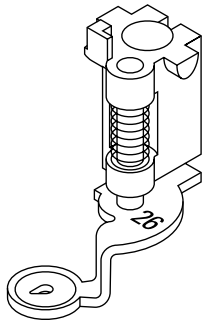

### Embroidery needle

Embroidery needles (130/705 H-SUK) provide a larger eye and are slightly rounded. This avoids thread abrasion when using Rayon- and cotton embroidery thread.

- use SUK-needles
- depending on the embroidery thread use a size No. 70-SUK to No. 90-SUK needle
- exchange the needle regularly

### Preparation

- attach embroidery foot No. 26 to the embroidery computer
- raise the presser foot
- raise the needle



### Lowering the feed dog

- press «Feed dog»-button 1
- ▶ the feed dog is lowered

## Straight-/CutWork stitch plate (optional accessory)

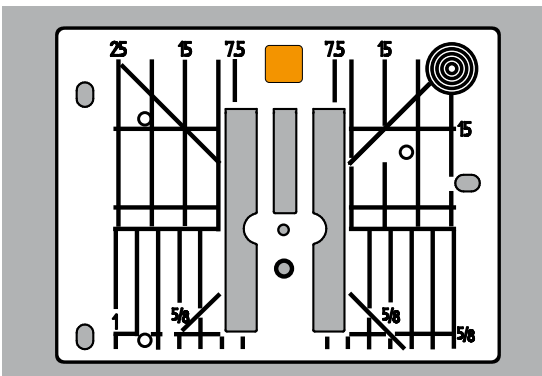

The straight-/CutWork stitch plate has a small needle hole in the needle insertion area. The small needle hole supports the fabric. This optimizes the stitching results.

- remove the standard stitch plate (see page 25)
- replace it with the straight-/CutWork stitch plate

## Threading upper and bobbin thread

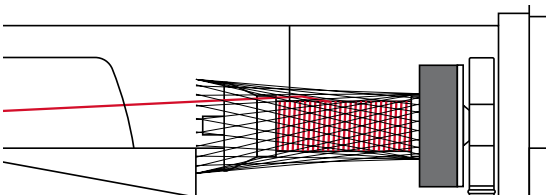

### Threading upper thread

- place foam pad on the spool holder
- attach thread spool
- when using Rayon or slippery embroidery threads, slip the net over the upper thread spool
- ▶ this will feed the needle thread more evenly



### Spool pin

When using metallic or specialty threads, using the vertical spool pin and the use the special eye (optional accessory) for metallic and silk threads.

### Threading bobbin thread

- thread the lower thread for embroidering in the same way as for sewing, see page 21.



Insert the bobbin case and close the bobbin cover to activate the lower thread indicator (must be activated in the Setup-Program).

## Embroidery hoop

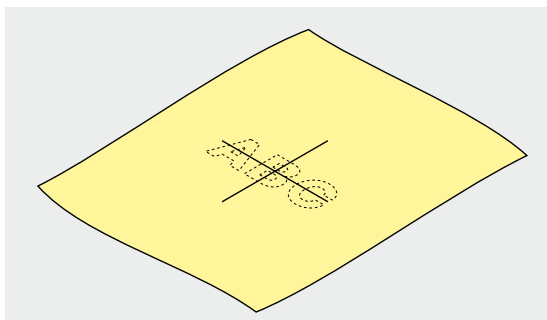

### Center determination

- determine the location of the center of the design within the fabric
- mark the material with fabric marker or chalk

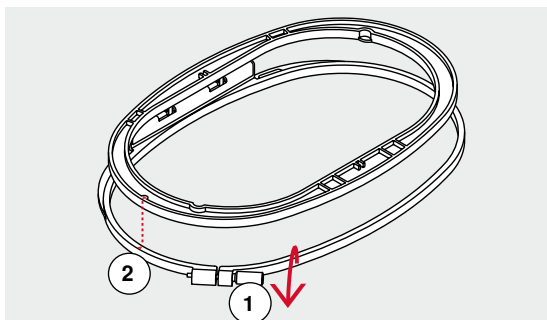

### Using the embroidery hoop

- loosen the screw **1** of the outer hoop if necessary
  - remove the inner hoop
- Match the arrows **2** of both hoops.

The arrows are

- on the oval and medium hoop at the center front
- on the small hoop to the right side
- on the Mega Hoop and Jumbo-Hoop (optional accessory) at the center front

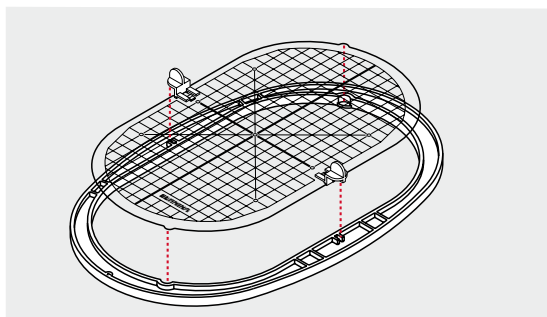

### Embroidery template

- there is an embroidery template for each hoop
- the embroidery area is marked in 1 cm squares
- the center and end point are marked with holes
- for transferring marks to the material
- attach the embroidery template holder
- place the template in the inner hoop, so the BERNINA logo is at the front edge (by the arrows) and can be read
- ▶ in this position the embroidery template clicks into the inner hoop

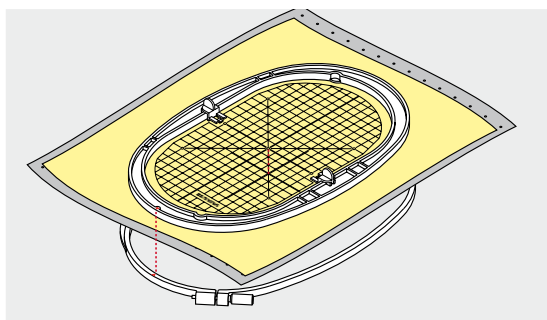

### Hooping the material

- place the material under the inner hoop
- line up the marked center point on the center of the template
- place the material and inner hoop on the outer hoop

Match the arrows of both hoops.

- fit hoops into each other; ensure that the material does not move
- hoop the material to be embroidered tightly
- tighten the screw
- remove the template from the hoop by using the template holder

## Stabilizer

### Stabilizers

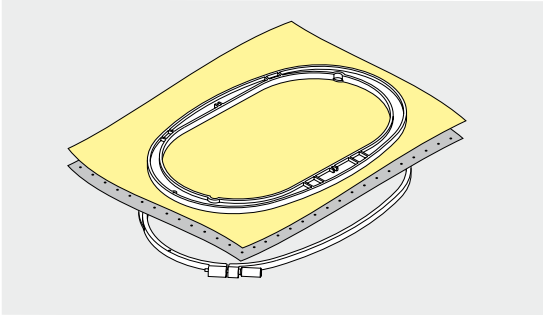

#### Tear-away stabilizers

- excess is easily torn away
- one or more layers can be used
- available in different weights
- for more stability, apply to the wrong side of the material with temporary adhesive spray before hooping
- carefully tear away excess stabilizer from the back of the embroidery after stitching
- motifs are not skewed
- stabilizer will remain under larger embroidered areas

#### Application:

For all woven materials and materials without stretch.

#### Cut-away stabilizers

- one or more layers can be used
- available in light and heavy weight
- for more stability, apply to the wrong side of the material with temporary adhesive spray before hooping
- carefully cut away from the back of the embroidery after stitching
- motifs are not skewed
- stabilizer will remain under larger embroidered areas

#### Application:

For all elastic materials.

### Adhesive Spray

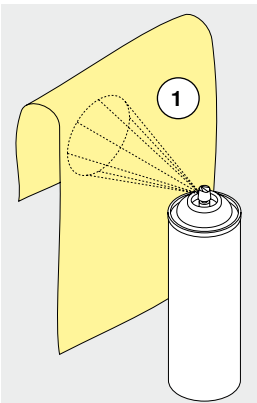

Avoid using spray adhesive next to your embroidery system.

- at a distance **1** of 25-30cm
- use adhesive spray carefully
- spray the stabilizer and adhere to the wrong side of the material carefully smoothing material so there are no puckers

#### Application:

- stretch and knitted material: to retain shape
- smooth material: to avoid slipping of material layers
- appliqués can be exactly positioned
- material pieces: position material pieces on stabilizer, e.g. pocket flaps
- napped materials (i.e. velvet) that should not be clamped in the hoop because of the possibility of getting hoop marks
- to fix parts to be embroidered

#### Spray starch for additional stiffening

Spray starch is ideal for additional stiffening fine, soft or loosely woven materials.

- spray the area to be embroidered
- let dry; or press gently with a warm iron if necessary

Always use an additional stabilizer such as water soluble stabilizer on the wrong side of the material.

#### Application:

Ideal for fine, loosely woven materials, e.g. batiste, fine linen, etc.

## Iron-on interfacing

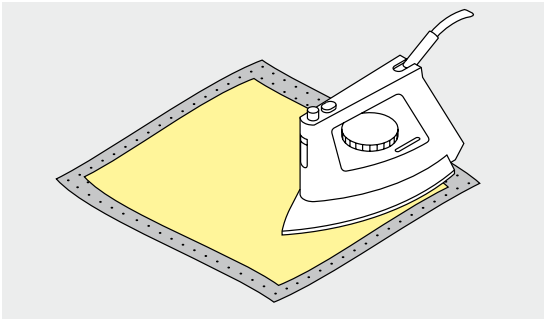

Iron-on interfacings are available in a variety of weights. Iron-on interfacings should be selected to suit the material being used. Use an iron-on interfacing which is easily removable from the material.

- iron-on interfacings are pressed (fused) to the wrong side of the material

Application:

To provide body and shape for materials onto which motifs will be placed, use in conjunction with appropriate stabilizer.

### Paper-backed adhesive stabilizer

- place stabilizer in hoop, paper side up
- use a pointed object (e.g. scissors) to score the paper
- remove paper to reveal the self-adhesive surface
- ▶ the self-adhesive surface reveals
- position the material to be embroidered on the stabilizer and smooth in place

Application:

- intended for delicate materials such as jersey or silk etc.
- for hard to hoop materials and materials such as velvets



Make sure that the adhesive residue on needle, stitch plate and hook area is removed.

### Water soluble stabilizer

Water soluble stabilizer looks like plastic wrap. Dissolve stabilizer in warm water when the embroidery is complete. Water soluble stabilizers are ideal protection for materials with a thick or looped pile such as toweling. This prevents the threads from sinking into the material and prevents the material from showing through the embroidery stitches.

- place on top of the material
- place all the layers together into the embroidery hoop
- use adhesive spray to fix stabilizer if necessary
- for material with a pile, reinforce with additional, suitable stabilizer on the wrong side
- after dissolving lay the motif down flat and let dry

Application:

- ideal for toweling, velvet, bouclé etc.
- ideal for fine, sheer materials such as organdy, batiste, etc.
- for lace embroidery



For lace embroidery place one or two layers of water soluble stabilizer in hoop (as the motif is not embroidered on any material, only the thread embroidered motif is left). Embroidery motifs must be combined with short stitches otherwise the individual motifs may fall out.

## Functions

### Overview «Function»-buttons embroidery computer



#### «Start/Stop»-button

Press the button to start or stop the embroidery computer.



#### «Presser foot position»-button

- press the button
- ▶ the presser foot is lowered a bit and lifted again for easy positioning of the material
- ▶ the presser foot is lowered on the fabric when start sewing
- press button again
- ▶ presser foot is lifted

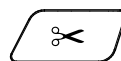

#### «Automatic thread cutter»-button

- press button
- ▶ the upper and the lower thread are cut automatically

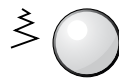

#### Stitch width and stitch length knob

The knobs provide different functions and are used to edit the motifs, e.g. altering motif size, to rotate the motif etc. A message appear to indicate the knobs must be used.

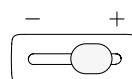

#### Speed control

The sewing and embroidering speed is infinitely variable with the slide.

## Overview Display

### Entry to Embroidery mode



- press «Home»-button



#### Embroidery mode

- touch «Embroidery mode»-icon 2
- ▶ the «Embroidery»-display appears

#### Sewing mode

- press «Sewing mode»-icon 1
- ▶ the «Sewing»-display appears



#### Embroidery computer

To select embroidery motifs from the folders «Alphabets», «Motifs», or «My Designs».



#### USB-Stick (optional accessory)

To select embroidery motifs which are saved on the USB stick.



#### Alphabets

To select built-in alphabets.



#### Embroidery motifs

To select built-in embroidery motifs.



#### My Designs

To select saved embroidery motifs.

## Embroidery Alphabet

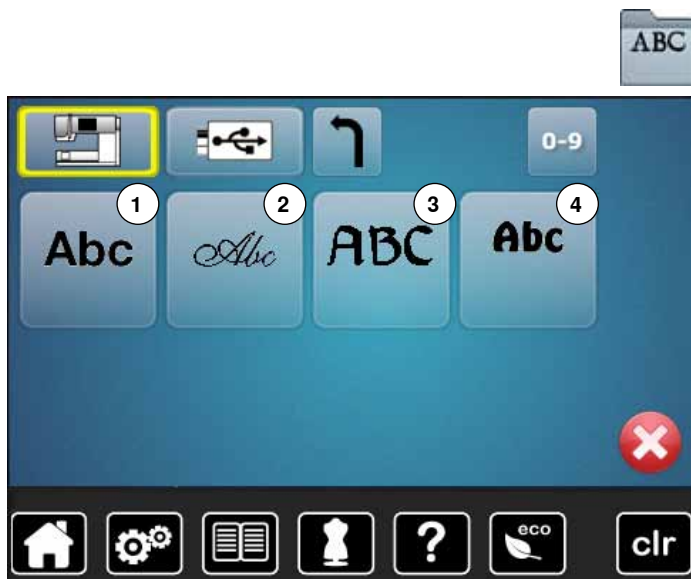

- touch «Alphabet»-icon

- select desired alphabet

- 1 Swiss Block
- 2 Anniversary
- 3 Guinevere
- 4 Drifter



**Return to selection menu**  
Back to the «Selection»-display.



## BERNINA motif

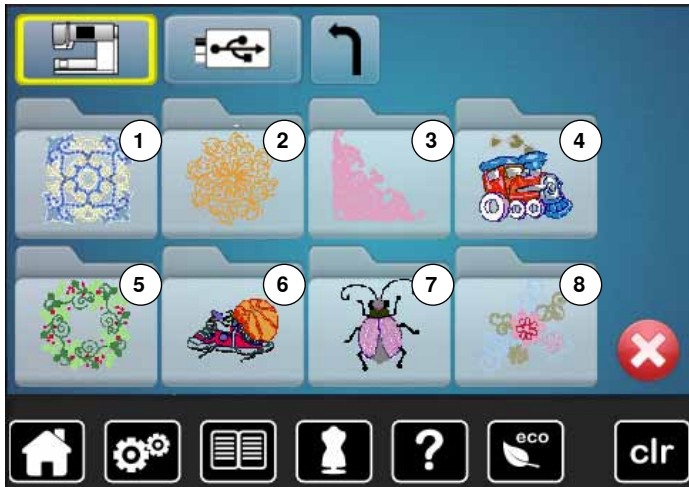

- touch «Embroidery motif»-icon

- select desired embroidery motif folder

- 1 Embellishment
- 2 Quilting
- 3 Borders and Lace
- 4 Children
- 5 Seasons
- 6 Sports and Hobbies
- 7 Animals
- 8 Flowers

## My Design



- touch «My Design»-icon

- touch the desired motif

## Embroidery motif from USB-Stick (optional accessory)



- insert USB-Stick
- touch «USB-Stick»-icon
- touch the desired motif



## «Edit»-display

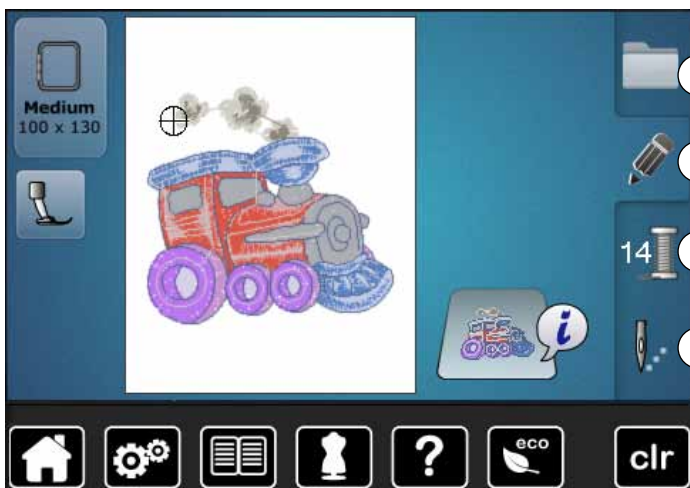

- 1 Selection
- 2 Edit
- 3 Color Numbers
- 4 Embroidery Menu

## Overview «Edit»-display

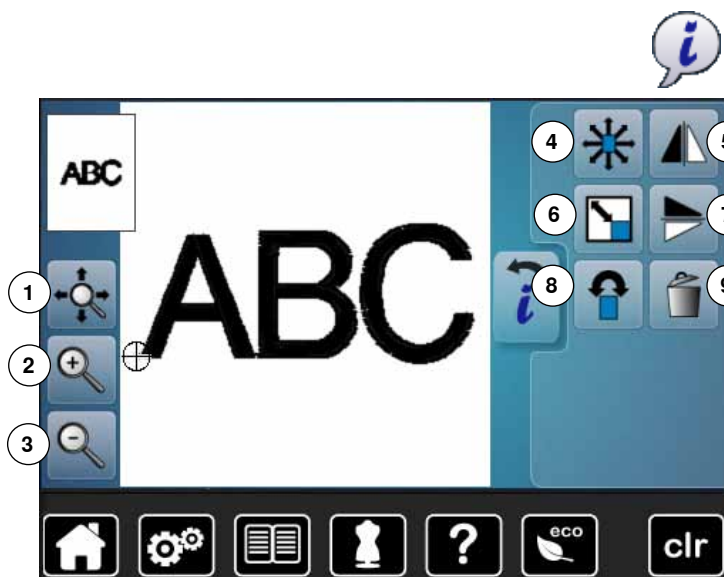

- select alphabet or motif
- touch «i»-icon

Some functions feature tips for the operating of the stitch width and stitch length knobs.

### Functions

- 1 Moving the view of the motif within the hoop
- 2 Zoom plus
- 3 Zoom minus
- 4 Move motif
- 5 Mirror Image (left/right)
- 6 Enlarging or reducing motif proportionally
- 7 Mirror Image (down/up)
- 8 Rotate motif
- 9 Deleting motif

## General Functions



### Information

- touch the button
- ▶ another Display is opened



### Back

- touch the button
- ▶ goes back to the previous Display
- ▶ any alterations are accepted



### Confirming selection

- touch the button
- Alteration/Selection is activated or confirmed.



### Leaving the active Display

- touch the button
- ▶ the Display is closed
- ▶ the previous Display appears



### Moving the view of the motif within the hoop

The embroidery motif can be moved within the hoop to any direction using the finger directly in the Display.



### Zoom plus

- touch icon 1-5x
- ▶ the displayed embroidery is enlarged by one step



### Zoom minus

- touch icon 1-5x
- ▶ the Display of the enlarged motif is reduced by one step



### Moving the motif

Display of the alteration in 1/10mm.

- turn stitch width knob
- ▶ the motif is moved sideways (horizontally)
- turn stitch length knob
- ▶ the motif is moved lengthwise (vertically)
- turn stitch width and stitch length knob
- ▶ the motif is moved diagonally (the same number is in both icons)

By using the finger the motif can also be moved to any direction, directly in the Display.



### Deleting motif

Active embroidery motif is deleted.



### Mirror image (left/right)

The motif is mirrored horizontally (left/right).



### Altering the motif proportionally

Displayed alteration in %.

- turn stitch width knob to the right
- ▶ the motif is enlarged
- turn stitch width knob to the left
- ▶ the motif is reduced



### Mirror image down/up

The motif is mirrored vertically (down/up).



### Rotate motif

Display of position in degrees (°).

- turn stitch width knob to the right
- ▶ the motif rotates to the right
- turn stitch width knob to the left
- ▶ the motif rotates to the left
- touch «+90»-icon 1-4x
- ▶ the motif rotates to the right in 90°-steps (0°, 90°, 180°, 270°, 360°)

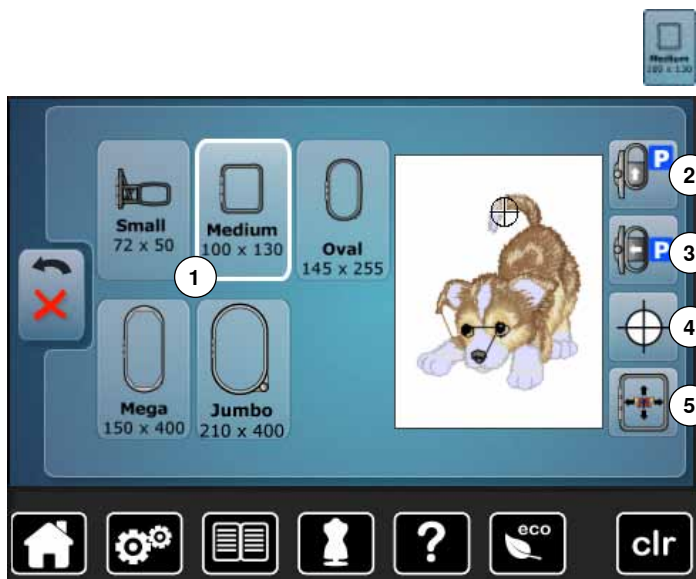

- touch «Hoop size»-icon

#### Functions

- 1 Select Hoop Menu
- 2 Move hoop to back
- 3 Parking the module
- 4 Motif center
- 5 Virtual positioning



#### Select hoop menu

- ▶ the optimal hoop for the motif selected is displayed
- touch the button
- ▶ the Display with the Select Hoop and further functions appear



#### Move hoop to back

- ▶ the hoop moves vertically to the far back
- Better access for changing the bobbin.



#### Parking the embroidery module

- remove embroidery hoop
  - ▶ the embroidery arm travels horizontally to the left to the park position
  - change to the sewing mode
- Sewing is possible even with the embroidery module attached.



#### Motif center

The exact motif center is indicated by the cursor. The embroidery hoop is moved until the needle is positioned exactly in the center of the embroidery motif when the function «Virtual positioning» is activated.



#### Virtual Positioning

Icon is inactive = if the motif is repositioned, the hoop does not move.

- touch the button
- If the motif is repositioned, the hoop simultaneously moves along with it to the new position. This function is only visible when an embroidery hoop is attached.





## Overview Embroidery menu



- press «Embroidery menu»-button

With some functions the instruction to use the knobs appears.

### Functions

- 1 Presser foot indicator
- 2 Security program
- 3 Color information
- 4 Upper thread tension
- 5 Selection
- 6 Thread breakage
- 7 Edit
- 8 Cut jump stitches
- 9 Color numbers
- 10 Single/Multi-Color motif
- 11 «Embroidery menu»/«Start/Stop»-button



### Presser foot indicator

Embroidery foot No. 26 is displayed by default.

- touch the button
- ▶ further presser feet, such as e.g. free motion couching foot No. 43, are displayed and can be selected
- attach and select the appropriate presser foot for the project



### Security Program

- touch the button

- touch desired «Needle»- and/or «Stitch plate»-icon
- ▶ if the «Security»-icon is yellow-framed, the correct stitch plate is not attached or selected

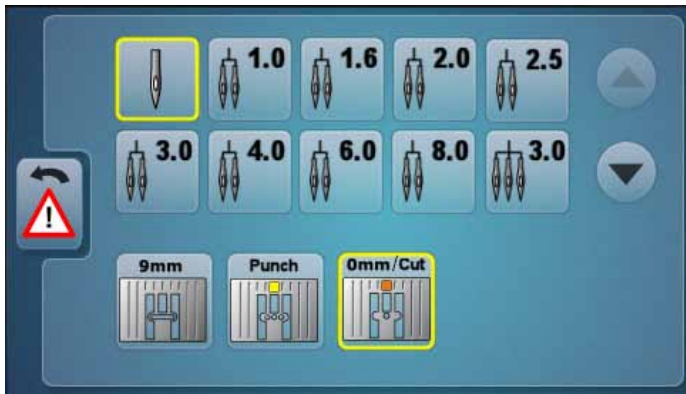

### Color information

Information about the active color.

- touch arrow icons left/right
- ▶ the current color is changed
- ▶ the hoop moves to the first stitch of the current color

The active color can also be embroidered individually or in another sequence.



#### Upper thread tension

Altering Upper thread tension.

- ▶ the respective value is visible in the icon



#### Selection

- select new motif
- save motifs
- delete motifs



#### Thread breakage

In the left Display the motif is shown in the normal size.  
In the right Display the motif is enlarged.



#### Edit

In this Display the motif can be edited.



#### Cut jump stitches

By default the function is active (yellow-frame). Jump stitches are automatically cut.

- touch the button
- jump stitches must be trimmed manually



#### Color numbers

Display of the motif color numbers.

- touch the button
- ▶ Display providing the color information to the selected motif is opened



#### Single/Multi-Color Motif

If the icon is active, the entire motif will be embroidered in one color (without stopping).

If the icon is inactive, the colors will be embroidered individually.



#### Embroidery menu/Start/Stop

The alternating blinking symbols indicate:

- ▶ the «Embroidery»-display is opened
- ▶ the embroidery computer is ready to embroider

The embroidery computer must be started by pressing the «Start/Stop»-button on the headframe.





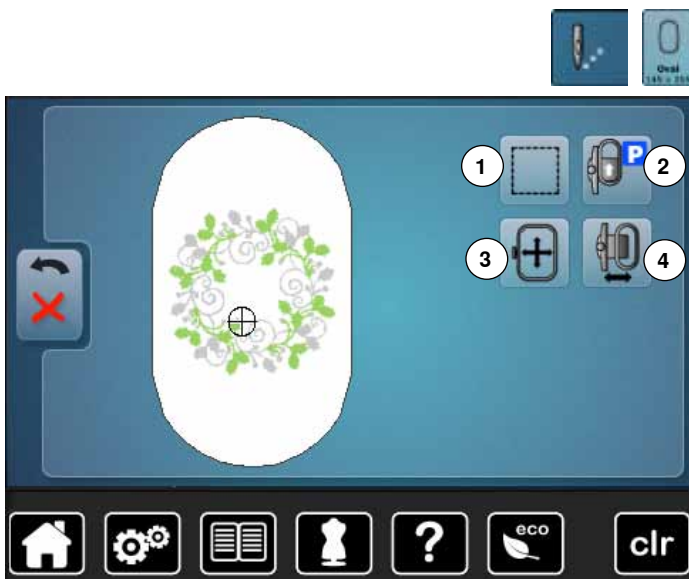

With some functions the instruction to use the knobs appears.

### Functions

- 1 Basting
- 2 Moving Hoop to Back
- 3 Moving hoop by using the knobs
- 4 Embroidery hoop movement



#### Basting

- touch the button
- ▶ the embroidery motif is outlined with a straight stitch
- touch icon again, the symbol changes
- ▶ the basting is now done along the hoop
- touch the icon again
- ▶ Basting box function is switched off



#### Move hoop to back

- ▶ the hoop moves vertically to the far back
- Better access for changing the bobbin.



#### Moving the hoop

- If the fabric has to be re-hooped when stitching a large embroidery motif (e.g. lettering, borders etc.), the hoop has to be moved to the last stitch of the already embroidered part with the stitch width and stitch length knob.
- ▶ the movement is displayed in the icons



#### Moving the hoop to the left

- ▶ the hoop moves horizontally to the center
- touch **X**
- press «Start/Stop»-button
- ▶ the hoop moves back to the previous position

## Overview Selection menu



- press «Selection»-button

### Functions

- 1 New motif
- 2 Saving motif
- 3 Deleting motif



#### New Motif

- ▶ the overview of the previous Display is opened (Alphabet, Motifs, My Designs)
- select the desired motif



#### Saving Motif

- ▶ the «Save»-display is opened



#### Deleting Motif

- ▶ the «Delete»-display is opened

## Overview Color Display

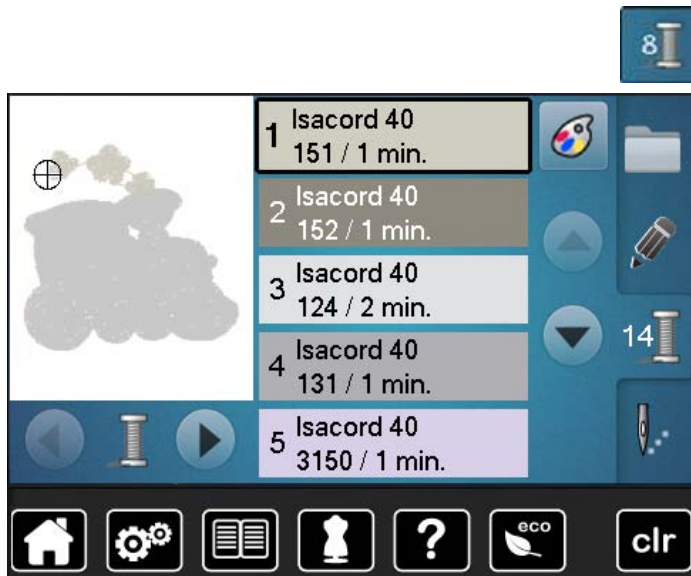

- press «Color number»-button



### Changing the thread brand

- ▶ the Display showing different thread brands is opened

## Embroidery motifs

### Selecting an embroidery motif



Various embroidery motifs from the «Alphabets», «Motifs» and «My Designs» files can be selected.

### Alphabets



#### Selecting alphabet

- touch «Alphabet»-icon
- ▶ the various alphabet types are visible in the Display
- touch the desired «Alphabet»-icon



#### Entering/Correcting lettering

- ▶ the Display showing the keyboard is opened
  - the «ABC»-icon (upper case) is active automatically
  - select desired lettering
- The space bar is at the bottom of the letter keys.
- ▶ letters appear in the text bar 1
  - confirm with ✓

#### Deleting lettering

- touch text bar 1
- ▶ all entered text is deleted

#### Corrections

- touch the icon 2
- ▶ the entered text is deleted from right to left



- 3 «ABC» upper case characters (standard)
- 4 «abc» lower case characters
- 5 «Ä Ä Ä», «ä ä ä» and «@ #» upper and lower special characters
- 6 «1,2,3» numbers and mathematical characters



If all the lettering cannot be displayed in the hoop, rotate the lettering by 90°. There is then more room for the lettering in the entire length of the embroidery hoop.  
If this does not help, decrease the lettering size or reduce the number of letters.

## BERNINA motifs

All BERNINA embroidery motifs can either be embroidered as-is, or changed using the various functions offered by the embroidery computer.



- touch «Motif»-icon



### Motif overview

The motifs are displayed in folders according to topics.

- select folder
- select desired motif

## My Designs

All embroidery designs can either be embroidered as-is, or edited using the various functions offered by the embroidery computer.



- touch «My Design»-icon



### Motif Overview

- select the desired motif touching the icon or via «0-9»-icon

## Motifs in combination with functions

To activate the functions touch the appropriate icon and make alterations with the stitch width and stitch length knobs.

### Move motif



- touch «i»-icon
- touch «Move motif»-icon
- turn stitch width knob
  - ▶ the motif is moved horizontally
- turn stitch length knob
  - ▶ the motif is moved vertically
- the alteration is displayed in the icons in 1/10mm
- turn stitch width and stitch length knob
  - ▶ if both icons display the same number, the motif has been moved diagonally
- touch the yellow-framed icon or the «Center»-icon
  - ▶ the motif is repositioned to the center of the hoop

### Enlarging or reducing motif proportionally



- touch «i»-icon
- touch «Enlarging or reducing motif proportionally»-icon
- turn stitch width knob to the right
  - ▶ the motif is enlarged
- turn stitch width knob to the left
  - ▶ the motif is reduced
- the alteration is displayed in the icon in percent (%)
- touch yellow-framed icon
  - ▶ the size of the motif is reset to basic setting

### Rotate motif



- touch «i»-icon
- touch «Rotate motif»-icon
- turn stitch width knob to the right
  - ▶ the motif rotates to the right
- turn stitch width knob to the left
  - ▶ the motif rotates to the left
- the position is displayed in the icon in degrees (°)
- touch yellow-framed icon
  - ▶ the position of the motif is reset to basic setting (0°/360°)
- touch «+90»-icon 1-4x
  - ▶ the motif rotates in 90°-steps (0°, 90°, 180°, 270°, 360°)

## Mirroring motifs



- touch «i»-icon



- touch «Mirror image left/right»-icon
  - ▶ the motif will be mirrored horizontally
- touch «Mirror image down/up»-icon
  - ▶ the motif will be mirrored vertically

## Motif Center



- touch «Select hoop»-icon
- touch «Motif center»-icon

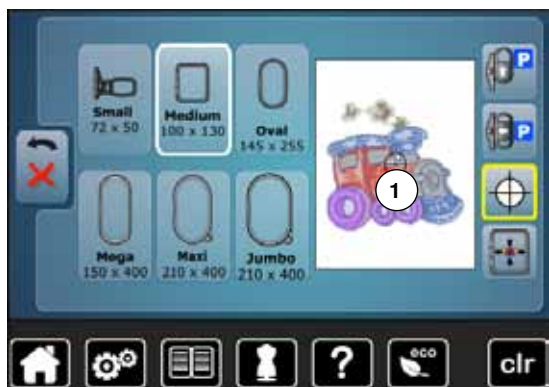

- ▶ center of motif 1 is shown in the the Display
- ▶ the hoop is moved until the needle is exactly in the center of the motif
- touch «Motif center»-icon again
- ▶ the first stitch of the motif will be marked again in the Display

## Absolute embroidery check



By using a blunt pen any position within the motif can be selected directly in the «Edit»-Display.

- select and edit motif
- attach the respective hoop

The «Motif center» icon must be deactivated in order to utilize Absolute check.

- check the motif within the hoop by using a blunt pen
- select any point in the motif by using a blunt pen
  - ▶ the cursor (marking the needle position) moves to the selected area
  - ▶ if the icon «Virtual positioning» **1** is activated (yellow-framed), the hoop is moved to position the needle over the selected area



If the thread breaks, the blunt pen can also be placed on the area of the Display where the thread broke. The hoop moves to that area.

## Select Hoop

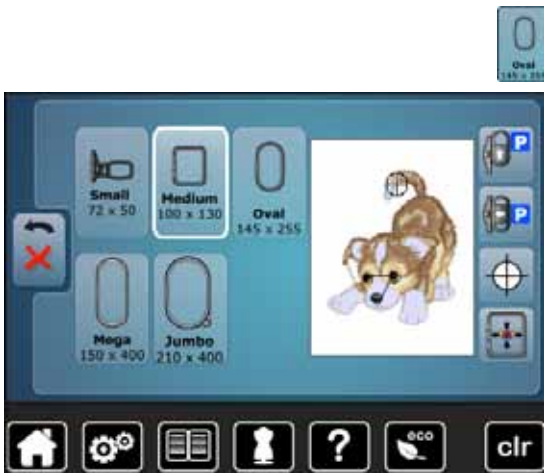

- select «Select hoop»-icon

For best embroidery results always use the smallest hoop possible for the motif.

- select desired hoop
  - ▶ the selected hoop is highlighted in white
- touch «Back»-icon
  - ▶ the Display is closed
  - ▶ the motif appears in the selected hoop



## Zoom



- touch «i»-icon
- touch «Zoom+»-icon 1-5x

▶ the view of the motif is enlarged by one step



- touch «Zoom-»-icon 1-5x
- ▶ the enlarged view of the motif is scaled-down by one step

## Moving the Motif



- touch «Move»-icon

Icon inactive:

- the position of the motif can be moved to any position **within** the hoop directly in the Display by using the finger

Icon active (yellow-framed):

- the view of the motif can be moved to any position the hoop directly in the Display by using the finger
- ▶ the embroider position is not changed

## Motif size and embroidery time



- touch «i»-icon

Width and height of the embroidery motif is displayed in millimeters (mm). The embroidery time is displayed in minutes.

## Motif colors



### Changing motif colors

- touch «Color number»-icon in the Display
- scroll with the arrow icons, if necessary, until the color to be changed appears
- select the color to be changed (e.g. 1)



- touch «Thread color»-icon
- scroll with the arrow icons until the desired color appears
- select the desired color or
- touch «0-9»-icon and
- enter the color number via the keyboard
- touch the white X to close the 0-9 window and confirm the selected color
- select color icon
- ▶ the new color is reallocated
- ▶ the altered color is displayed

## Changing the thread brand



- touch «Thread color»-icon
- scroll with the arrow icons left or right until the desired thread brand appears
- touch «Thread brand»-icon
- ▶ the thread brand in the Display changes and the new thread details appear
- touch «Back»-icon
- ▶ the altered thread details are displayed



Different thread brands can be assigned to the motif.

- scroll to the desired thread brand
- do **not** touch icon
- scroll to the desired color
- touch the icon

## Embroidery motifs

### Embroidering motifs in one color



- press «Embroidery menu»-button
- touch «Single/Multi-Color Motif»-icon
- ▶ the function is activated
- ▶ the embroidery computer embroiders the complete motif and stops when finished

### Basting



- press the «Embroidery menu»-button
- touch the «Select hoop»-icon
- touch «Basting»-icon

The embroidery motif is outlined with a straight basting stitch. This serves as an additional anchoring of the project so that the fabric and stabilizer are adhered.



- touch «Basting»-icon again
- ▶ the symbol changes



The basting is now done along the hoop.

#### Deactivating basting

- touch the icon again
  - ▶ Basting stitches are deactivated
- This function remains active even if a new motif is selected.

## Saving Motifs

Embroidery motifs from the embroidery computer, the USB stick or designs created in the BERNINA Embroidery Software can be altered in different ways, then saved.

Embroidery motifs can either be saved in the embroidery computer memory or on a USB Stick.



Embroidery motifs which were altered in size and saved are regarded as new motifs when they are recalled. That is why all percentages say 100%, and the former alteration can no longer be seen.

## Embroidery computer memory

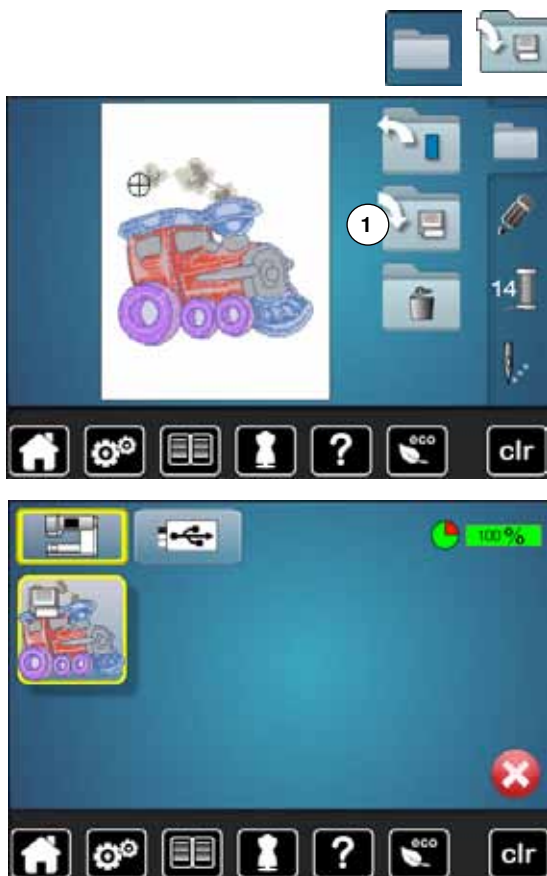

- select desired motif
- alter if desired
- press «Selection»-button
- touch «Save»-icon 1

The motif to be saved is displayed in a yellow frame.

- ▶ «Embroidery computer»-icon is active
- ▶ the «My Designs» folder is opened automatically
- ▶ the system memory capacity (free capacity) is displayed in percent (%) in the green bar
- select the motif to be saved
- ▶ the embroidery motif is saved in numerical order in the «My Designs» folder
- ▶ the «Edit»-display appears again

## USB stick



The motif to be saved is displayed in a yellow frame.

- insert USB stick
- touch «USB stick»-icon
- ▶ the system memory capacity (free capacity) is shown in percentage (%) in the green bar
- select the motif to be saved
- ▶ the motif is saved on the stick



Empty USB sticks are available as optional accessory at the BERNINA-dealer.  
Sticks of other brands are unlikely to be supported, especially sticks providing a large memory capacity.

## Overwriting motifs

Saved motifs in the memory or on an USB Stick can be overwritten directly by another motif.

- select desired motif



- insert BERNINA USB-Stick
- press «Selection»-button
- touch «Save»-icon



The motif to be saved is displayed in a yellow frame.

- touch «Embroidery computer»-icon or «USB-Stick»-icon
- select the motif to be overwritten



- confirm with ✓
- ▶ the motif is now saved at the previously selected position

## Deleting saved single motif



- insert USB stick
- touch «USB stick»-icon or
- touch «Embroidery computer»-icon or
- touch «My Design»-icon



- ▶ touch «Delete»-icon 1



- select the motif to be deleted



- confirm with ✓
- ▶ the motif is deleted

### Cancelling deleting

- touch ✗
- ▶ the deleting is cancelled, the previous screen appears

## Deleting all saved motifs

It is possible to delete the content of the folder «My Designs» or the USB stick all at once.



- press «Setup»-button
- touch «Basic settings»-icon
- touch «Delete user data»-icon



When embroidering there are two options to choose from:

- 1 My Designs
  - 2 USB stick (the stick must be inserted)
- touch the button of which the data should be deleted



- confirm with ✓
- ▶ the data is deleted

### Cancelling deleting

- touch ✗
- ▶ the deleting is cancelled, the previous screen appears



## Starting to embroider

### Select hoop



- select motif
  - ▶ the selected motif is displayed in the optimal (the smallest) hoop
  - ▶ the «Select hoop»-icon displays the recommended hoop
- attach the recommended hoop

### Attaching the embroidery hoop

- raise needle and embroidery foot
- hold the hoop with the right side of the fabric up and the attaching mechanism to the left

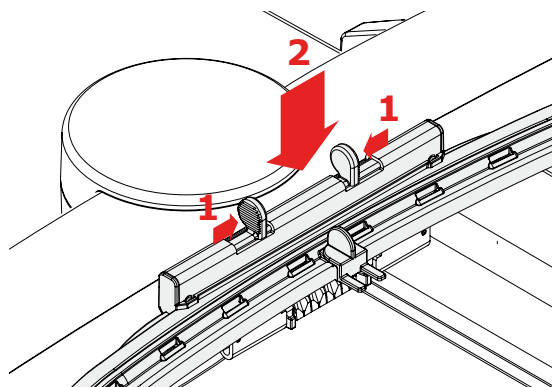

### Attach the hoop to the embroidery arm

- guide the hoop underneath the embroidery foot
- press the attaching mechanisms of the hoop toward each other
- position the center points of the hoop (small attachment clamps) over the bracket of the embroidery arm
- press down until it clicks in position
- release the attaching mechanism of the hoop

### Removing the hoop

- press both of the attaching mechanisms of the hoop toward each other
- lift the hoop up to remove



- press «Embroidery menu»-button or «Start/Stop»-button on the headframe
  - ▶ the hoop moves
  - ▶ the hoop is read



Calibrating the embroidery hoop see page 48.



As soon the «Embroidery menu»-button has been pressed, made alterationen will not be visible anymore when going back to the «Edit»-display. The «Information»-icon turns blue again, the function icons are no longer yellow-framed and the setting is at 100%.

## Embroidery menu



- ▶ embroidery menu is opened
- ▶ the motif is ready for embroidering

## Embroidering using the «Start/Stop»-button on the headframe



- press the «Start/Stop»-button on the headframe, until the embroidery computer starts
- ▶ the embroidery computer sews approximately 7 stitches and stops automatically
- ▶ a Display indicates that the thread tail has to be cut at the beginning of the motif
- raise the presser foot
- cut the thread tail at the beginning of motif
- lower the presser foot
- press the «Start/Stop»-button on the headframe and continue embroidering

### Interrupting the process

- press «Start/Stop»-button on the headframe
- ▶ the embroidery computer stops

### Completing the color

- press «Start/Stop»-button on the headframe
- ▶ the embroidery computer embroiders all the sections in the color activated
- ▶ the embroidery computer stops automatically when complete
- ▶ both threads are automatically cut

### Changing color

- ▶ the embroidery computer switches automatically to the next color
- change color of the upper thread accordingly
- embroider with the new color



### «Embroidery»-display

- ▶ after starting the motif the «Embroidery»-display appears

## Embroidering with foot control

When embroidering with the foot control always keep it depressed.

- press the foot control
- ▶ the embroidery computer sews approximately 7 stitches and stops automatically
- ▶ a Display indicates that the thread end has to be cut after the start of embroidering
- release the foot control
- raise the presser foot
- cut the thread tail at the beginning of motif
- lower the presser foot
- press the foot control and continue embroidering

### Interrupting with the foot control

- release the foot control
- ▶ the sewing computer stops

### Completing the color

- press the foot control
- ▶ the embroidery computer embroiders all the sections in the color activated
- ▶ the embroidery computer stops automatically when complete
- ▶ both threads are automatically cut

### Changing color

- ▶ the embroidery computer switches automatically to the next color
- change color of the upper thread accordingly
- embroider with the new color



### «Embroidery»-display

- ▶ after starting the motif the «Embroidery»-display appears



Embroidering via the foot control is recommended to embroider a small sequence.

## Thread breakage when embroidering

The upper or lower thread may occasionally run out or break when you are embroidering. When this happens, the embroidery computer stops automatically, provided that the thread and bobbin indicators are activated in the setup program.

### Upper or lower thread breaks



- ▶ the embroidery computer stops automatically
- ▶ an animation is displayed
- check upper thread
- rethread needle
- check lower thread
- refill or rethread bobbin

### Embroidery sequence control when thread breaks



- touch «Thread breakage»-icon

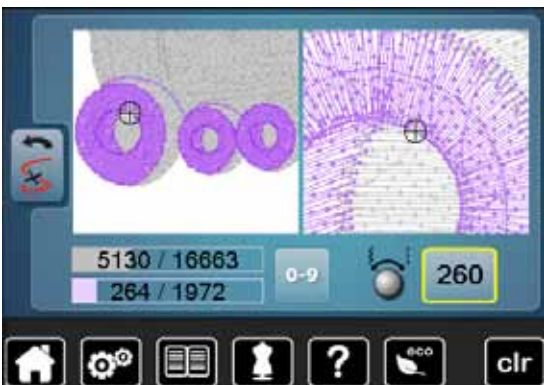

In the left portion of the Display the active color of the motif is shown in original size and in the right portion enlarged. This makes it easier to check the embroidery sequence.

- ▶ the message to operate the stitch width and stitch length knobs appears
- turn the knobs to the left or to the right
- ▶ the hoop moves along the embroidery sequence backwards or forwards
- turn the stitch width knob slowly
- ▶ the hoop is moved stitch by stitch
- turn the stitch length knob slowly
- ▶ the hoop is moved in big steps
- ▶ the number in the yellow-framed icon indicates the current position within the motif by stitch number
- via the «0-9»-icon a position can be entered directly
- position the needle back far enough so that it will resume stitching several stitches before the thread breakage

#### Returning to original position

- touch «Back»-icon
- ▶ the Display is closed

#### Resuming embroidering

- press «Start/Stop»-button or the foot control



## Cleaning

### ATTENTION!

Disconnect plug from the socket before cleaning or lubricating!  
Never use alcohol, petrol, white spirit or any type of solvent to clean the sewing computer!

#### Cleaning the Display and the sewing computer

Wipe with a soft, damp cloth.



#### Feed dog area

Clean the sewing computer after every use - remove any lint from under the stitch plate and in the hook area.

- turn power switch to «0» (off)
- remove plug from electrical outlet
- remove presser foot and needle
- open the bobbin door
- press the stitch plate down at the right back corner until it flips up
- remove the stitch plate
- clean the area with the lint brush
- replace the stitch plate

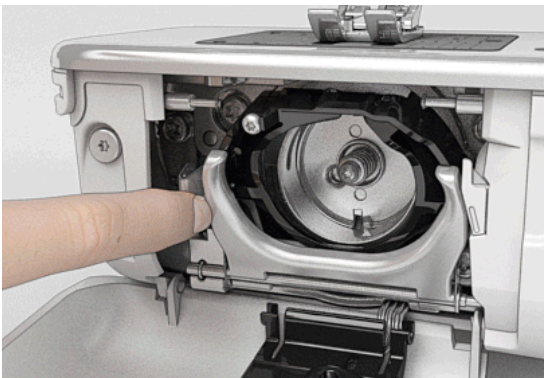

#### Cleaning the hook

- turn power switch to «0» (off)
- remove plug from electrical outlet
- remove bobbin case
- push release lever to the left
- flap down fastening bracket along with the black hook race cover
- remove the hook

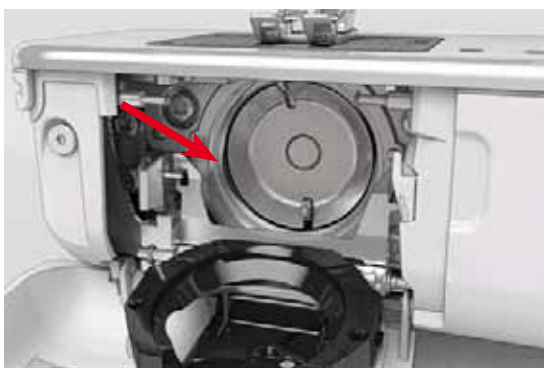

- clean the hook race; do not use any pointed objects
- hold the hook at the pin in the center with two fingers
- lead the hook, lower edge ahead, angular top-down behind the hook race cover
- position the hook with the two lugs meeting the openings in the hook, the colored mark on the hook driver should be visible through the hole in the hook
- insert the hook
- ▶ the hook is magnetic and therefore fastened to correct position
- close the hook race cover and the fastening bracket, release bracket must engage
- as a check, turn the handwheel
- insert the bobbin case

### Lubricating the Sewing Computer

It is important to lubricate the sewing computer regularly.



### Lubricating

- turn power switch to «0» (off)
- remove plug from electrical outlet
- remove the stitch plate
- refill the oil depot using BERNINA-oil
- replace the stitch plate

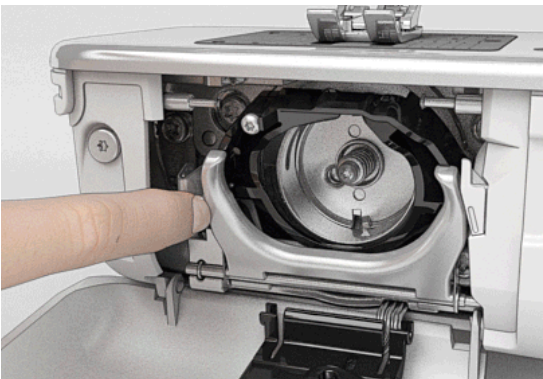

- remove bobbin case
- press release bracket to the left
- flap down the fastening bracket along with the black hook race cover
- remove the hook



- fill as much BERNINA-oil into both oil depots so that the felts are damp
- insert the hook
- close hook race cover and fastening bracket, release bracket must engage
- as a check, turn the handwheel
- insert the bobbin case
- close the bobbin cover

### ATTENTION!

To provide a good sewing quality, the surface of the hook sleeve (marked in red) MUST remain free of oil. Otherwise clean with a cloth.

## Troubleshooting

In most cases you will be able to identify and remedy faults by checking the following.









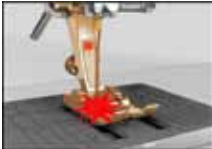

### Check if:

- the upper and lower threads are threaded correctly
- the needle is inserted correctly
- the needle size is correct - check the needle/thread table page 16
- the needle tip and shaft are undamaged
- the sewing computer is clean - brush out any thread lint
- the hook race is clean
- any threads are trapped between the tension discs or under the bobbin case spring

Fault	Cause	Repair
<b>Uneven stitch formation</b>	<ul style="list-style-type: none"> <li>– Upper thread too tight/too slack</li> <li>– Needle blunt or bent</li> <li>– Poor quality needle</li> <li>– Poor quality thread</li> <li>– Needle/thread combination is incorrect</li> <li>– Incorrectly threaded</li> </ul>	<ul style="list-style-type: none"> <li>• reduce/increase upper thread tension</li> <li>• use new BERNINA quality needle</li> <li>• use new BERNINA quality needle</li> <li>• use quality thread (Isacord, Mettler, Gütermann etc.)</li> <li>• match the needle to the thread size</li> <li>• check upper and lower thread</li> </ul>
<b>Skipped stitches</b>	<ul style="list-style-type: none"> <li>– Incorrect needle system</li> <li>– Needle bent or blunt</li> <li>– Poor quality needle</li> <li>– Needle inserted incorrectly</li> <li>– Incorrect needle point</li> </ul>	<ul style="list-style-type: none"> <li>• use needle system 130/705H</li> <li>• use new BERNINA quality needle</li> <li>• use new BERNINA quality needle</li> <li>• insert needle as far up as it will go</li> <li>• match the needle point to the texture of the material</li> </ul>
<b>Faulty stitching</b>	<ul style="list-style-type: none"> <li>– Remnants of thread between the tension discs</li> <li>– Incorrectly threaded</li> <li>– Remnants of thread under the bobbin case spring</li> </ul>	<ul style="list-style-type: none"> <li>• fold a piece of thin material and slide the folded edge (not the raw edges) between the thread tension discs, moving the material back and forth to clean the right and left side of the thread tension</li> <li>• check upper and lower thread</li> <li>• carefully remove any thread remnants from under the spring</li> </ul>
<b>Thread is caught in the area of the take-up lever</b>	<ul style="list-style-type: none"> <li>– Upper thread breaks</li> </ul> 	<p>If the upper thread breaks and the thread is trapped in the area of the take-up lever, proceed as follows:</p> <ul style="list-style-type: none"> <li>• turn power switch to «0» (off)</li> <li>• remove the screw 1 on the headframe with the angular Torx wrench</li> <li>• pull the headframe at the bottom slightly forward, flip it upwards a bit and remove it</li> <li>• remove remnants of thread</li> <li>• attach headframe and retighten screw</li> </ul>
<b>Upper thread breaks</b>	<ul style="list-style-type: none"> <li>– Incorrect needle/thread combination</li> <li>– Upper thread tension too tight</li> <li>– Incorrectly threaded</li> <li>– Poor-quality or old thread</li> <li>– Stitch plate or hook tip damaged</li> </ul>	<ul style="list-style-type: none"> <li>• match the needle according to the thread</li> <li>• reduce upper thread tension</li> <li>• check upper threading</li> <li>• use quality thread (Isacord, Mettler, Gütermann etc.)</li> <li>• take the sewing computer to the nearest authorized BERNINA dealer</li> </ul>
<b>Lower thread breaks</b>	<ul style="list-style-type: none"> <li>– Lower thread tension too tight</li> <li>– Stitch hole in the stitch plate has been damaged</li> <li>– Needle blunt or bent</li> </ul>	<ul style="list-style-type: none"> <li>• increase the upper thread tension</li> <li>• take the sewing computer to the nearest authorized BERNINA dealer</li> <li>• use new needle</li> </ul>

Fault	Cause	Repair
<b>Needle breaks</b>	<ul style="list-style-type: none"> <li>– Needle not correctly inserted</li> <li>– Fabric was pulled</li> <li>– Fabric was pushed when using thick material</li> <li>– Poor-quality thread, unevenly wound or knotted</li> </ul>	<ul style="list-style-type: none"> <li>• tighten the needle clamp screw</li> <li>• do not pull the fabric during sewing</li> <li>• use the correct presser foot for thick material (e.g. Jeans foot No. 8) use height compensating tool when sewing over a thick seam</li> <li>• use quality thread (Isacord, Mettler, Gütermann etc.)</li> <li>• always remove the hook after a needle breakage and check the magnetic back of the hook for broken off needle parts</li> </ul>
<b>Display is inactive</b>	<ul style="list-style-type: none"> <li>– Calibration data incorrect</li> <li>– ECO-function active</li> </ul>	<ul style="list-style-type: none"> <li>• re-calibrate the Display in the Setup Program</li> <li>• turn off ECO function</li> </ul>
<b>Stitch width not adjustable</b>	<ul style="list-style-type: none"> <li>– Setting activated in the security program</li> </ul>	<ul style="list-style-type: none"> <li>• deactivate setting</li> </ul>
<b>Sewing-/Embroidery computer</b>	<ul style="list-style-type: none"> <li>– Sewing computer fails to run or runs slowly</li> <li>– Turn power switch to «0» (off)</li> </ul>	<ul style="list-style-type: none"> <li>• check the setting in the Setup Program</li> <li>• alter the speed control</li> <li>• place the sewing computer in a warm room one hour before use</li> <li>• turn the power switch to «I» (on)</li> <li>• take the sewing computer to the nearest authorized BERNINA dealer</li> </ul>
<b>Upper thread indicator does not respond</b>	<ul style="list-style-type: none"> <li>– Not activated in the Setup Program</li> </ul>	<ul style="list-style-type: none"> <li>• activate in the Setup Program</li> </ul>
<b>Lower thread indicator does not respond</b>	<ul style="list-style-type: none"> <li>– Not activated in the Setup Program</li> </ul>	<ul style="list-style-type: none"> <li>• activate in the Setup Program</li> </ul>
<b>Lower thread indicator reacts</b>	<ul style="list-style-type: none"> <li>– Thread used/broken</li> </ul>	<ul style="list-style-type: none"> <li>• wind thread and thread</li> </ul>
<b>Update error</b>	<ul style="list-style-type: none"> <li>– USB stick is not recognized</li> <li>– Update process is blocked (hourglass stays on Display)</li> <li>– Update-data aren't identified</li> </ul>	<ul style="list-style-type: none"> <li>• use a BERNINA USB stick</li> <li>• remove the stick and turn the sewing computer off and on again. Proceed with the update as indicated by the message</li> <li>• don't save update-data in a folder</li> <li>• unzip update-data</li> </ul>
<b>LED sewing light do not light up</b>	<ul style="list-style-type: none"> <li>– LED defective</li> <li>– Deactivated in the Setup-Program</li> </ul>	<ul style="list-style-type: none"> <li>• take the sewing-/embroidery computer to the nearest authorized BERNINA dealer</li> <li>• activate in the Setup Program</li> </ul>
<b>General Messages</b>	<b>Explanation</b>	<b>Repair</b>
<b>Sewing-/Embroidery computer</b>	<ul style="list-style-type: none"> <li>– Deleting or overwriting data, e.g. drawers</li> </ul>	<ul style="list-style-type: none"> <li>• confirm with ✓ or cancel with ✗</li> </ul>
	<ul style="list-style-type: none"> <li>– Stitch number not known in direct entry</li> </ul>	<ul style="list-style-type: none"> <li>• check command entered and enter a new number</li> </ul>
	<ul style="list-style-type: none"> <li>– Stitch selection not possible in the combination mode</li> </ul>	<ul style="list-style-type: none"> <li>• make another selection</li> </ul>

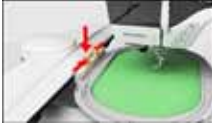

General Messages	Explanation	Repair
	– Lower feed dog	• press the «Feed dog»-button. The feed dog is lowered
	– Incorrect needle for the stitch plate selected	• check settings in securing program
	– Needle is not in the highest position	• turn handwheel
	– Upper thread used up	• attach new upper thread spool and thread
	– Lower thread indicator has reacted	• check lower thread and wind if necessary
	– Main motor is not running	• check hook system. Remove any thread lint from the hook area/bobbin case • remove the hook and check the magnetic back of the hook for broken off needle parts
	– Needle position doesn't correspond to center of hoop	• adjust according to User Instructions page 48
	– Needle position doesn't correspond to center of hoop	• adjust according to User Instructions page 48
	– Embroidery module has not been attached yet – Embroidery module has not been correctly attached	• connect the embroidery module to the sewing computer • check the embroidery module connection
	– No embroidery hoop attached	• attach embroidery hoop
	– Because of vibrations the contact between the embroidery computer and the module is interrupted.	• attach the module again and switch the embroidery computer off and on again

**General Messages**

**Explanation**

**Repair**

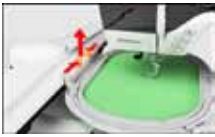

– Embroidery hoop attached

• remove embroidery hoop

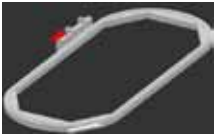

– The embroidery process cannot proceed

• move Mega-Hoop to center position and resume embroidering

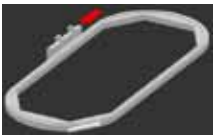

– Embroidery motif is partly outside the hoop

• re-position the embroidery motif. The area within the hoop can be embroidered



– Embroidery motif is too large

• reduce the motif size or attach a bigger hoop. The area within the hoop can be embroidered

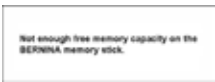

– Less free space on the USB stick

• delete data from USB stick



– No personal data available on the USB stick

• check that the USB stick is inserted correctly and re-start the sewing computer

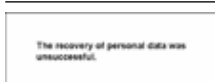

– During the update process personal data was not saved on the USB stick

• the software was correctly updated. Personal data could not be recovered

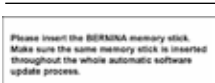

– BERNINA USB stick is not inserted

• insert BERNINA USB stick and do not remove during the update process

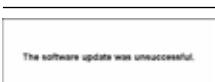

– New SW Version is not available on the stick

• save the new SW Version on the BERNINA USB stick and start the update again

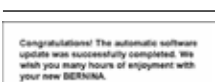

– Update successful

• the sewing-/embroidery computer has been provided with the latest software version

**General Messages**

**Explanation**

**Repair**



– The sewing computer must be cleaned/lubricated

• when this message appears, the sewing computer must be cleaned/lubricated. This ensures proper functioning and a long operational life span of the sewing computer

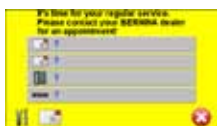

– It is time for the regular maintenance. Please contact your BERNINA dealer or your BERNINA service address

• the sewing-/embroidery computer must be taken to an authorised BERNINA dealer/servicing shop. The announcement appears after completing the programmed service interval. The message can be deleted temporarily by touching the field «ESC» but will reappear when the sewing-/embroidery computer is next restarted. Having cleared the announcement via the «ESC» three times, the announcement will appear as recently as the next service interval has been completed. Having your sewing/embroidery computer cleaned and serviced properly at the appropriate times ensures its proper functioning and long service life. Failure to do so may adversely affect service life and limit the guarantee. The charge for servicing is nationally regulated – consult your dealer or servicing shop for details

## Overview Stitch patterns

### Practical stitches

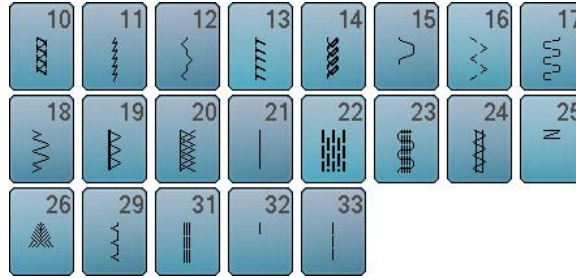
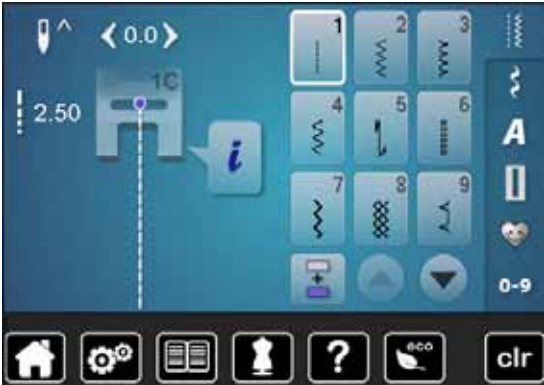

### Buttonholes



### Decorative stitches

#### Florals



# Stitch patterns

## Cross stitches

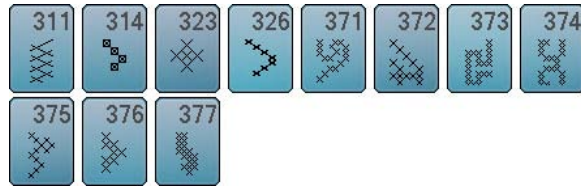

## Satin stitches

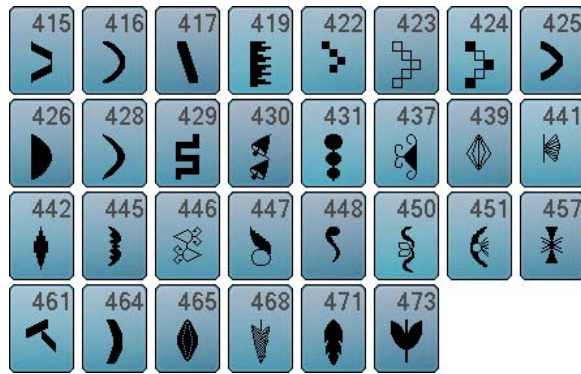

## Ornamental stitches

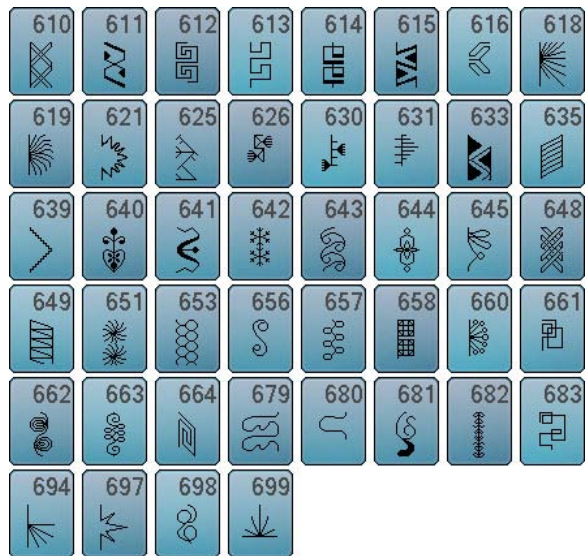

### Heirloom stitches

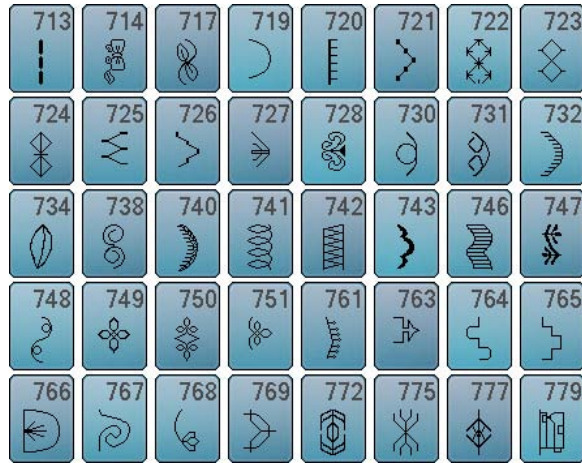

### Novelty Stitches



### Quilt stitches



## Alphabets Block



P	Q	R	S	T	U	V	W
X	Y	Z	Ä	À	Â	Å	Æ
Ç	È	É	Ê	Ë	Ö	Œ	Ø
Ü	1	2	3	4	5	6	7
8	9	0	-	-	.	'	!
+	=	&	÷	?	%	@	(
)	[	]					



p	q	r	s	t	u	v	w
x	y	z	ä	à	â	å	æ
ç	è	é	ê	ë	ö	œ	ø
ü							

## Double-Block



P	Q	R	S	T	U	V	W
X	Y	Z	Ä	À	Â	Å	Æ
Ç	È	É	Ê	Ë	Ö	Œ	Ø
Ü	1	2	3	4	5	6	7
8	9	0	-	-	.	'	!
+	=	&	÷	?	%	@	(
)	[	]					



p	q	r	s	t	u	v	w
x	y	z	ä	à	â	å	æ
ç	è	é	ê	ë	ö	œ	ø
ü							

Script

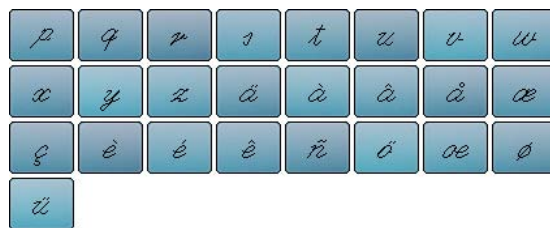
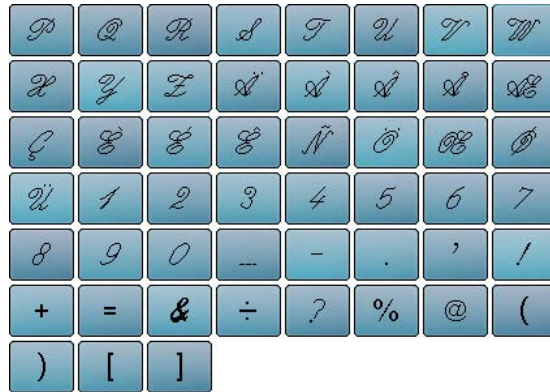

Quilting Text

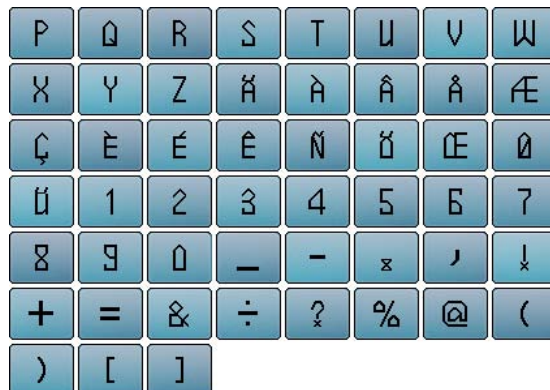



Stitch patterns

Cyrillic



О	П	Р	С	Т	У	Ф	Х
Ц	Ч	Ш	Щ	Ъ	Ы	Ь	Э
Ю	Я	Ө	Ғ	Қ	Ң	Ө	Ұ
Ү	Һ	І	Ҫ	Ј	Љ	Њ	Ћ
Џ	Ґ	Є	Ї	Ў	Ё	Ѓ	Ѕ
Ў	Й	1	2	3	4	5	6
7	8	9	0	-	-	•	'
!	+	=	&	÷	?	%	@
(	)	[	]				



о	п	р	с	т	у	ф	х
ц	ч	ш	щ	ъ	ы	ь	э
ю	я	ө	ғ	қ	ң	ө	ұ
ү	һ	і	җ	ј	љ	њ	ћ
џ	ґ	є	ї	ў	ё	ѓ	ѕ
ў	й						

Hiragana





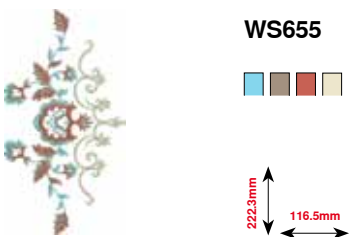
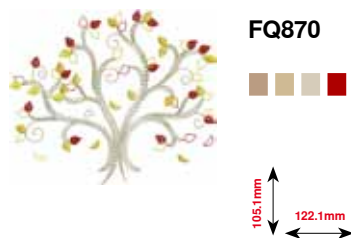
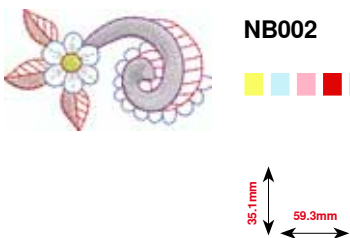
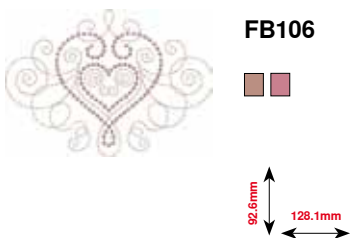
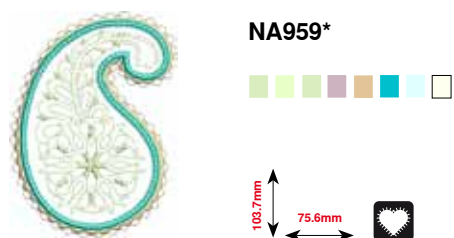
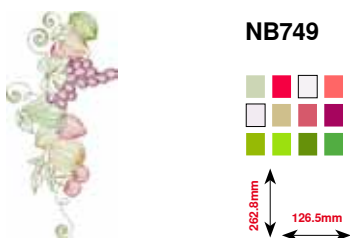
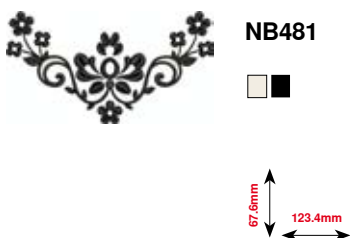
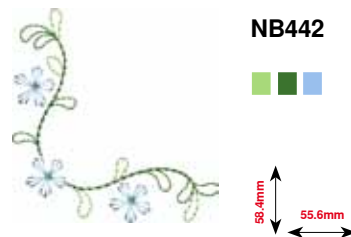
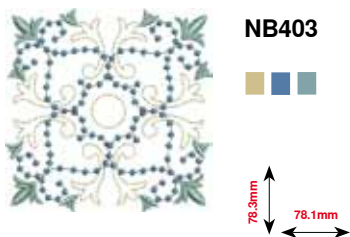

た	ち	つ	て	と	な	に	ぬ
ね	の	は	ひ	ふ	へ	ほ	ま
み	む	め	も	や	ゆ	よ	ら
り	る	れ	ろ	わ	を	ん	あ
い	う	え	お	ゃ	ゅ	ょ	っ
が	ぎ	ぐ	げ	ご	ざ	じ	ず
ぜ	そ	だ	ち	づ	で	ど	ば
び	び	べ	ぼ	ぱ	び	び	べ
ぼ	1	2	3	4	5	6	7
8	9	0	-	-	•	?	!
•	,	「	」	『	』		

# Overview Motifs

## Embellishment



-  Free Standing Lace
-  Basic CutWork
-  Fringes
-  Application

\* This design has special effects. For more information please go to [www.bernina.com/7series](http://www.bernina.com/7series)

Quilting



**BD569**

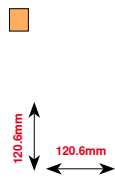

**BD394**

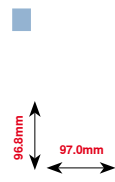

**BD412**

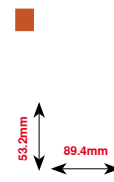

**BD513**

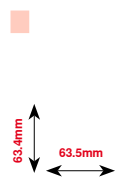

**BD514**

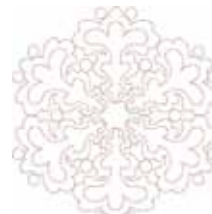
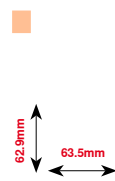

**BD553**

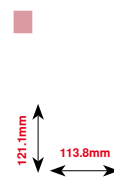

**BD554**

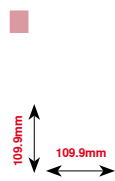

**BD567**

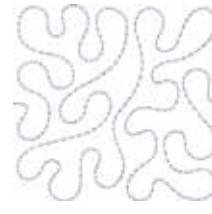

**BD501**

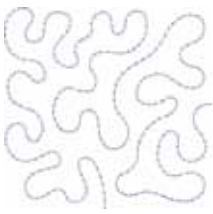
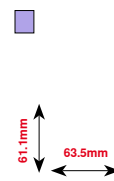

**BD502**

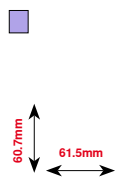

Borders and Lace

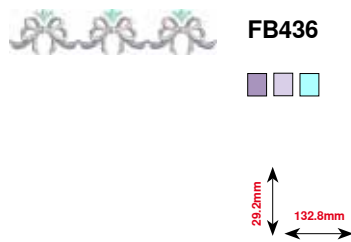
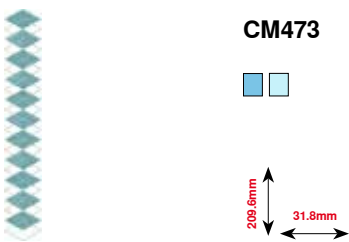
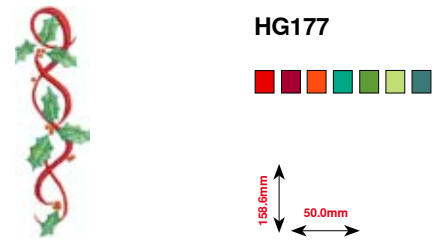
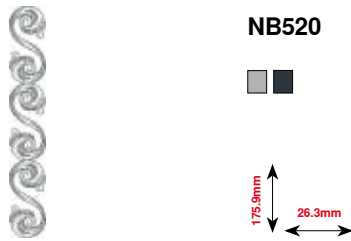
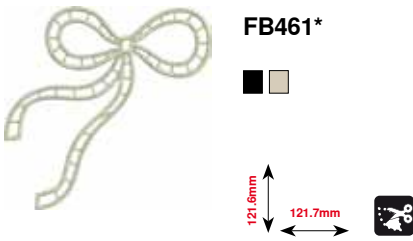
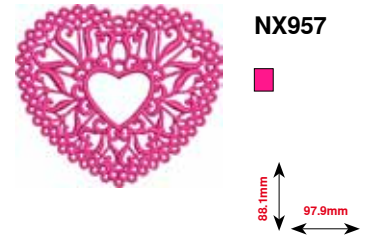
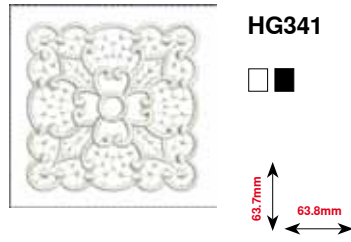
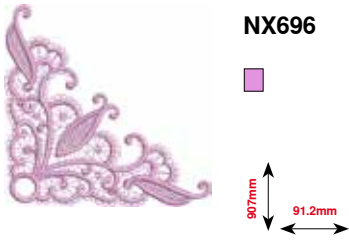

\* This design has special effects. For more information please go to [www.bernina.com/7series](http://www.bernina.com/7series)

Children



CK970



81.6mm  
84.4mm



CK738



85.7mm  
89.1mm



NB193



96.2mm  
113.3mm



CM193\*



127.4mm  
106.7mm



CM220\*



71.8mm  
71.5mm



CM362\*



119.0mm  
120.6mm



CM376\*



97.5mm  
100.3mm



CM348



167.1mm  
119.0mm



CK511



64.6mm  
76.2mm



CK667\*



82.3mm  
99.8mm



\* This design has special effects. For more information please go to [www.bernina.com/7series](http://www.bernina.com/7series)

Seasons



HG053

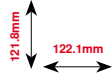

NB317

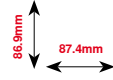

HE919

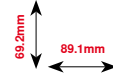

HG319

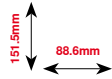

CM426

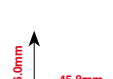

CM287

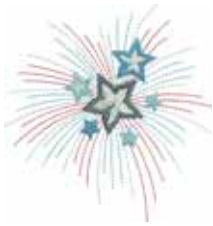
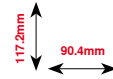

HG460

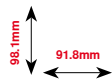

FQ749

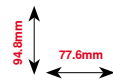

Sports and Hobbies



SR589

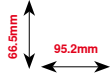

LT870

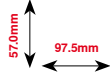

RC244

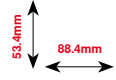

SP980

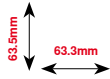

SP989

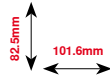

SR067

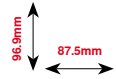

FB148

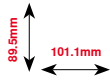

SR551

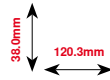

Animals



CM142



66.7mm  
56.5mm



FQ624



144.2mm  
64.5mm



WP224



111.0mm  
100.4mm



WP192



81.0mm  
98.9mm



WS610



111.1mm  
127.3mm



LJ599



98.0mm  
93.2mm



WP325



94.0mm  
77.9mm



FQ617



198.3mm  
118.0mm



Flowers



**NB209**

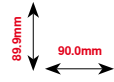

**FQ722**

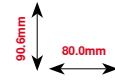

**FQ733**

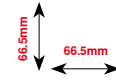

**FB492**

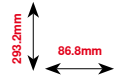

**FP814**

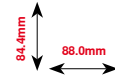

**FP246**

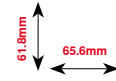

**FQ562**

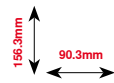

**FQ801**

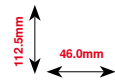

## Alphabets

## Swiss Block

ABCDEFGHIJKLMN  
 OPQRSTUVWXYZ  
 abcdefghijklmn  
 opqrstuvwxyz  
 1234567890  
 @#&\$;-)  
 ÀÇÉÏÕÚÆ  
 àçéïõûæ

## Anniversary

*ABCDEFGHIJKLMN  
 OPQRSTUVWXYZ  
 abcdefghijklmn  
 opqrstuvwxyz  
 1234567890  
 @#&\$;-)  
 ÀÇÉÏÕÚÆ  
 àçéïõûæ*

## Guinevere

ABCDEFGHIJKLMN  
 OPQRSTUVWXYZ  
 abcdefghijklmn  
 opqrstuvwxyz  
 1234567890  
 @#&\$;-)  
 ÀÇÉÏÕÚÆ  
 àçéïõûæ

## Drifter

**ABCDEFGHIJKLMN  
 OPQRSTUVWXYZ  
 abcdefghijklmn  
 opqrstuvwxyz  
 1234567890  
 @#&\$;-)  
 ÀÇÉÏÕÚÆ  
 àçéïõûæ**

## Index

### A

#### Accessory

- Embroidery 123
- Presser feet 10
- Sewing 9-11
- Storage example 11

#### Accessory box 11

#### Adjusting

- Needle position 31, 35, 39, 40, 67
- Presser foot pressure 27
- Upper thread tension 26

#### Air vents 13

#### Alphabets

- Altering letter size 111
- Combining Lettering 110
- Correcting the combination 110
- Correction 147
- Deleting lettering 110
- Functions 38, 111
- Kinds of alphabets 109
- Lettering 109
- Main display/Menu selection 32
- Overview 109, 135
- Perfect Stitch Formation 109
- Selecting 109, 134
- Upper-/lower case lettering 111
- With functions 111

#### Altering

- Audio settings 49
- Brightness 45
- Display settings 45
- Embroidery settings 48
- Presser foot pressure 27
- Sewing light 45
- Upper thread tension 26, 46, 143
- Welcome text 45
- Winder speed 50

#### Altering embroidery settings 48

#### Altering pattern length 34

#### Altering stitch

- Length 67
- Width 67

#### Altering stitch density 35

#### Altering stitch length 67

#### Altering stitch width 67

#### Altering winding speed 44, 50

#### Attaching

- BSR presser foot sole 103
- Embroidery hoop 124, 160
- Embroidery module 128
- Presser foot 24
- Presser foot lifter 19
- Slide-on table 18
- Stitch plate 25

#### Audio settings

- Altering 49
- BSR 49
- Function 49
- Stitch patterns 49

### B

#### Back-icon 34, 138

#### Balance

- Buttonhole 84
- Correcting 59
- Eyelet roundness 94
- Glossary 8
- Practical- and decorative stitches 59
- Reset to basic setting 59

#### Basic setting

- Embroidery settings 48
- Presser foot pressure 27
- Sewing settings 44, 46-47
- Thread tension 26

#### Basting stitch 63, 77

#### BERNINA Dual Transport 107-108

#### Bobbin case

- Inserting/removing 21

#### Bobbin cover 13

#### Bobbin winder pre-tension 13, 20

#### Brightness 45

#### BSR 102-106

- Attaching the presser foot to the sewing computer 103
- Beeper/Tonwahl 105
- Display 103
- Functions 104
- Modes 102
- Needle stop 104
- Preparation 103
- Removing/attaching presser foot sole 103
- Securing 104
- Starting/Leaving 106
- With straight stitch No. 1 102
- With zig-zag stitch No. 2 102, 106

#### Button sew-on program 80, 93

- |   |               |  |                |
|---|---------------|--|----------------|
| <b>Buttonhole</b>                                   | <b>80-94</b>  | <b>Combi mode</b>  | <b>116-120</b> |
| • 5-steps, manual                                   | 92            | • Correcting stitch pattern combination                            | 118            |
| • 7-steps, manual                                   | 92            | • Creating stitch pattern combination                              | 116            |
| • Adjusting the bead width                          | 81            | • Deleting stitch patterns   | 117            |
| • Altering stitch length                            | 81            | • Opening saved combination  | 117            |
| • Automatic   | 85-89         | • Overwriting stitch pattern combination                           | 120            |
| • Automatic buttonhole foot No. 3A                  | 10, 51, 85-89 | • Programming practical stitches/decorative stitches/<br>alphabets | 116            |
| • Automatic round and keyhole buttonhole            | 87            |  |                |
| • Balance   | 84            | <b>Combination</b>   | <b>40-43</b>   |
| • Button sew-on program                             | 80, 93        | • Combination repeat   | 43             |
| • Cording   | 83            | • Combination subdivider (1)                                       | 42             |
| • Cutting open                                      | 83            | • Combination subdivider (2)                                       | 42             |
| • Decorative buttonhole                             | 80            | • Deleting single stitch pattern                                   | 40             |
| • Decorative buttonhole with double pointed bartack | 88            | • Deleting the whole combination                                   | 43             |
| • Duplicating                                       | 85            | • Mirror image left/right  | 43             |
| • Eyelets   | 80, 94        | • Securing   | 42             |
| • Feed support                                      | 81            |  |                |
| • Height compensation tool                          | 81            | <b>Compensating material</b>                                       | <b>79, 81</b>  |
| • Heirloom buttonhole                               | 80, 89        |  |                |
| • Important Information                             | 81            | <b>Compensation</b>  |                |
| • In long term memory                               | 90-91         | • Height of seam   | 79             |
| • Keyhole buttonhole                                | 80            | • Layers   | 79             |
| • Manual  | 92            |  |                |
| • Marking   | 81            | <b>Connecting stitches</b>   | <b>127</b>     |
| • Narrow buttonhole                                 | 80            |  |                |
| • Overview  | 80            | <b>Connection</b>  |                |
| • Programming                                       | 85-89         | • BSR  | 13, 103        |
| • Round buttonhole with normal bartack              | 80            | • Embroidery module  | 124            |
| • Stabilizer and interfacing                        | 82            | • Foot control   | 13, 18         |
| • Standard and stretch buttonhole                   | 85            | • Optional accessory   | 13             |
| • Standard buttonhole                               | 80            | • PC for embroidery software                                       | 13, 18         |
| • Stitch counter buttonhole                         | 89            | • Power cable  | 13, 18         |
| • Straight stitch buttonhole                        | 80            | • Presser foot lifter  | 13, 19         |
| • Stretch buttonhole                                | 80            | • USB  | 13, 18         |
| • Test-sewing                                       | 81            |  |                |
| • With direct length entry                          | 86            | <b>Contents</b>  |                |
|   |               | • Embroidery   | 121-122        |
|   |               | • Sewing   | 4-6            |
| <b>C</b>  |               | <b>Cording</b>   |                |
|   |               | • Automatic buttonhole foot No. 3A                                 | 83             |
| <b>Cable</b>  |               | • Buttonholefoot No. 3C  | 83             |
| • Connection  | 13, 18        | • Fixing   | 83             |
| • Plugging in                                       | 18            | <b>Correcting</b>  |                |
| • Unwinding/winding                                 | 18            | • Practical-/decorative stitches                                   | 59             |
| <b>Calibrating</b>                                  |               | <b>Cover</b>   |                |
| • Automatic buttonhole foot No. 3A                  | 51            | • Thread take-up lever   | 13, 22         |
| • Display   | 49            | <b>Creative consultant</b>   |                |
| • Embroidery hoop                                   | 48            | • Leaving  | 57             |
| <b>Carrying handle</b>                              | <b>13</b>     | • Overview   | 57             |
|   |               | • Recommendations  | 57             |
| <b>Changing</b>                                     |               | • Sewing techniques  | 57             |
| • Bobbin case                                       | 21            | • Types of fabric  | 57             |
| • Needle  | 22            |  |                |
| • Presser foot                                      | 24            | <b>D</b>   |                |
| • Stitch plate                                      | 25            |  |                |
| <b>Cleaning</b>                                     |               | <b>Darning</b>   |                |
| • Display and Sewing Computer                       | 164           | • Automatic  | 72-73          |
| • Feed dog area                                     | 164           | • Manual   | 71             |
| • Hook  | 164           |  |                |
| • Lubricating                                       | 165           |  |                |

- Darning and embroidery thread** 125
- Darning hoop connection** 13
- Dealer details** 54
- Decorative stitches**
- Application 95
  - Categories 95
  - Cross stitch 96
  - Overview 95
  - Pin tucks 97
  - Selecting 95
  - Sewing lower thread 98
- Deleting**
- Stitch patterns 138, 139, 145, 158, 159
  - Stitch patterns 40, 43, 117, 120
  - User data 52, 159
- Details**
- Accessory 9-11, 123
  - Embroidery module 124
  - Sewing computer 12-13
- Display**
- Alphabets 32, 38-39, 109
  - Altering settings 45-54
  - Balance 59
  - BSR 103
  - Buttonholes 36-37, 80
  - Calibrating 49
  - Combi mode 40-43
  - Creative consultant 57
  - Decorative stitches 95
  - Edit 138
  - Embroidery Alphabet 135
  - Embroidery mode 134
  - Functions 34-43
  - Help program 58
  - Main display 32-33, 134-137
  - Menu selection 32
  - Overview 32-43, 134-140
  - Practical stitches 62
  - Quilt stitches 99
  - Selecting the color 46
  - Selection 32-33
  - Setup 44-54
  - Sewing 32-33
  - Stitch pattern area 33
  - Stitch pattern display 33
  - Tutorial 55-56
- Dual Transport** 107-108
- E**
- 
- eco** 13, 32, 60
- Edit**
- Altering embroidery motif proportionally 139
  - Color number 138
  - Deleting embroidery motif 139
  - Display 138
  - Embroidery menu 138
  - Mirror image left/right 139
  - Mirror image up/down 139
  - Moving embroidery motif 139
  - Moving the view of the motif within the embroidery hoop 138
  - Overview 138
  - Rotating embroidery motif 139
  - Selection 138
  - Zoom minus 138
  - Zoom plus 138
- Embroidery** 121-163
- Alphabet 135
  - Embroidery motifs 136
  - Menu 161
  - Start 160
  - Thread breakage 163
  - Via Foot control 162
  - Via the «Start/Stop»-button 161
- Embroidery computer**
- «Function»-buttons 133
  - Embroidery needle 123, 125, 129
  - Embroidery threads 125
  - Entry in embroidery mode 134
  - Lowering the feed dog 129
  - Memory 155
  - Preparation 129
  - Straight-/CutWorkstichplatte 129
- Embroidery hoop**
- Adjusting 48
  - Basting box 144, 154
  - Center determination 130
  - Hoop selection/-display 140
  - Hooping material 130
  - Motif center 140
  - Moving 144
  - Parking the embroidery module 140
  - Selection 48, 123, 140, 151, 160
  - Using the hoop 130
  - Virtual positioning 140
- Embroidery menu**
- Color information bar 142
  - Color number 143
  - Cutting connecting stitches 143
  - «Embroidery menu»/«Start/Stop»-button 143
  - Edit 143
  - Overview 142
  - Presser foot indicator 142
  - Security program 142
  - Selection 143
  - Single- or multi-colored motif 143
  - Thread breakage 143
  - Upper thread tension 143
- Embroidery module**
- Attaching 128
  - Detail view 124
  - Overview 124
  - Parking 128, 140
  - Removing 128

- Embroidery motifs**
- Altering proportionally 139, 149
  - Altering thread brand 146, 153
  - By BERNINA 136, 148
  - Check 151
  - Colors 153
  - Deleting 139, 145
  - From USB-Stick 137
  - Lettering 135, 138-139
  - Mirror image 139, 150
  - Motif center 150
  - Motif size and embroidery time 152
  - Moving 139, 149
  - Moving the view of the motif 138, 152
  - Opening 145
  - Overwriting 157
  - Rotating 139, 149
  - Saving 145, 155-156
  - Scaling/sizing 126
  - Selecting 134, 143, 145
  - Single- or multi-colored 143, 154
  - Zoom 138, 152
- Embroidery template 130**
- Embroidery test 126**
- Embroidery threads**
- Lower threads 125
  - Metallic threads 125
  - Polyester threads 125
  - Rayon threads 125
- Embroidery-/Sewing computer**
- Cleaning 164-165
  - Lubricating 165
  - Overview 12-13, 124
  - Troubleshooting 166-170
- Entry**
- Embroidery mode 134
  - Sewing mode 134
- Environmental Protection 3**
- Examples of application**
- Decorative stitches 96-98
  - Practical stitches 68-79
  - Quilt stitches 100-101
- Eyelet**
- With small zig-zag 80, 94
  - With straight stitch 80, 94
- F**
- 
- Fabric**
- BERNINA Dual Transport 108
  - Center determination 130
  - Hooping 130
  - Needle and thread 14-16
  - Transport 28
- Fabric feed**
- Feed dog 28
- Feed dog**
- Fabric feed 28
  - Lowering 28, 129
  - Position 28
  - Ready to sew 28
  - Symbol 13, 28, 129
- Finishing edges 73**
- Foam pad 9**
- Foot control**
- Cable unwind/wind 18
  - Connection 13, 18
  - Plugging in 18
  - Raising and lowering the needle 18
  - Sewing speed control 18
- Front view**
- Sewing computer 12
- Function buttons 30-31, 133**
- Automatic thread cutter 30, 133
  - Nähfussposition 30, 133
  - Needle position 31
  - Needle stop 30
  - Programmable pattern end / Securing 30
  - Quick reverse 30
  - Slide speed control 30, 133
  - Start/Stop 30, 133
  - Stitch width and stitch length knob 31, 133
- Functions alphabets 38-39**
- Altering pattern length 38
  - Balance 39
  - Basic setting stitch pattern 39
  - Letter size with alphabets 39
  - Mirror image left/right/down/up 39
  - Needle position 39
  - Pattern repeat 38
  - Permanent sewing in reverse 39
  - Presser foot indicator 39
  - Presser foot pressure 39
  - Saving stitch patterns 39
  - Securing 38
  - Security program 39
  - Upper thread tension 38
- Functions buttonholes 36-37**
- Adjusting buttonhole length 36
  - Balance 37
  - Buttonhole slit width 37
  - Manual buttonhole 36
  - Presser foot indicator 37
  - Presser foot pressure 37
  - Programming buttonhole length 36
  - Securing 36
  - Security program 37
  - Stitch counter buttonhole 36
  - Upper thread tension 37
- Functions combi-mode 40-43**
- Altering pattern length 40
  - Balance 41
  - Combination repeat 43

- Combination subdivider 42
- Deleting 40
- Deleting the whole combination 43
- editing combination at cursor position 40
- Editing complete combination 41
- Kombinations-Unterbrechung 42
- Letter size with alphabets 41
- Long stitch 41
- Mirror image (left/right) of whole combination 43
- Needle position 40
- Permanent sewing in reverse 41
- Presser foot indicator 41
- Presser foot pressure 41
- Securing 42
- Security program 41
- Spiegeln links/rechts/unten/oben 40, 41
- Upper thread tension 40

### Functions Sewing 34-35

- Altering pattern length 34
- Altering stitch density 35
- Balance 35
- Basic setting stitch pattern 35
- Long stitch 35
- Mirror image left/right/down/up 35
- Needle position 35
- Needle stop down/up 34
- Pattern begin 34
- Pattern repeat 34
- Permanent sewing in reverse 35
- Presser foot indicator 35
- Presser foot pressure 35
- Saving stitch patterns 35
- Securing 34
- Security program 35
- Stitch counter 35
- Upper thread tension 35

## G

### Glossary 8

#### Guidelines

- Material/Thread/Needle size 15

## H

### Handwheel 13

### Height compensation of uneven layers 79

### Height compensation tool 9, 79, 81

### Heirloom buttonhole 80, 89

### Help 58

#### Help program

- Functions 58
- Stitch patterns 58

### Horizontal spool pin 13, 20, 22

## I

### Information 14-16, 33, 34, 44, 53, 54, 125-127, 138

#### Inserting

- Bobbin 21
- Bobbin case 21
- Needle 22
- Presser foot lifter 19
- Stitch plate 25

### Inserting the bobbin 21

## K

### Key to Signs 8

#### Knob

- Stitch length/-width 13, 31

## L

### Leaving active display 34

#### Lettering

- Altering size 111
- Choosing lower case letters 111
- Combining 110
- Correcting the combination 110
- Overview 109, 135
- Types 109, 135

### Long stitch 35

#### Long term memory

- Buttonhole 90

#### Lower thread

- Bobbin Fill 125
- Cutting 13, 21
- Darning and embroidery thread 125
- Free hand sewing 98
- Indicator 50
- Inserting the bobbin 21
- Sewing 98
- Threading 21, 129
- Winding 20
- Winding while sewing 20
- With decorative stitches 98

### Lubricating 165

## M

### Main switch 13, 18

#### Maintenance

- See cleaning

### Material, needle and thread 14-16, 125

#### Memory

- Embroidery computer 155
- Sewing computer 116-120

- Menu selection**
- Alphabets 32
  - Buttonholes 32
  - Decorative stitches 32
  - Personal Program/Memory 32
  - Practical stitches 32
  - Stitch pattern selection via numbers 32
- Metallic threads 125**
- Mirror image**
- left/right/down/up 34-36, 38-39, 40-41, 43, 138-139
- Monitoring settings**
- Lower thread indicator 50
  - Upper thread indicator 50
- Motif colors**
- Altering thread brand 153
  - Embroidering single-colored 154
  - Reallocating 153
- Moving the needle position 67**
- N**
- 
- Needle**
- Changing 22
  - Double-, triple needle 16, 23
  - Embroidery needle 123, 125, 129
  - Guidelines 15
  - Holder 13
  - Important sewing information 14-16
  - Inserting/removing 22
  - Needle-thread-combination 15
  - Overview 16
  - Position 13, 31, 35, 39, 40
  - Raise/lower 18, 30, 34
  - Stop down/up 30, 34
  - Threading 24
- Needle threader 13, 24**
- Needle, thread and material 14**
- Needle-thread-combination 15**
- O**
- 
- Opening for darning hoop connection 13**
- Optional accessory**
- Connection 13
- Overlock**
- Double overlock 74
  - Stitches 62-63
- Overview**
- Alphabets 109, 135, 174-176
  - Buttonholes 80, 171
  - Creative consultant 57
  - Decorative stitches 95, 171-173
  - Display 32-43, 134-140
  - Edit 138-139
  - Embroidery motifs 136, 177-184
  - Embroidery menu 142-143
  - Embroidery mode 134
  - Function buttons 30-31, 133
  - Functions alphabets 38-39
  - Functions buttonholes 36-37
  - Functions combi-mode 40-43
  - Functions embroidery 138-140
  - Functions Sewing 34-35
  - Main display 34-35
  - Needle 16
  - Practical stitches 62-63, 171
  - Quilt stitches 99, 173
  - Setup Display 44
  - Sewing computer 12-13
  - Tutorial 55
- P**
- 
- Pattern begin 34**
- Pattern repeat 34**
- PC-connection 18**
- Personal memory**
- Permanent 66
  - Reset to basic setting 65
  - Temporary 65
- Personal program 112-115**
- Altering/overwriting stitch patterns 114
  - Creating personal display 112
  - Deleting stitch patterns 115
  - Preparing stitch patterns 112
  - Preparing/programming stitch patterns 112
  - Stitch pattern selection in personal program 113
- Polyester thread 14, 125**
- Power cable**
- Connection 13, 18
- Practical stitches 62-79**
- Bartack program 63
  - Basting stitch 63, 77
  - Blind stitch 62, 76
  - Blind stitch narrow 63
  - Darning manual/automatic/reinforced 71-73
  - Darning program 72, 73
  - Double overlock 62, 74
  - Gathering stitch 62
  - Honeycomb stitch 62
  - Jersey stitch 62
  - Knit overlock 63
  - Large Fly stitch 63
  - Lycra stitch 63
  - Reinforced darning program 63
  - Reinforced overlock 63
  - Running stitch 62
  - Securing program 62, 77
  - Selecting 62
  - Sewn out zig-zag 63
  - Simple darning program 63
  - Single straight stitch 63



- Straight stitch 62, 68
- Stretch overlock 62
- Stretch stitch 63
- Super stretch 62
- Three single straight stitches 63
- Triple straight stitch 62, 68
- Triple straight stitch with longstitch 63
- Triple zig-zag 62, 69
- Universal stitch 63
- Vari overlock 62
- Zig-zag 62
- Zipper 70

**Preparation**

- Embroidery 128-132
- Embroidery computer 129
- Embroidery module 128
- Sewing computer 18-28

**Presser foot**

- As guide 75
- Attaching/Removing 24
- Changing 24
- Display 35, 37, 39, 41
- Overview 10
- Pressure 27, 35, 37, 39, 41
- Raise/lower 13, 18, 19, 30
- Standard Accessory 10

**Presser foot lifter 9, 19****Presser foot pressure**

- Display 27
- Increase/loosen 27
- Saving 27

**Q****Quick Reverse button 30****Quilt stitches**

- Blanket stitch 99
- Blanket stitch (dual) 99
- Blind stitch (narrow) 99
- Decorative quilt stitch variations 99
- Double Blanket stitch (dual) 99
- Double blanket stitch 99
- Feather stitch 99
- Feather stitch variations 99
- Handlook quilt stitch 99
- Overview 99
- Patchwork stitch/Straight stitch 99
- Quilt stitch/Straight stitch 99
- Quilters' securing program 99
- Quiltstich/Hand look stitch variations 99
- Satin stitch 99
- Stippling stitch 99

**Quilting**

- Free-motion quilting 101
- Handlook quilt stitch 100
- Stipple quilting 101
- With BSR 102-106

**R****Rayon threads 14****Rayon threads 14, 125****Rear thread guide 13, 20****Removing**

- Bobbin case 21
- Embroidery hoop 160
- Embroidery module 128
- Needle 22
- Presser foot 24
- Slide-on table 18
- Stitch plate 25

**Reset**

- Deleting user data 52
- Reset to basic setting 52

**Reset to basic setting 52****S****Safety Instructions 2-3****Satin stitch 127****Saving**

- Presser foot pressure 27
- Stitch pattern combination 116
- Stitch patterns 112-113
- Stitch patterns 145, 155-156

**Scrolling down/up 33****Seam**

- Blind 76
- Edges 75
- Visible 76

**Seam guide**

- As guide 75

**Seam ripper 9, 83****Securing 30****Securing program 46, 62, 77****Selecting**

- Display color 46
- Language 53
- Stitch patterns 126
- Stitch patterns 33, 64

**Selecting language 53****Selection**

- Scrolling down/up 33
- Single and combi mode 33

**Service data 54**

<b>Setting</b>			
• Confirming		34	
• Deleting		34	
<b>Setup Program</b>	<b>44-54</b>		
• Audio System		49	
• Basic setting		44, 52	
• Beeper for BSR		49	
• Brightness		45	
• Brightness sewing light		45	
• Calibrating automatic buttonhole foot No. 3A/ Cleaning/Packing position		51-52	
• Calibrating display		49	
• Display color		46	
• Display settings		45	
• Embroidery settings		48	
• Information		53-54	
• Monitoring settings		50	
• Overview Display		44	
• Reset		52	
• Sewing light		45	
• Sewing settings		46-47	
• Update		50-51	
• Updating sewing/embroidery computer		50-51	
• Welcome text		45	
• Winder speed		50	
<b>Sewing</b>			
• Accessory		9-11	
• Alphabets		109	
• Blind hem		76	
• Buttonhole		80-94	
• Combinations		116	
• Corners		79	
• Edges		75	
• Eyelets		94	
• Flat joining seam		78	
• Function buttons		30-31	
• Hem visible		76	
• Quick reverse		30	
• Sewing on a button		93	
• Sewing techniques		57	
• Zipper		70	
<b>Sewing corners</b>	<b>79</b>		
<b>Sewing in reverse</b>			
• Permanent		35	
<b>Sewing in the zipper</b>	<b>70</b>		
<b>Sewing light</b>	<b>45</b>		
<b>Sewing on buttons</b>	<b>93</b>		
<b>Sewing settings</b>			
• Altering upper thread tension		46	
• Automatic securing program		46	
• Automatic thread cutter		46	
• Automatic thread cutter and securing stitches		47	
• Presser foot in hover position		47	
• Presser foot position when needle stop position down		47	
• Sewing speed control		46	
<b>Sewing speed</b>	<b>18, 30, 48</b>		
<b>Sewing-/Embroidery Computer</b>			
• Function buttons		30-31, 133	
<b>Single and combi mode</b>	<b>33</b>		
<b>Slide-on table</b>			
• Attaching/removing		18, 128	
<b>Software version</b>	<b>53</b>		
<b>Speed</b>			
• Foot control		18	
• Regulating		13, 18, 30, 46, 133	
<b>Spool disc</b>	<b>9, 20, 22</b>		
<b>Spool pin</b>			
• Horizontal		13, 20, 22, 129	
• Vertical		13, 19, 23	
<b>Stabilizer</b>			
• Embroidery stabilizer		131	
• Iron-on interfacing		132	
• Spray adhesive		131	
• Water soluble stabilizer		132	
<b>Stabilizer and interfacing</b>	<b>82</b>		
<b>Standard Accessory</b>	<b>9-11, 123</b>		
<b>Start-/Stop-Button</b>	<b>30, 133</b>		
<b>Starting to embroider</b>	<b>160</b>		
<b>Step stitch</b>	<b>127</b>		
<b>Stipple quilting</b>	<b>101</b>		
<b>Stitch pattern selection</b>			
• Direct		64	
• Stitch number		64	
<b>Stitch patterns</b>			
• Adjusting individually		65	
• Deleting		40, 43, 117, 120	
• Display		33	
• Personal memory		65-66	
• Selecting		33, 64	
<b>Stitch plate</b>			
• As guide		75	
• Inserting/removing		25	
• Marking		25	
<b>Stitch selection</b>			
• Cancelling		64	
• Direct		64	
• Via stitch number		64	
<b>Stitch types</b>			
• Connecting stitches		127	
• Satin stitch		127	
• Step stitch		127	
• Underlay stitches		127	

<b>Straight stitch</b>	<b>62, 68</b>	<b>Topstitching outer edges</b>	<b>75</b>
<b>Straight-/CutWork stitch plate</b>	<b>129</b>	<b>Triple straight stitch</b>	<b>62, 68</b>
<b>System settings</b>		<b>Triple zig-zag</b>	<b>62, 69</b>
• Creative consultant	32, 57	<b>Troubleshooting</b>	<b>166-170</b>
• Deleting settings	32	<b>Tutorial</b>	<b>32, 55-56</b>
• eco	32, 60	• BSR	55
• Help	32, 58	• Buttonholes	55
• Home	32	• Embroidery	55
• Setup Program	32, 44	• Miscellaneous	55
• Tutorial	32, 55-56	• Needle	55
<b>T</b>		• Presser foot	55
<hr/>		• Presser foot lifter (FHS)	55
<b>Tension</b>	<b>26</b>	• Quilting	55
<b>Thread</b>		• Sewing techniques	55
• Breakage	163, 166	• Thread/Threading	55
• Breaks	100, 101, 163, 166	• Troubleshooting	55
• Embroidery threads	15, 100, 125, 129	<b>Types of fabric</b>	<b>57</b>
• Important sewing information	125-127	<b>U</b>	
• Important sewing information	14-16	<hr/>	
• Needle / thread combination	15, 166	<b>Underlay stitches</b>	<b>127</b>
<b>Thread cutter</b>		<b>Update</b>	<b>50-51</b>
• Automatic	13, 30, 46, 47, 48, 133	<b>Upper thread</b>	
• Lower thread	13, 21	• Indicator	50
• On bobbin winder	13, 20	• Tension	26, 35, 37, 38, 40, 46, 143
• On the head frame	13, 24	• Threading	22, 129
<b>Thread cutter in hook opening</b>	<b>12-13, 21</b>	<b>V</b>	
<b>Thread guide</b>		<hr/>	
• At the back	13, 22	<b>Vertical spool pin</b>	<b>13, 19</b>
• Bobbin case	21	<b>W</b>	
• Eyelet	13, 20	<hr/>	
<b>Thread take-up cover</b>	<b>13, 22</b>	<b>Welcoming text</b>	
<b>Thread tension</b>		• Entry/correction	45
• Back to basic setting	26	<b>Z</b>	
• Embroidery motif	143	<hr/>	
• Upper thread	22, 26, 34, 35	<b>Zoom</b>	
<b>Thread, needle and material</b>	<b>14</b>	• Minus	138, 152
<b>Threader</b>	<b>13, 24</b>	• Plus	138, 152
<b>Threading</b>			
• Double-/Triple needle	23		
• Lower thread	21, 129		
• Needle	13, 24		
• Upper thread	22, 129		
<b>Threading the double needle</b>	<b>23</b>		
<b>Threading the triple needle</b>	<b>23</b>		
<b>Top stitching edges</b>	<b>75</b>		
<b>Topstitching</b>			
• Edges	75		
• Narrow/wide	75		



**Text**

Herbert Stolz/Susanne Ribl

**Graphics**

[www.sculpt.ch](http://www.sculpt.ch)

**Pictures**

Patrice Heilmann, CH-Winterthur

**Typesetting, Layout**

Susanne Ribl

**Copyright**

2012 BERNINA International AG, CH-Steckborn

In partnership with

AMANN  
GROUP

Mettler®

