

10 x 10 cm

4 x 4 Inch

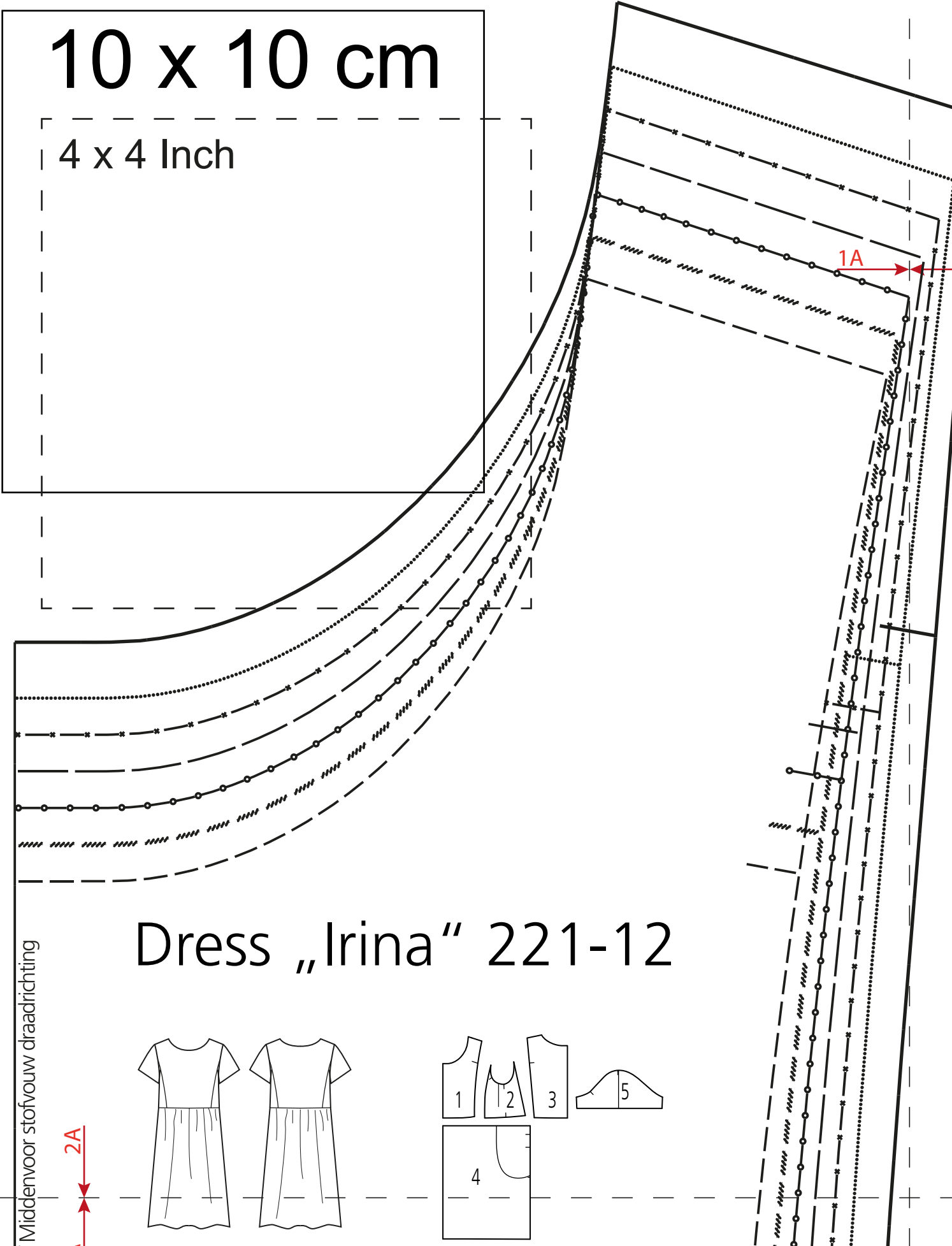

Dress „Irina“ 221-12

Middenvoor draadrichting

2A

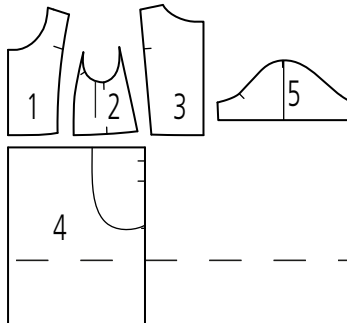
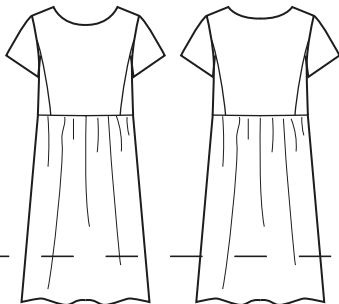

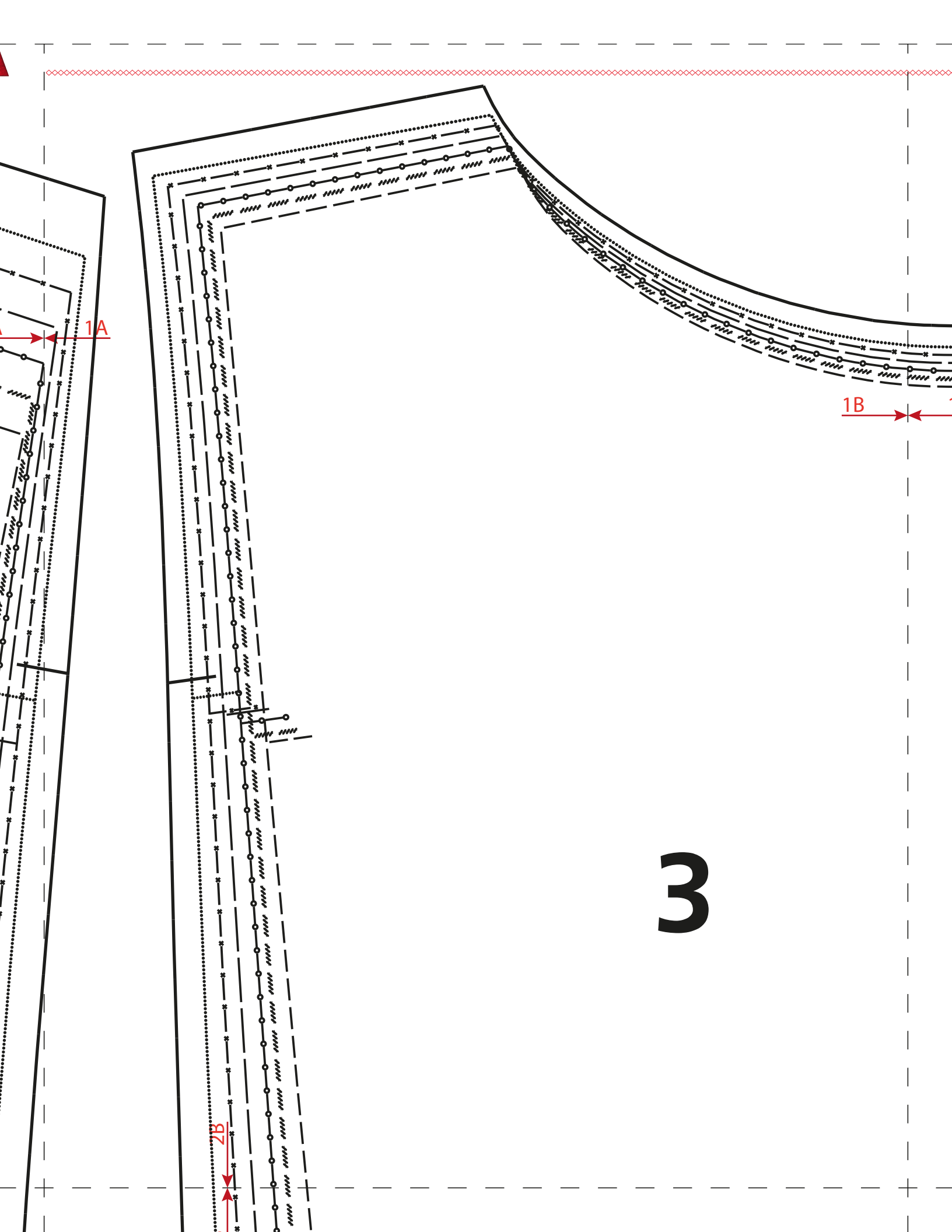

1A

1B

ZB

3

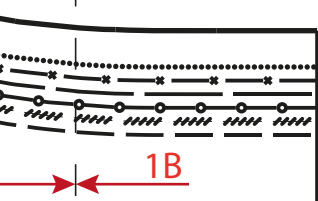

Centre back fold straight grain/ Milieu envers pli droit fil/ Middenachter stofvouw Draadrichting

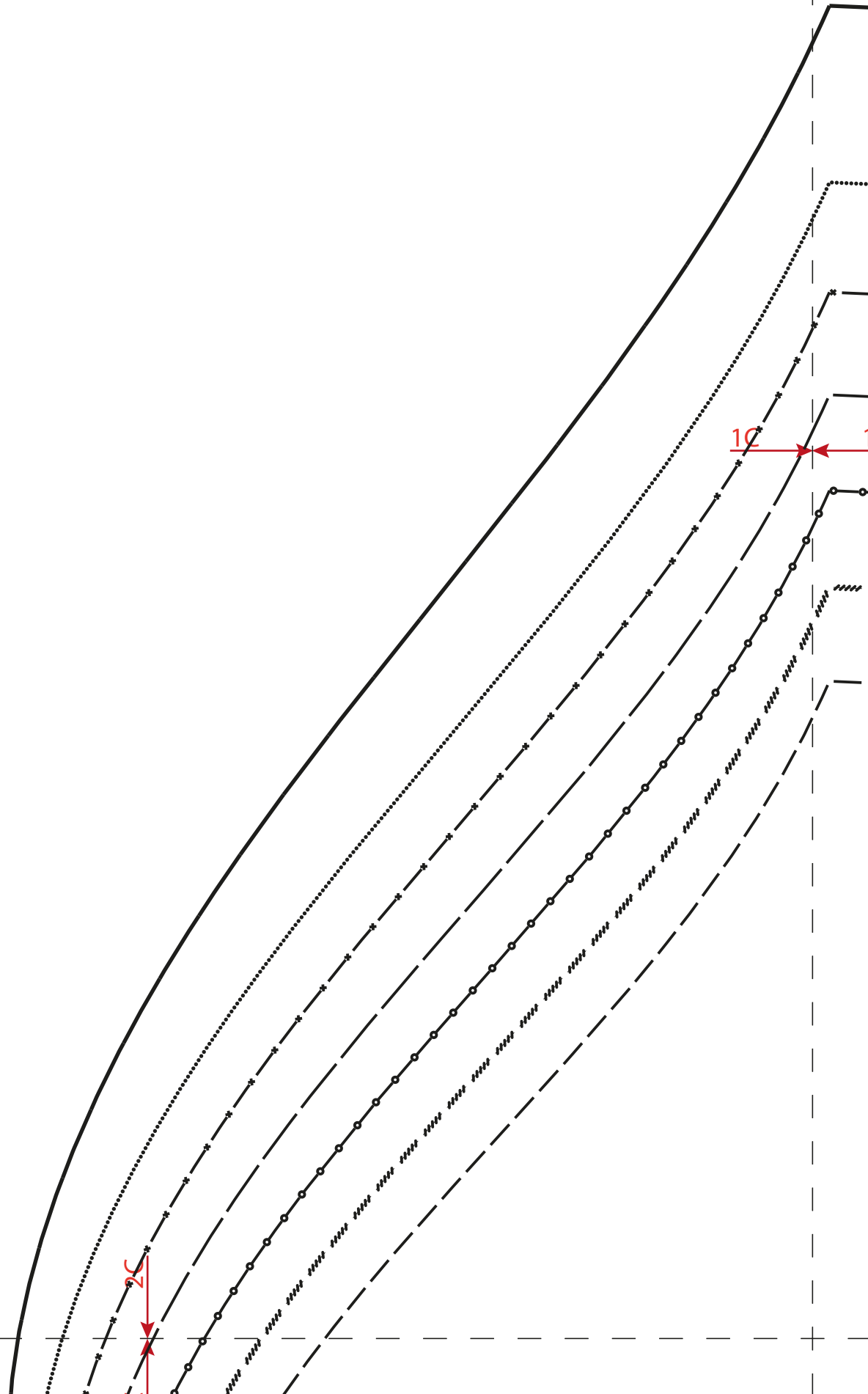

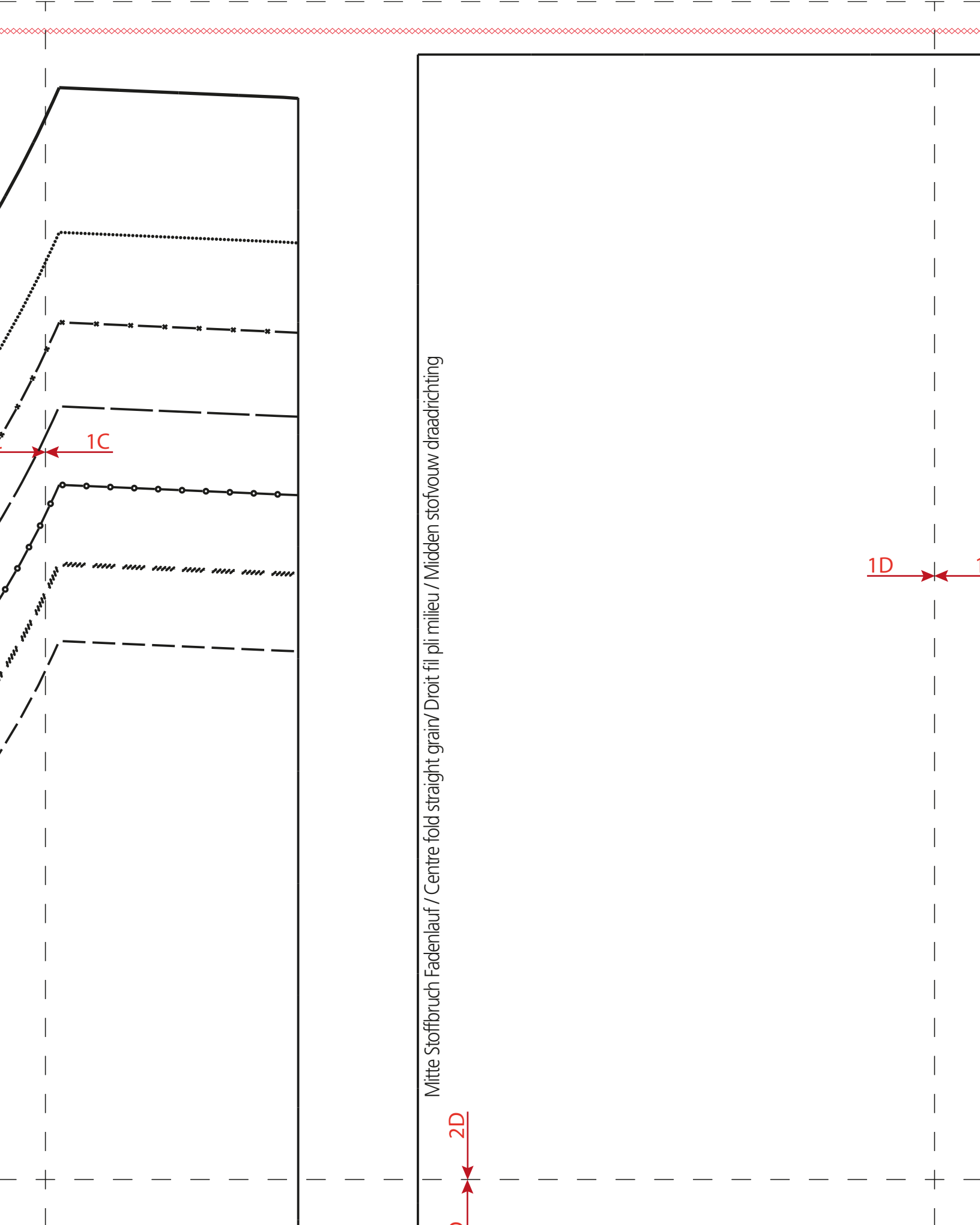

Mitte Stoffbruch Fadenlauf / Centre fold straight grain / Droit fil pli milieu / Midden stofvouw draadrichting

1D

2D

1C

1D

4

1E

2E

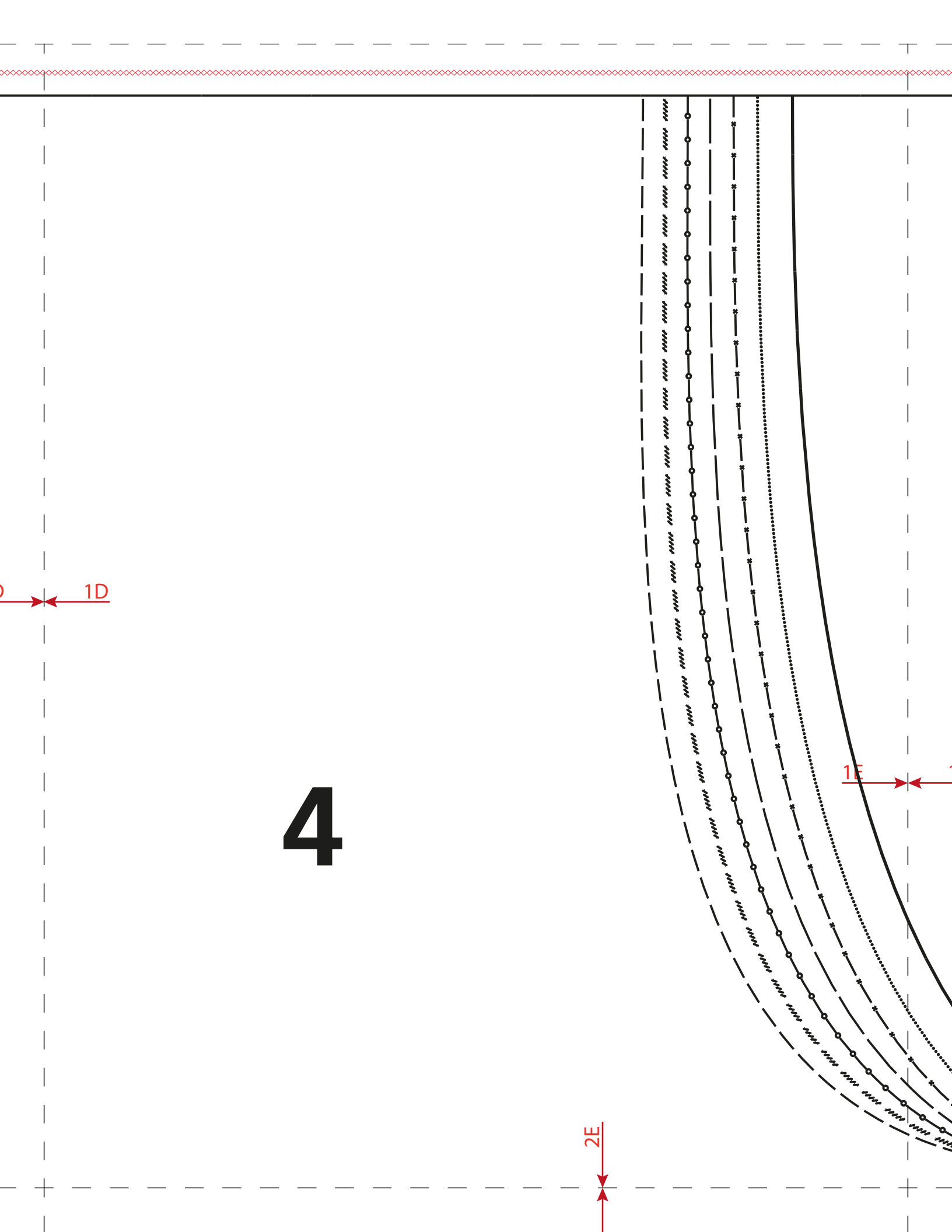

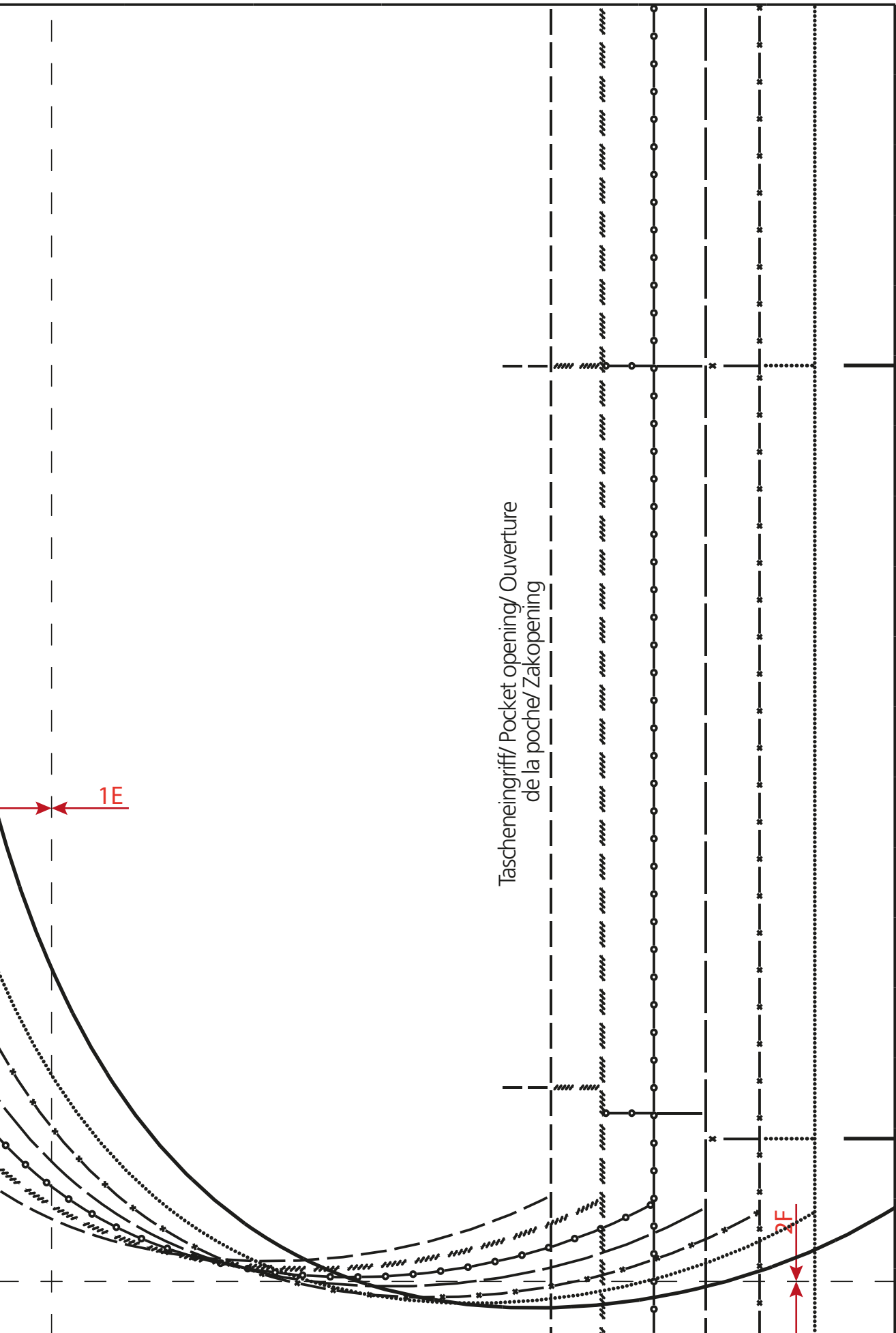

Vordere Mitte Stoffbruch Fadenlauf/ Centre front fold straight grain/ Milieu endroit pli droit fil/ Middenvooc

2A

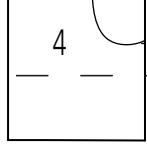
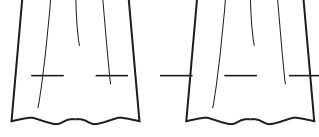

1

2A

3A

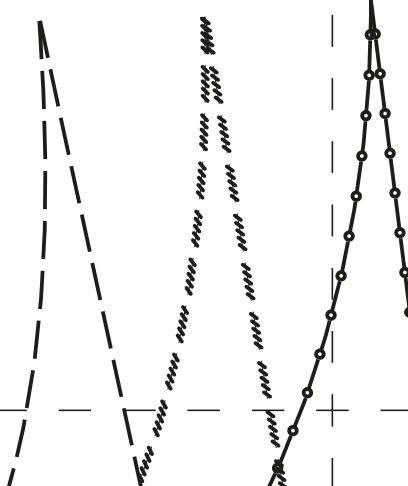
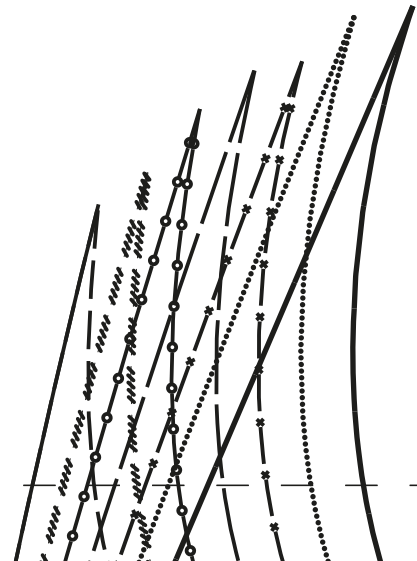

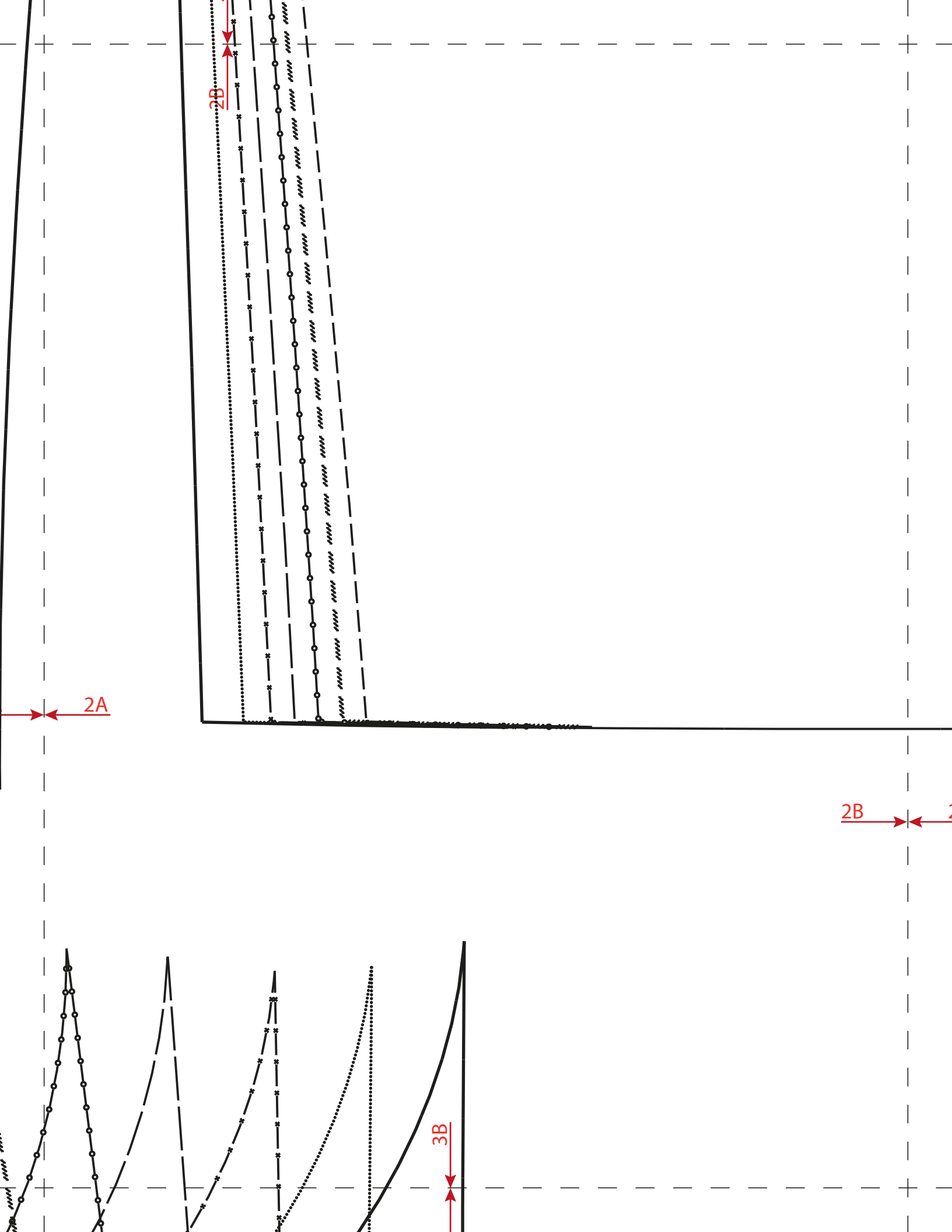

Rückwärtige Mitte Stoffbruch Fadenlauf / Centre back

Fadenlauf / Straight grain / Droit fil / Draadrichting

5

2B

2C

3C

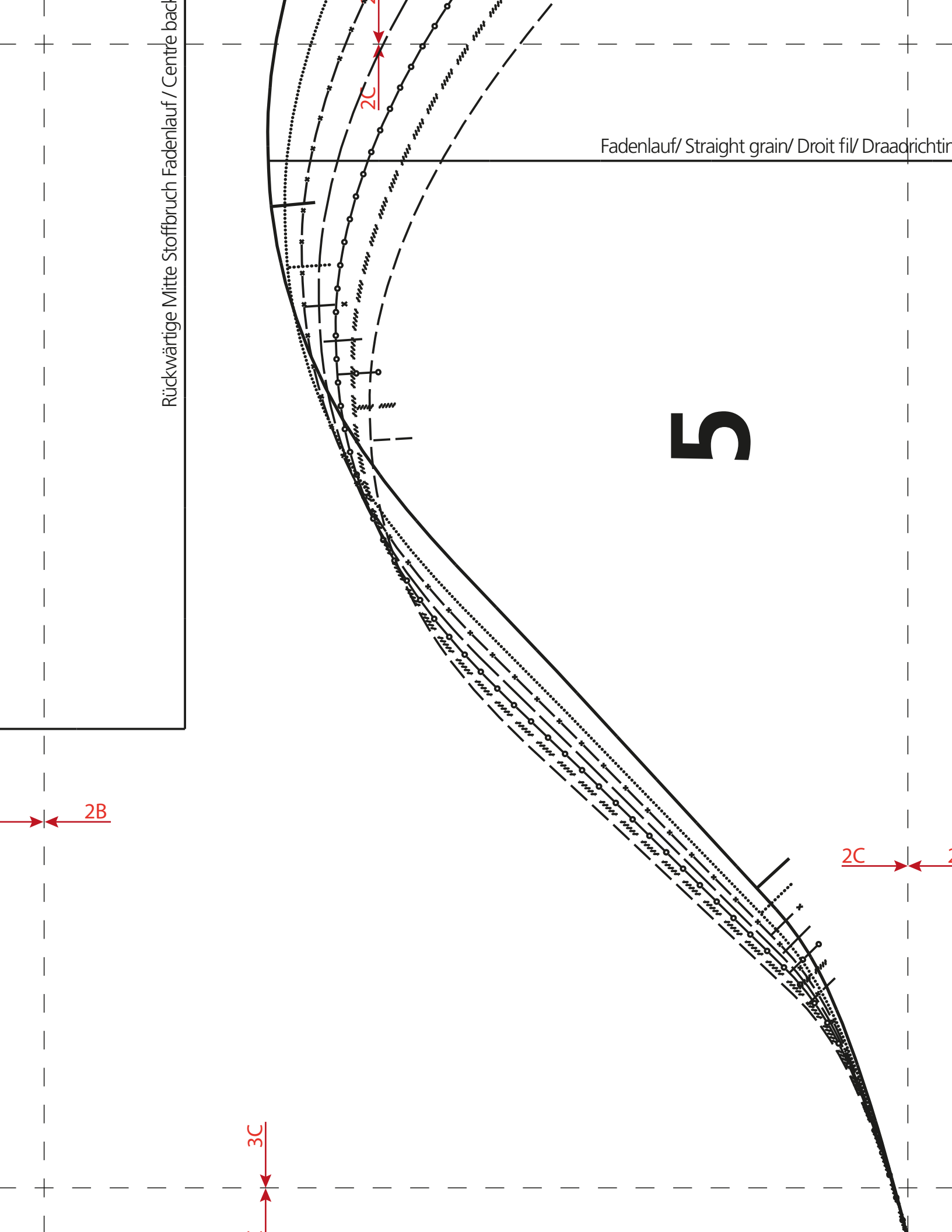

Draadrichting

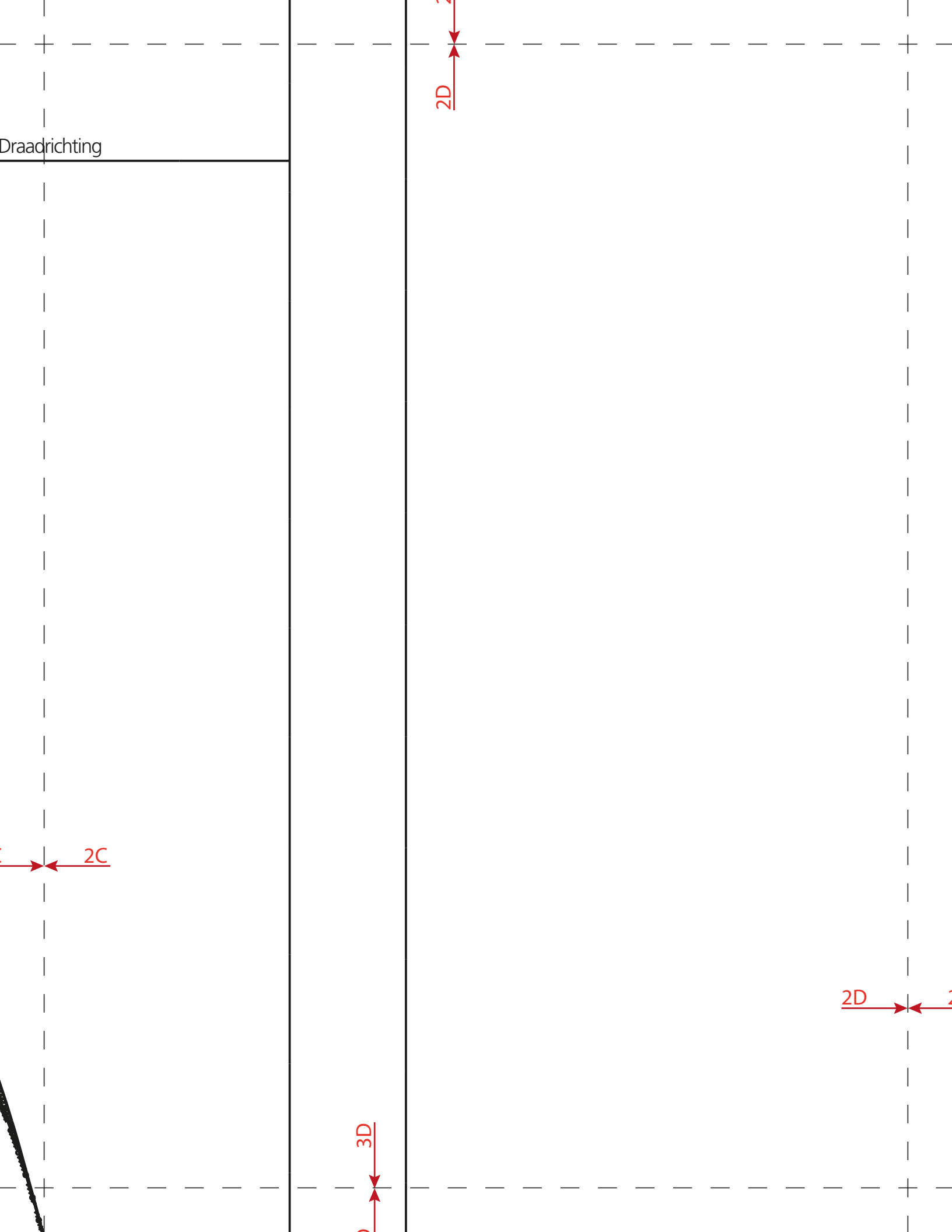

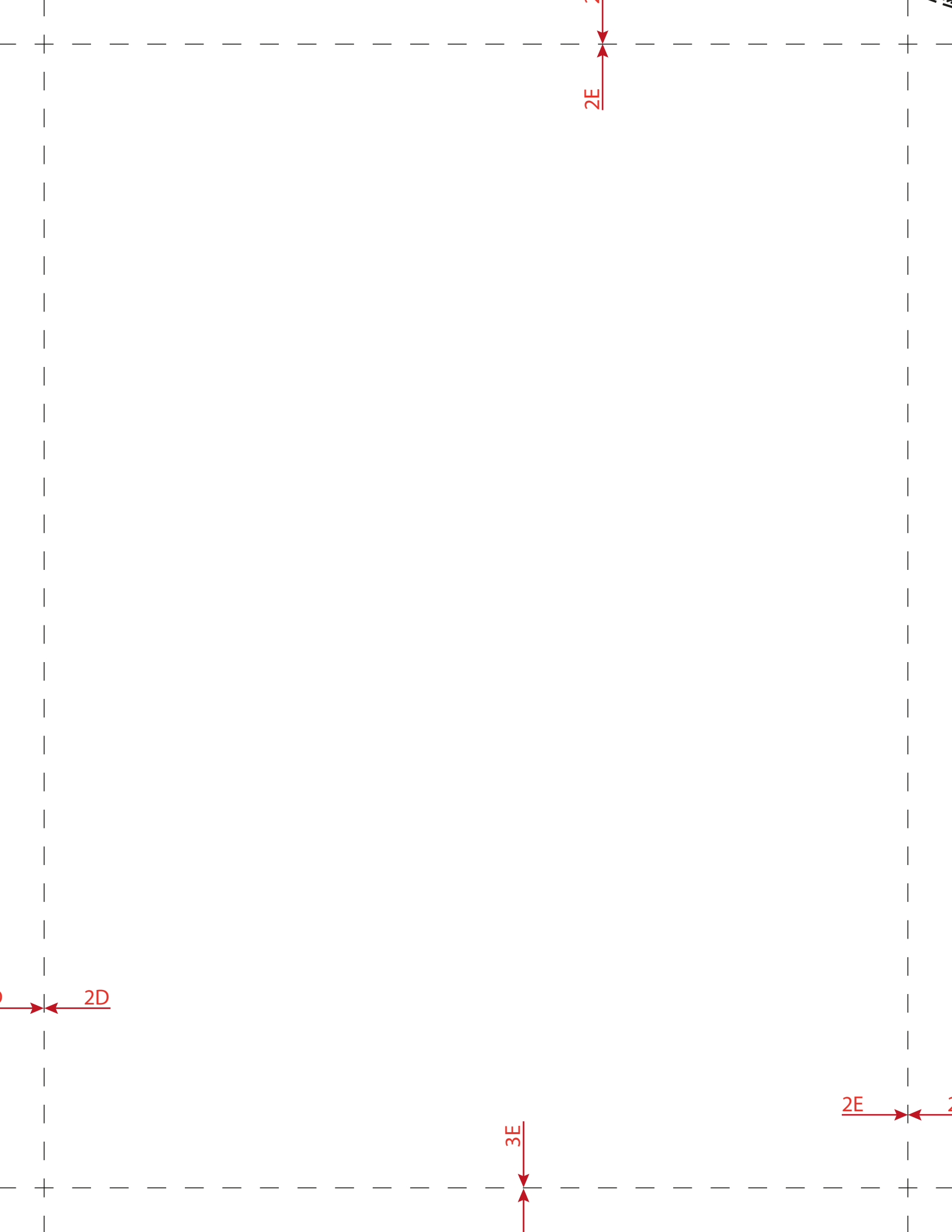

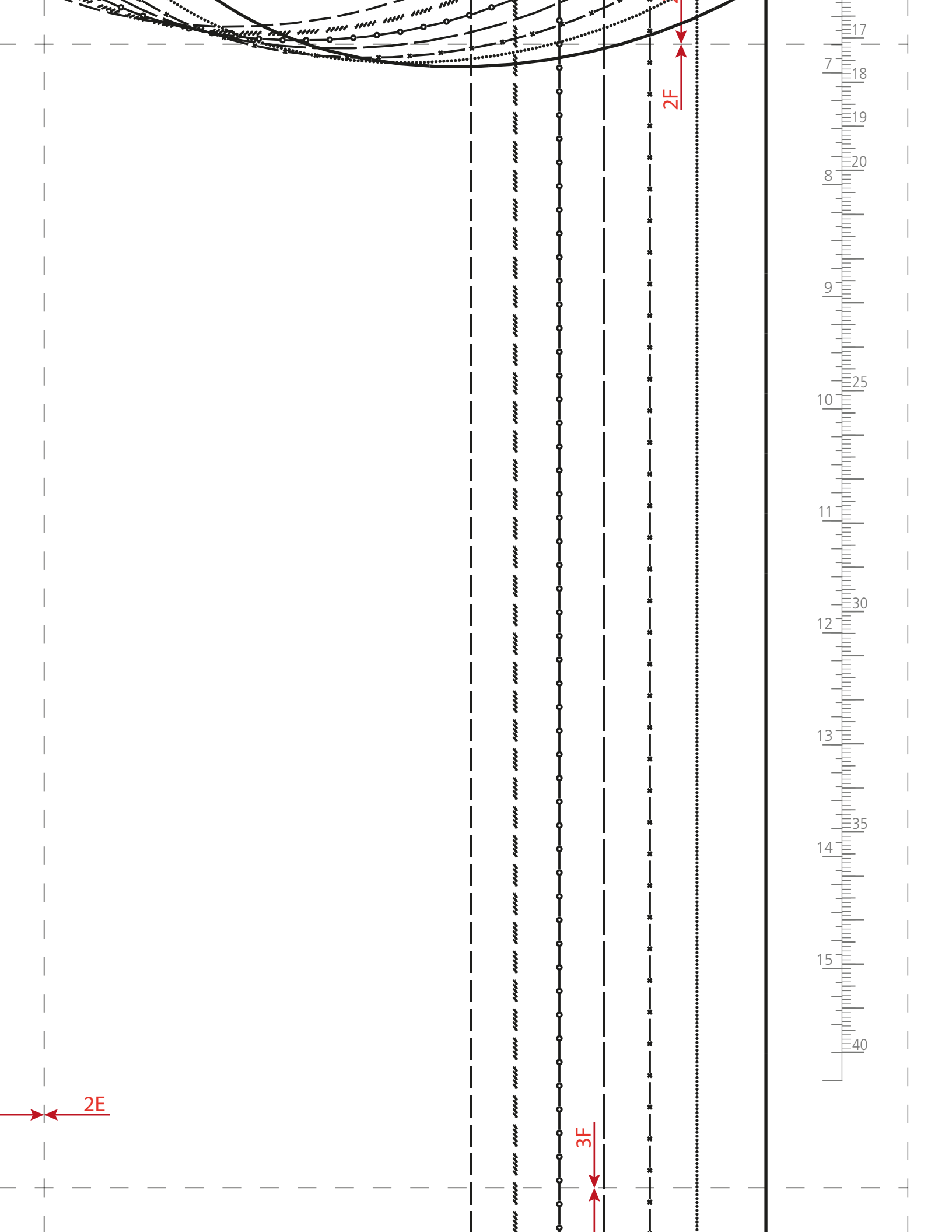

Fadenlauf/ Straight grain/ Droit fil/ Draadrichting

2

3A

3A

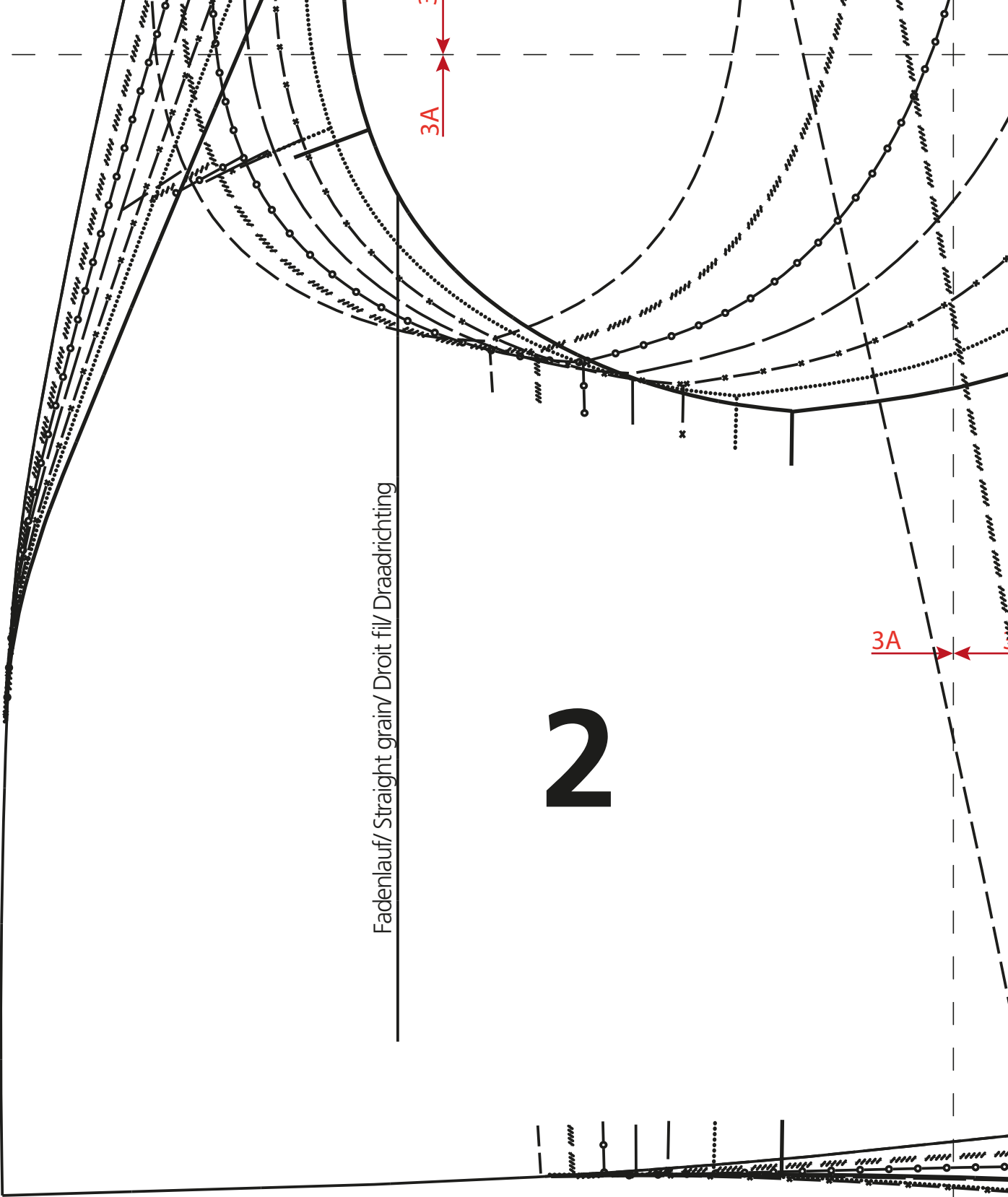

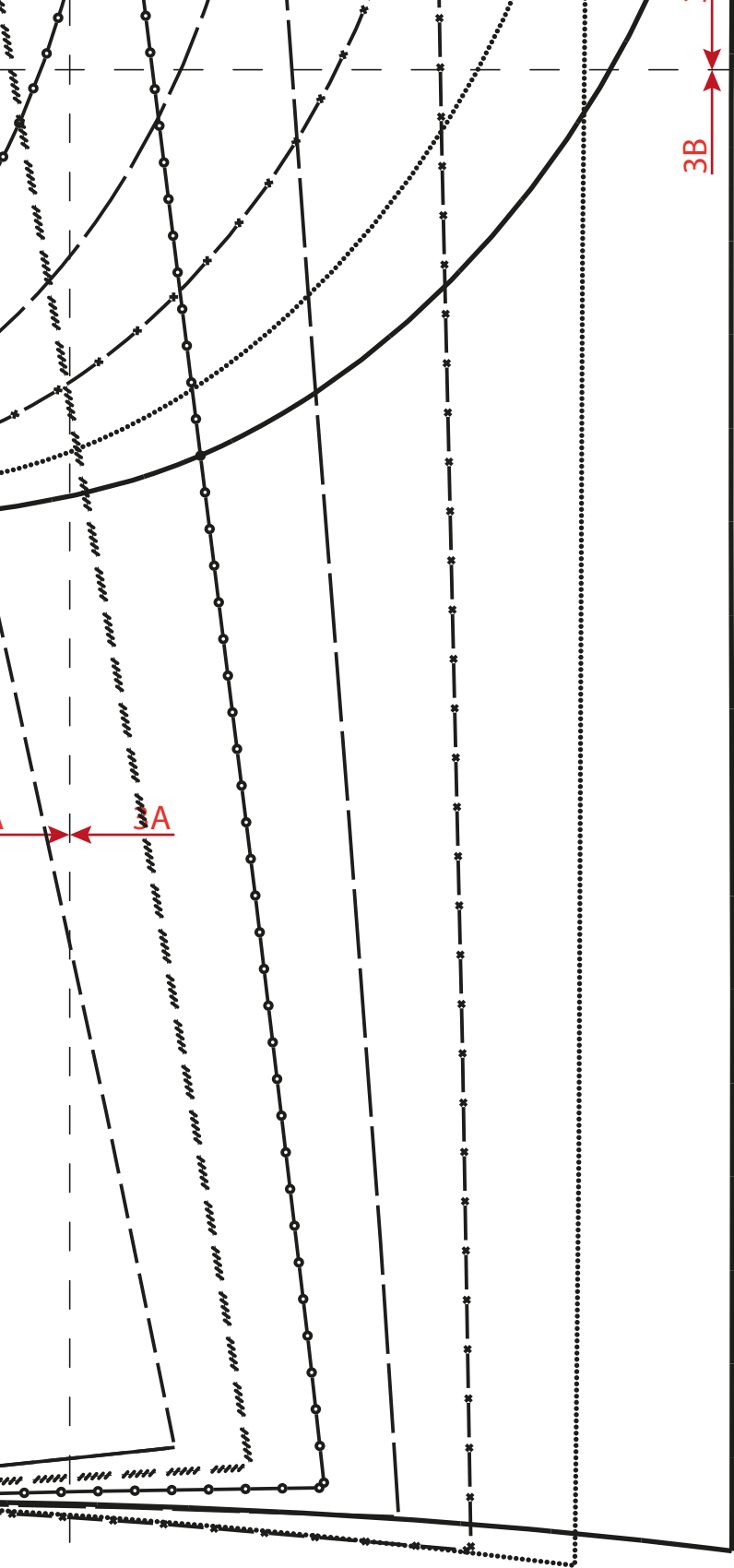

$3B$

$3B$

$3B$

3C

Für Körpergröße/ for height/ pour la taille/ Maten voor lichaamsgrootte 168 cm								
Grösse/ Size/ Taille/ Maat	34	36	38	40	42	44	46	48
Oberweite/Bust/ Poitrine/ Bovenwijdte	80	84	88	92	96	100	104	110
Tailenweite/ Waist/ Taille/ Tailenwijdte	64	67	71	75	79	83	87	93
Hüftweite/ Hip/ Hanche/ Heupwijdte	90	93	96	99	102	105	108	114
Vord. Tailenlg./ Front waist length/ Longueur taille devant/ Tailleleugte voor	42	43	44	45	46	47	48	49
Rückw. Tailenlg./ Back waist lenth/ Longueur taille dos/ Ruglengte tot taille	41	41	41	42	42	42	42	43

Legende/ Legend/ Légend

Grösse/
Size/
Taille/
Maat

-----	34
—————	36
//// //	38
—○—○—○—	40
—————	42
—*—*—*	44
.....	46
—————	48

For height 66 inch:	Taille	34	36	38	40	42	44	46	48
Bust		31,5	33,0	34,6	36,2	37,8	39,4	40,9	43,3
Waist		25,2	26,4	28,0	29,5	31,1	32,7	34,3	37,0
Hip		35,4	36,6	37,8	39,0	40,2	41,3	42,5	44,9
Front waist length		16,5	17,0	17,3	17,7	18,0	18,5	18,9	19,2
Back waist lenth/		16,0	16,0	16,0	16,5	16,5	16,5	16,5	16,9

3B

3C

Wichtig: Alle Schnittteile sind ohne Nahtzugabe, falls nichts anderes vermerkt ist!

Important: All Patterns are without seam allowances, unless otherwise indicated !

Important: Toutes découpes sont sans surplus de couture (sauf mention contraire)!

Attentie: Alle patroondeelen zijn zonder naadtoeslag, tenzij anders vermeld

Keine Inspiration mehr versäumen – mit einem Abo!
No more missing inspiration – with a subscription!



Ja, ich möchte die Inspiration ab der nächsten Ausgabe für 1 Jahr abonnieren (3 Hefte pro Jahr).

Yes, I would like to subscribe to Inspiration from the next issue for 1 year (3 issues per year).

Jeweils im Januar erscheint das Frühjahrsheft, im Mai das Sommerheft und im September die Herbst/Winteraushgabe. In allen Ausgaben sind Schnittmuster enthalten.

The spring issue is published in January, the summer issue in May and the autumn/winter issue in September. All issues contain pattern plans.

Land/ Country	Print	Digital	Sprache/ Language
<input type="checkbox"/> Schweiz/ Switzerland	CHF 24	CHF 14	<input type="checkbox"/> Deutsch/ German
<input type="checkbox"/> Europa/ Europe	EUR 21	EUR 11	<input type="checkbox"/> Englisch/ English
<input type="checkbox"/> Übersee/ Overseas	USD 38/AUD 54	USD 14,50/AUD 24,50	<input type="checkbox"/> Französisch/ French
alle Preise inkl. MwSt. und Porto/ All prices inclusive of VAT and postage			<input type="checkbox"/> Niederländisch/ Dutch

Name

Geburtsjahr (optional)/ Year of birth (optional)

Strasse, Nr./ Street, no.

PLZ, Ort/ Postal code, town

Telefon - E-Mail/ Telephone no. - Mail

Mein Abonnement beginnt mit der jeweils nächsten Ausgabe. Es läuft nach Erhalt von 3 Heften automatisch weiter, sofern ich nicht rechtzeitig vor Ablauf kündige.
Subscriptions normally begin with the next issue. Subscriptions are automatically renewed after 3 issues if not cancelled in time before their expiry.

- Ich bin damit einverstanden, dass BERNINA meine Daten zur Weiterverarbeitung an Dritte (insb. die medienwerkstatt ag, Schweiz) übermittelt, sofern dies erforderlich ist, um die vertragliche Leistung in Anspruch nehmen zu können.
 I agree that BERNINA may transfer my data to third parties (esp. the media workshop AG, Switzerland and Datatrans AG, Switzerland), if this is required in order to make use of the contractual service.
- Ich bin damit einverstanden, dass meine Daten für Zwecke der Direktwerbung von BERNINA verarbeitet und mit anderen Informationen, die von BERNINA für denselben Zweck erhoben wurden, verknüpft werden. Weitere Informationen kann ich in der Datenschutzerklärung (bernina.com) einsehen. Diese Einwilligung kann ich jederzeit kostenfrei widerrufen.
 I agree that my data will be processed for direct marketing purposes by BERNINA and will be linked with other information which have been collected by BERNINA for the same purpose. I can find further information in the privacy policy (bernina.com). I can revoke this consent free of charge at any time.

**BERNINA International AG, Redaktion Inspiration, CH-8266 Steckborn, www.inspiration.bernina.com
 E-Mail: inspiration@bernina.com**

