

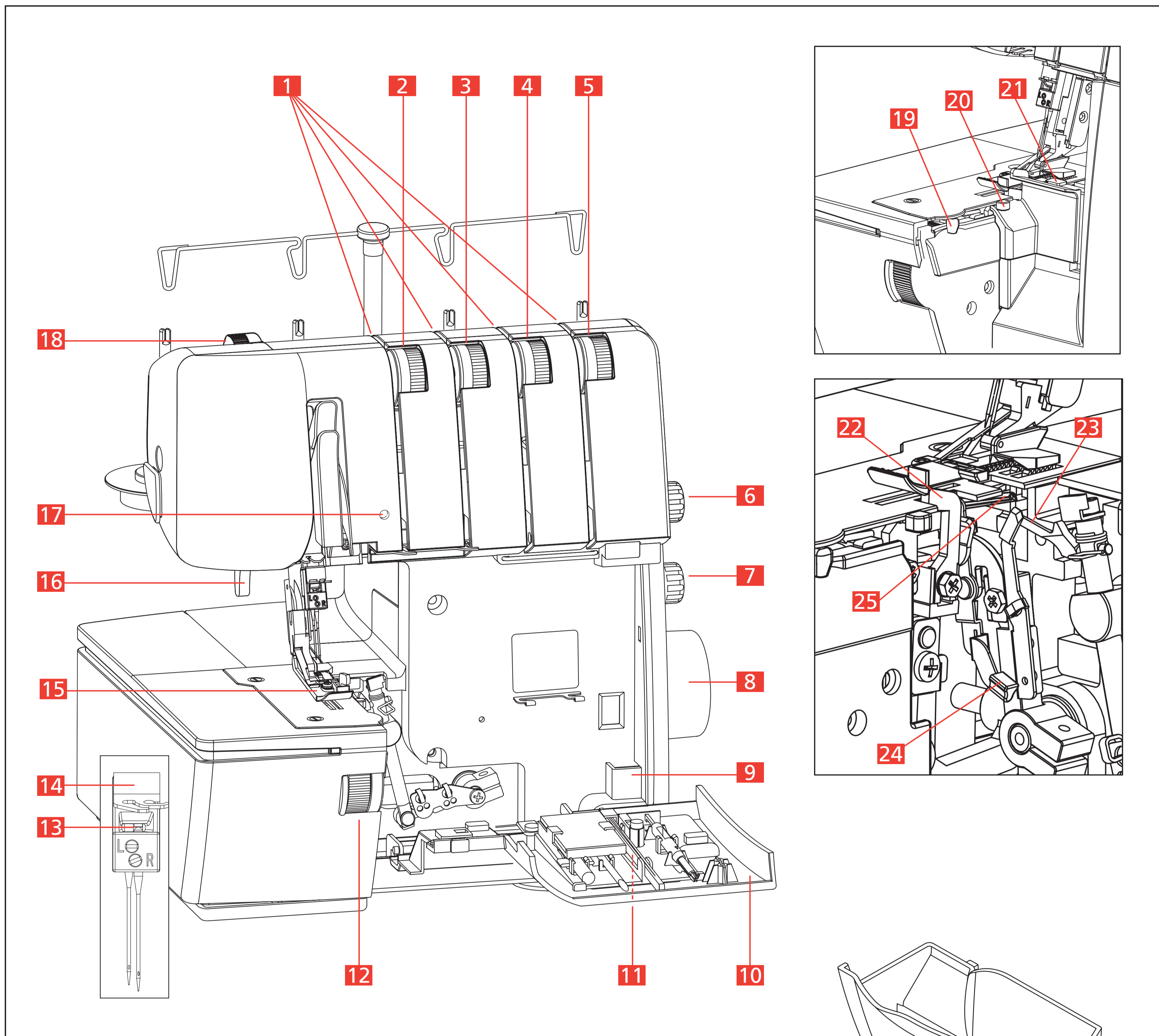

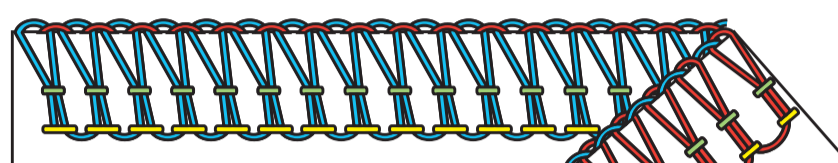







BERNINA L 460 / L 450

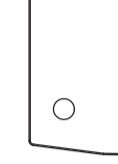

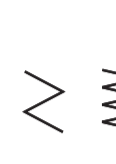
- | | |
|---|--|
| 1 Fadenvorspannung | 15 Nähfuss |
| 2 Fadenspannungs-Einstellung (gelb) LN | 16 Nähfussheber |
| 3 Fadenspannungs-Einstellung (grün) RN | 17 Sicherheitsanzeige (nur bei L 460) |
| 4 Fadenspannungs-Einstellung (blau) UL | 18 Nähfussdruck |
| 5 Fadenspannungs-Einstellung (rot) LL | 19 mtc-Fadenkontrolle |
| 6 Stichlänge (SL) | 20 Rollsaum-Wahlhebel |
| 7 Differenzialtransport (DF) | 21 Messerpositionsanzeige |
| 8 Handrad | 22 Messer |
| 9 Nadelkissen | 23 Obergreifer (UL) |
| 10 Greiferdeckel | 24 Untergreifereinfädler-Hebel |
| 11 Kniehebel-Anschluss | 25 Untergreifer (LL) |
| 12 Schnittbreite (CW) | 26 Stoffauffangbehälter |
| 13 Nadelfenster | 27 Anschietisch |
| 14 Nadelhalter | 28 Kniehebel (FHS) (nur bei L 460) |

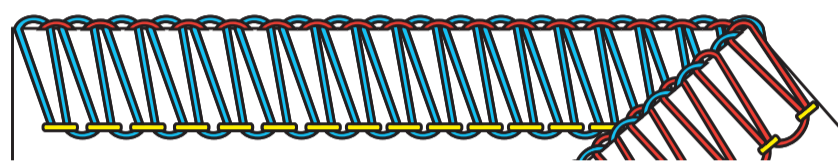
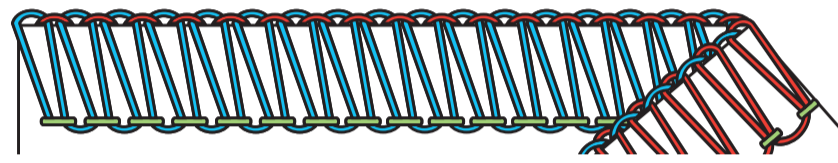
BERNINA L 460 / L 450: Stiche und Einfädeln

	LN	RN	UL	LL	Rollsaum Wahlhebel	ULC Obergreifer- abdeckung	CW	SL	DF
 4-Faden Overlock	 4	 4	 4	 4	 ▲	 -	 6	 2.5	 1
 3-Faden Overlock (linke Nadel)	4	-	4	4	▲	-	6	2.5	1
 3-Faden Overlock (rechte Nadel)	-	3.5	4	4	▲	-	6	2.5	1
 3-Faden Rollsaum	-	3.5	4	7.5	▼	-	5	1	1

Legende

- LN: Linke Nadel
 RN: Rechte Nadel
 UL: Obergreifer (Upper Looper)
 LL: Untergreifer (Lower Looper)
 ULC: Obergreiferabdeckung (Upper Looper Converter)
 CW: Schnittbreite (Cutting Width)
 SL: Stichtlänge (Stitch Length)
 DF: Differenzialtransport (Differential Feed)

Einfädeln

1. Maschine ausschalten
2. Handrad drehen, um Nadeln hochzustellen
3. Nähfuß anheben, um Fadenspannung zu öffnen
4. Die Maschine in der folgenden Reihenfolge einfädeln: Obergreifer (1) / Untergreifer (2) / rechte Nadel (3) / linke Nadel (4)
5. Grundeinstellungen: siehe Tabelle
6. Nähprobe erstellen

Untergreifereinfädler-Hebel

