

10 x 10 cm

4 x 4 Inch

1

1A

2A

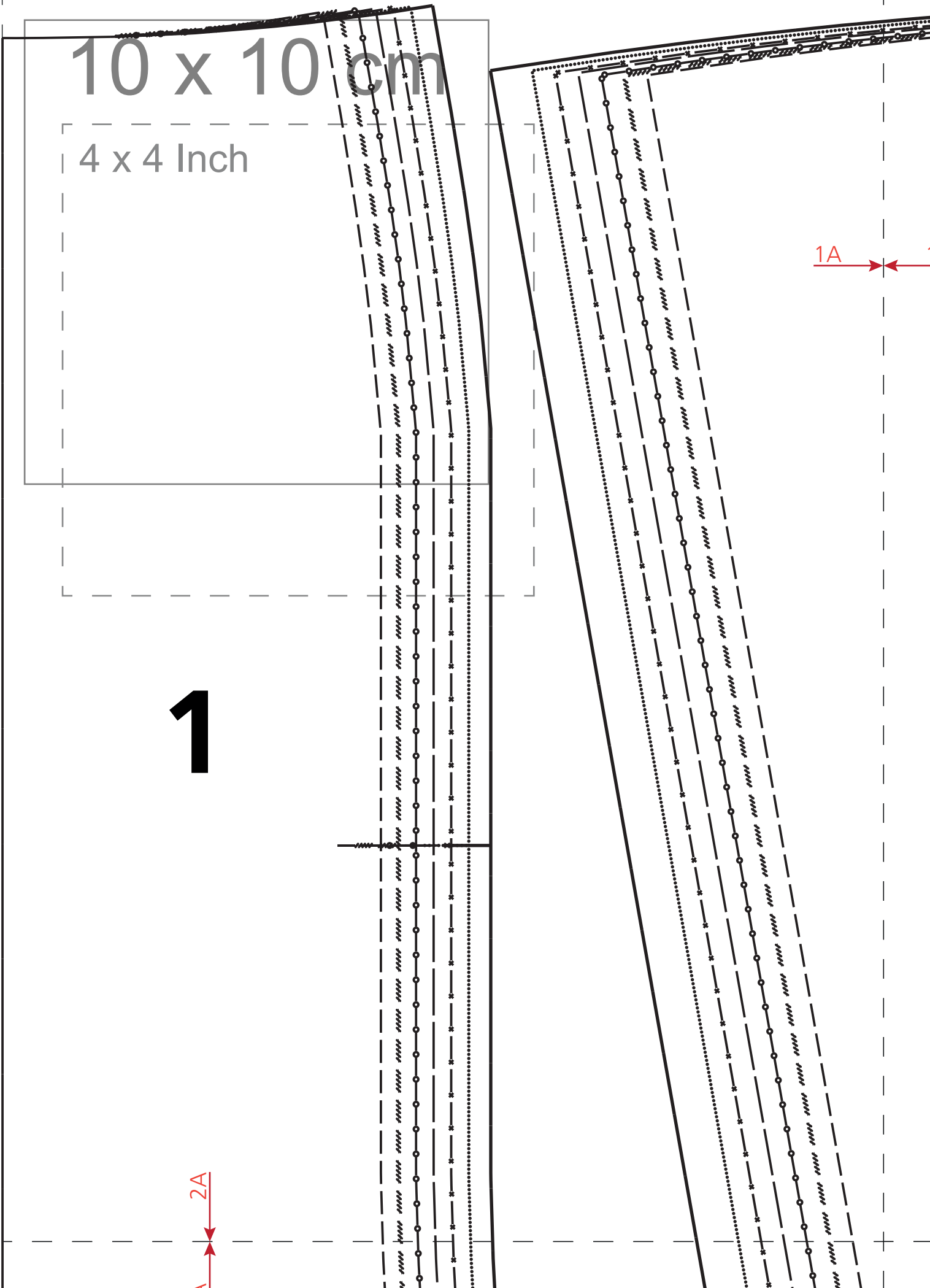

A

1A

1B

Skirt „Diamond“ 323-13

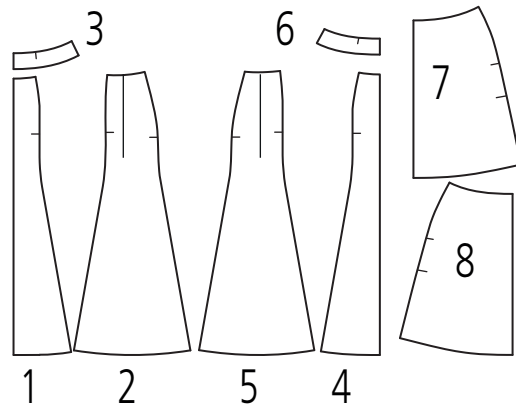
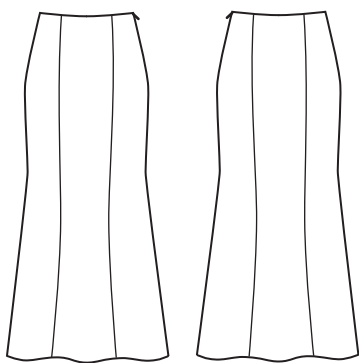

2B

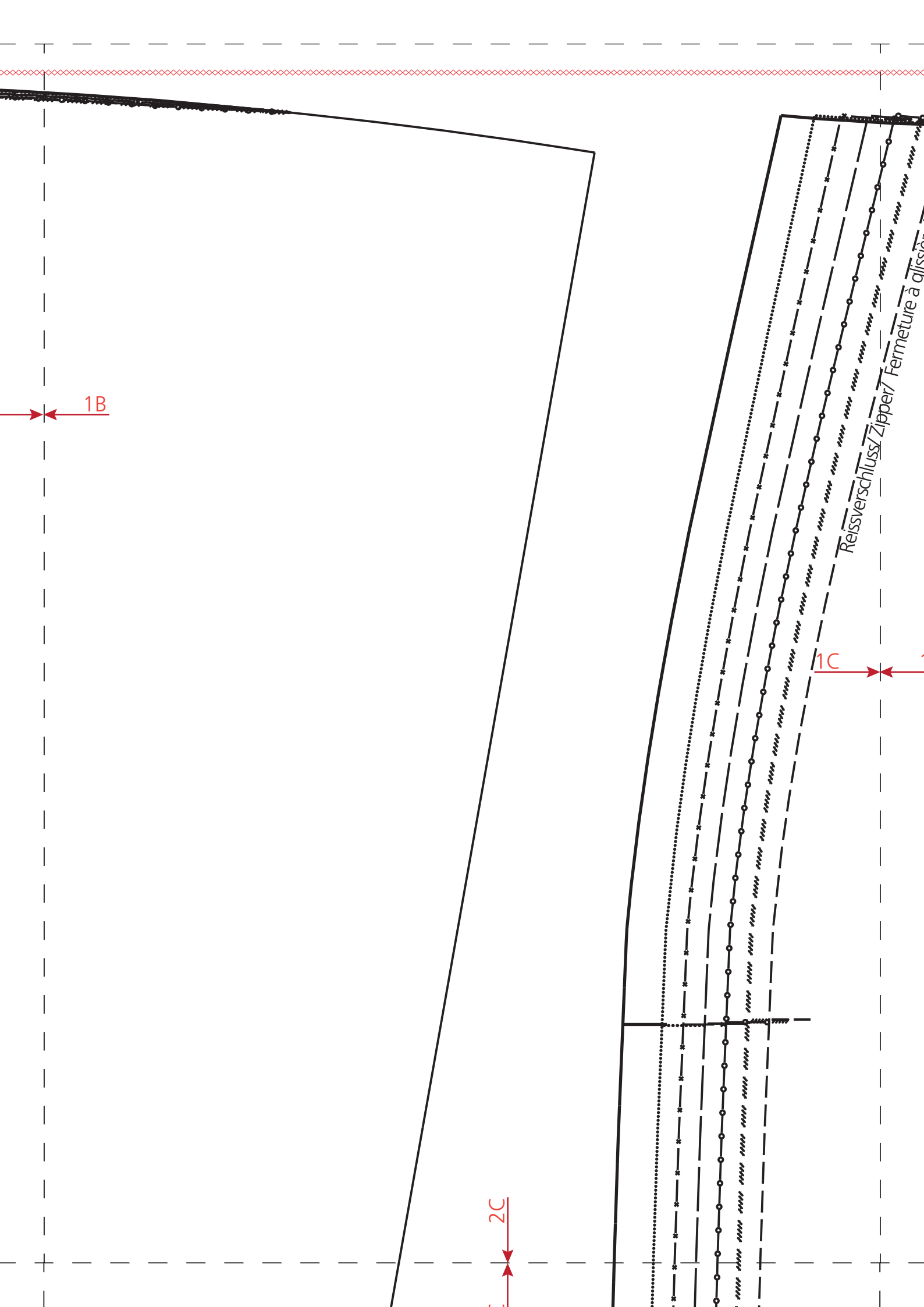

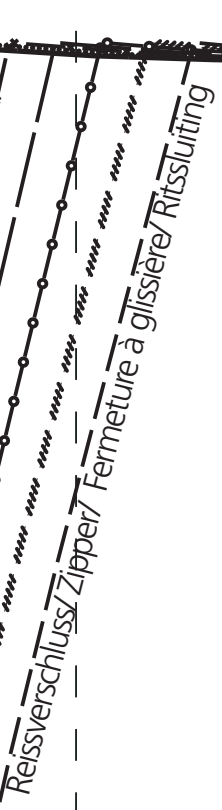

Fadenlauf/ Straight grain/ Droit fil/ Draadrichting

2D

1D

Vord. M. Stoffbr. Faden/
C. fr. fold str. grain/

Vord. M. Stoffbr. Fadenl/
C. fr. fold str. grain/
Mil. endr. pli droit fil/
Middenv. stofv. draadr.

3

1E

2E

1D

0

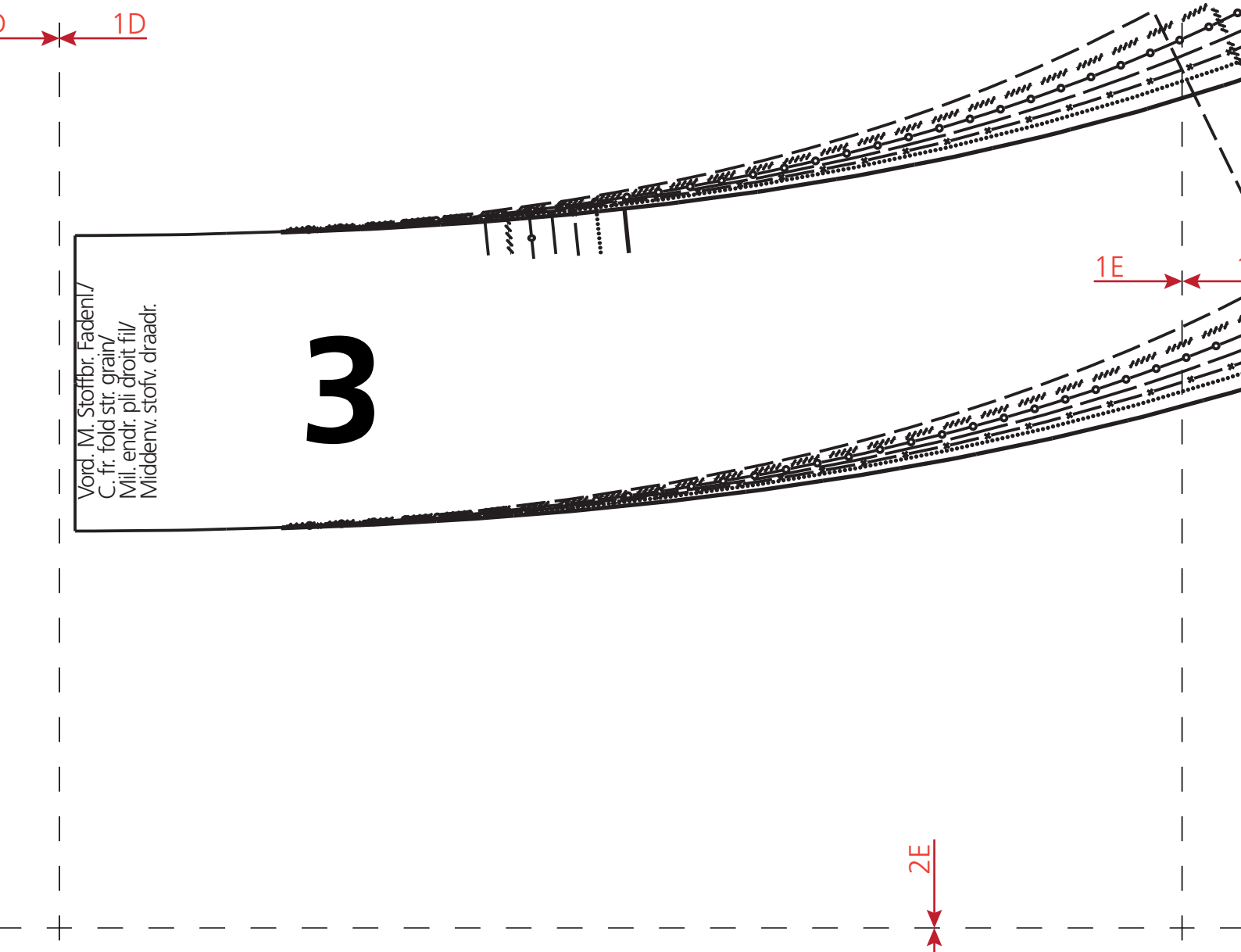
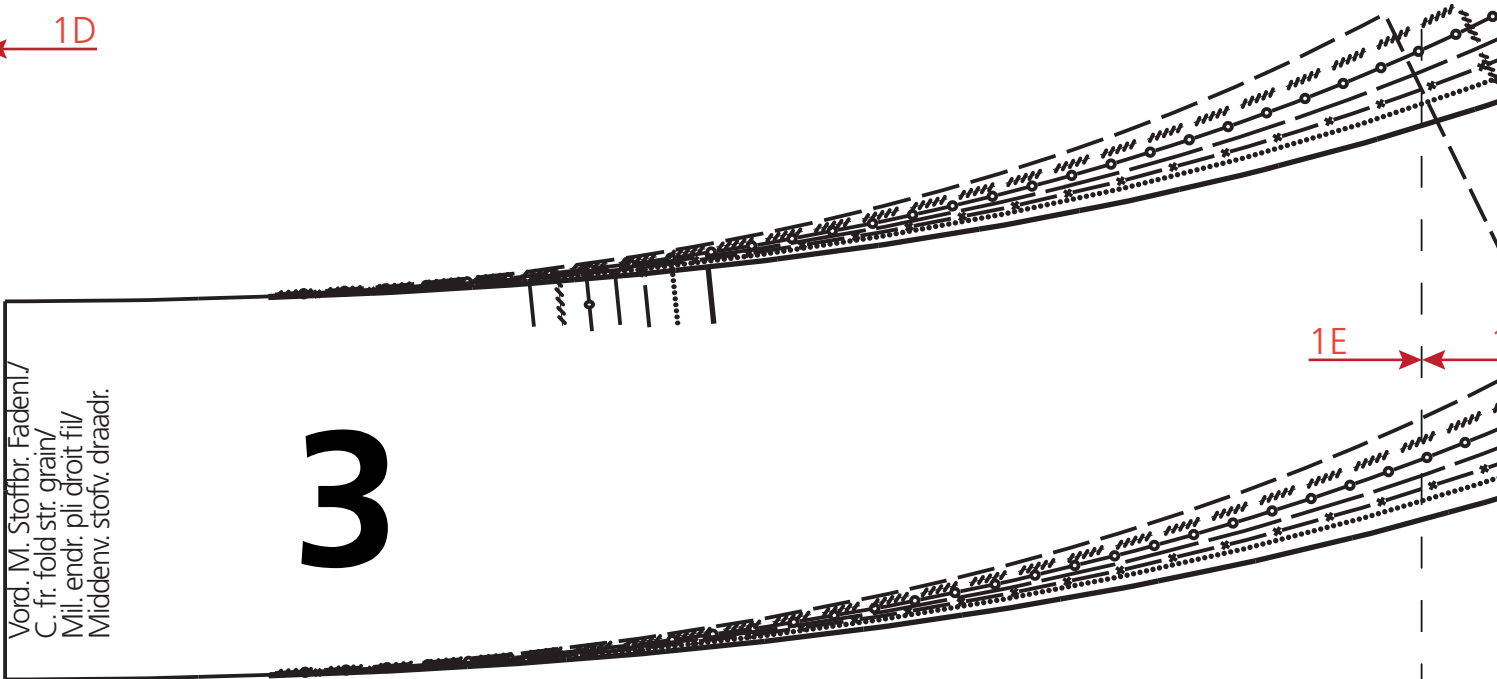
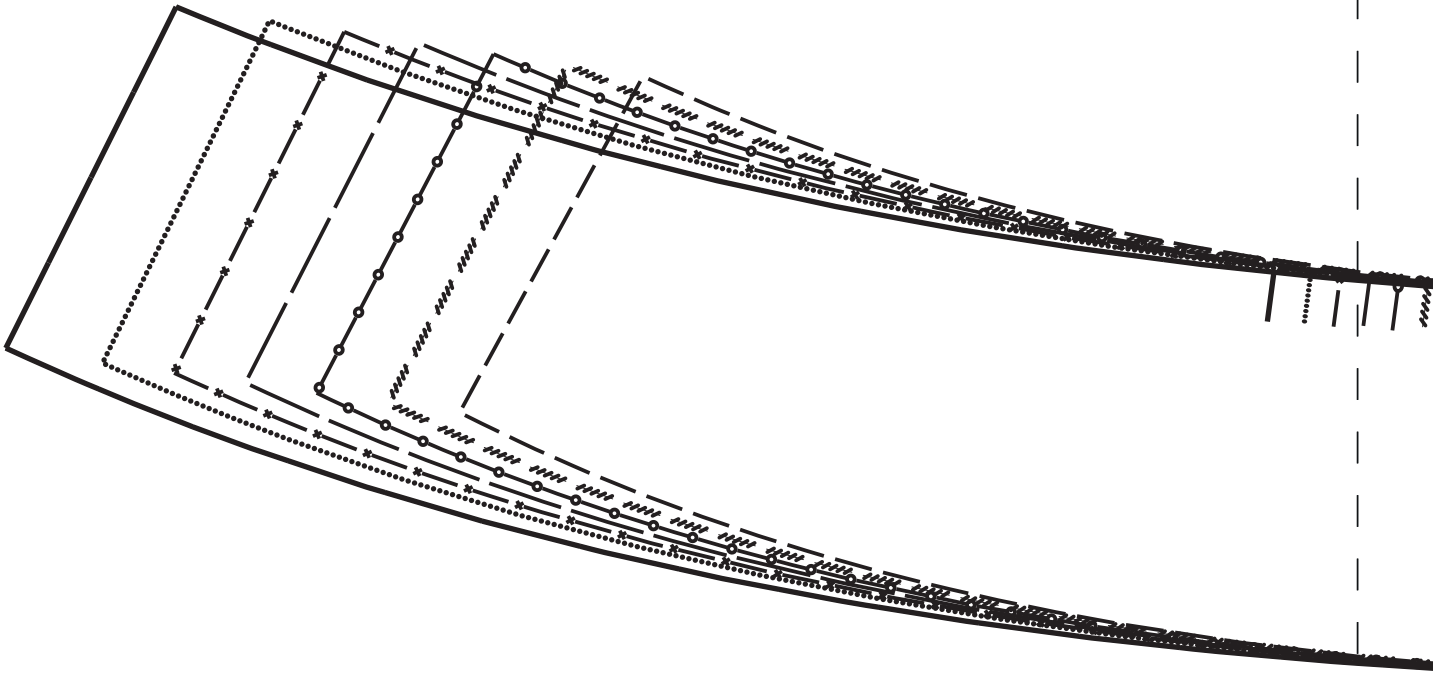

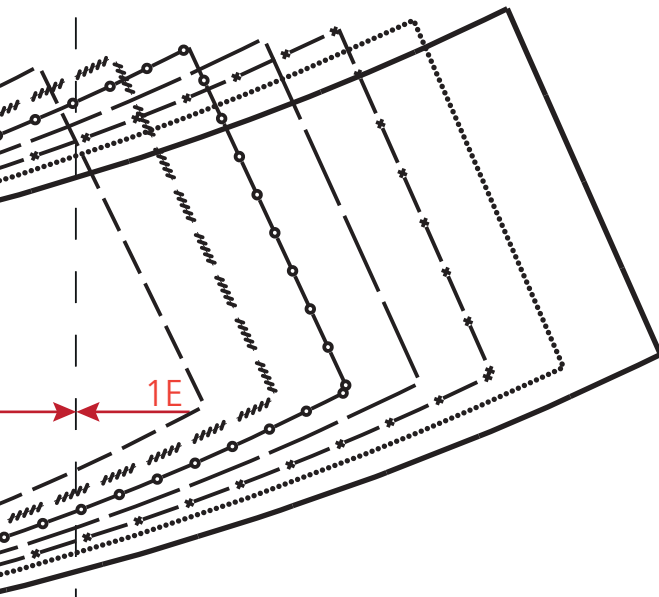

6

Rückw. M. Stoffbr. Fadenl. /
 Centre back fold str. grain /
 Milieu envers pli droit fil /
 Middena. stofv. draadrichting

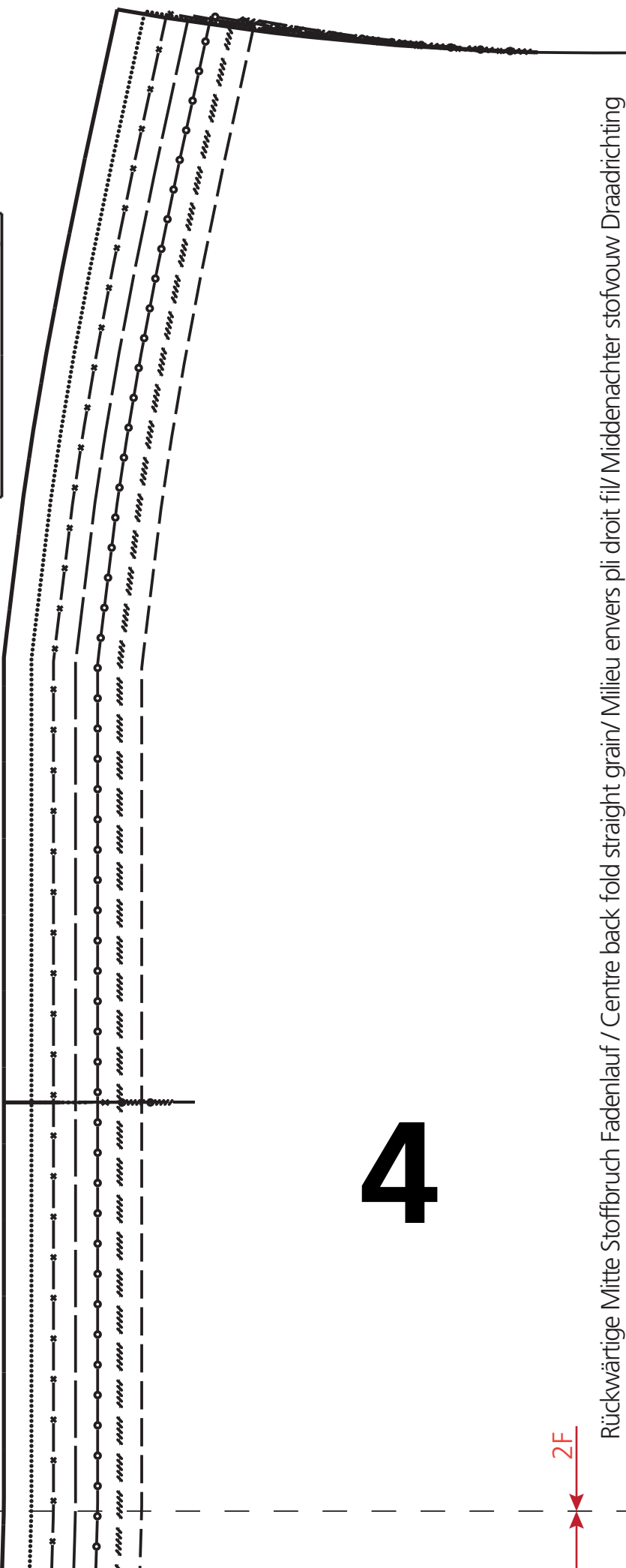

4

2F

Rückwärtige Mitte Stoffbruch Fadenlauf / Centre back fold straight grain / Milieu envers pli droit fil / Middenachter stofvouw Draadrichting

Vordere Mitte Stoffbruch Fadenlauf/ Centre front fold straight grain/ Milieu endroit pli droit fil/ Middenvoor stofvouw draadrichting

2A

3A

2A



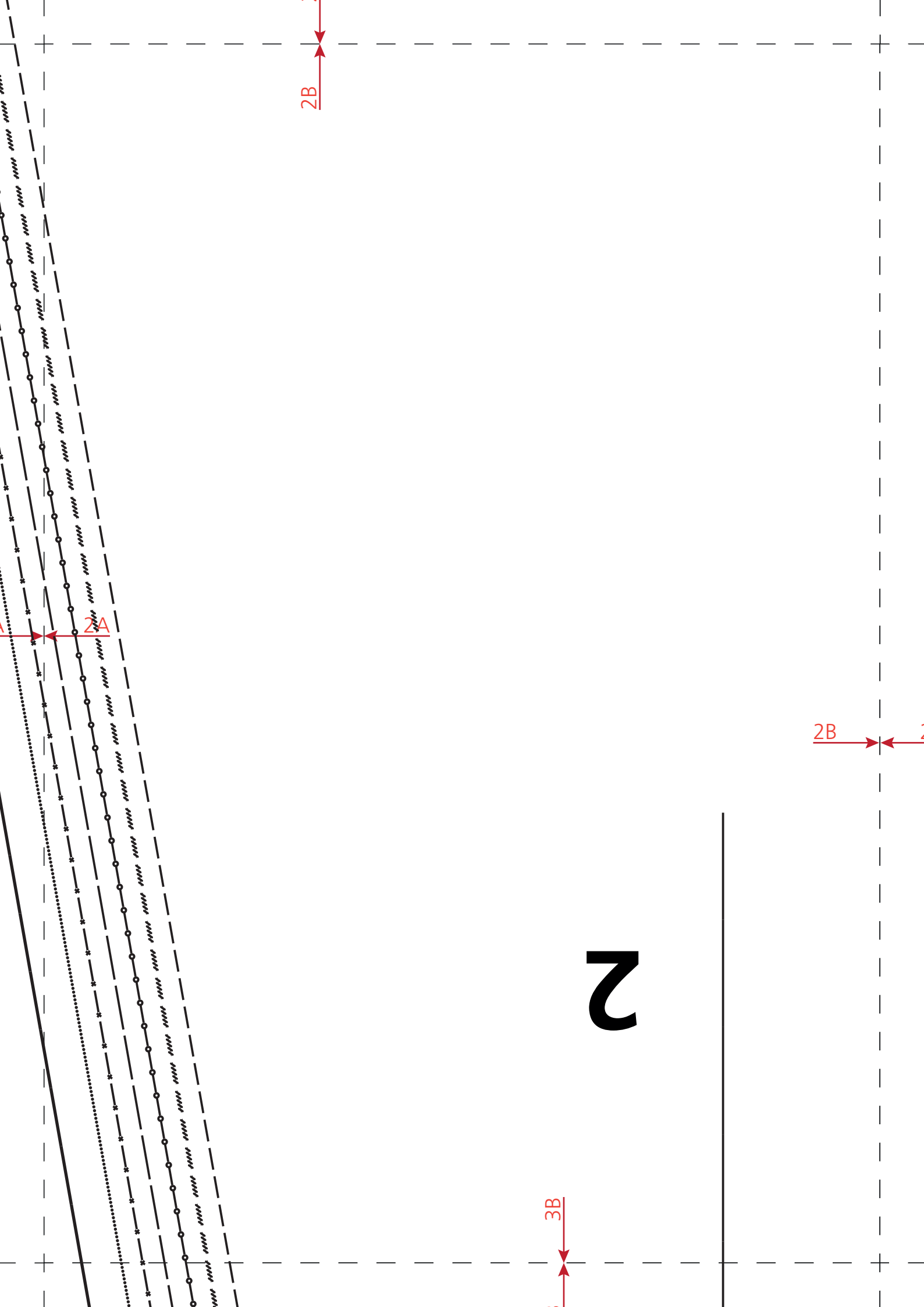

$2B$

$2A$

$2B$

2

$3B$

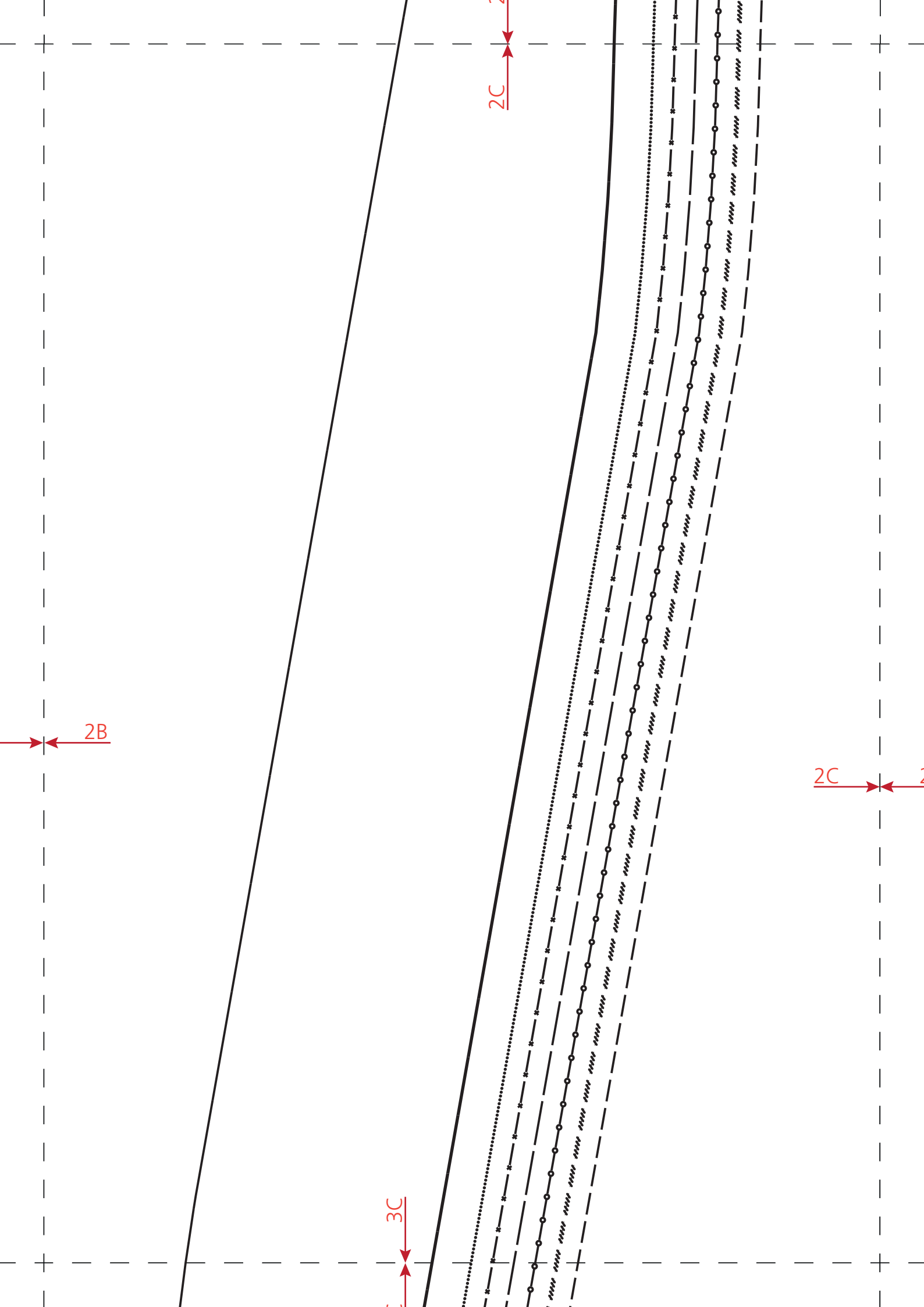

5

$2C$

$2D$

$2D$

$3D$

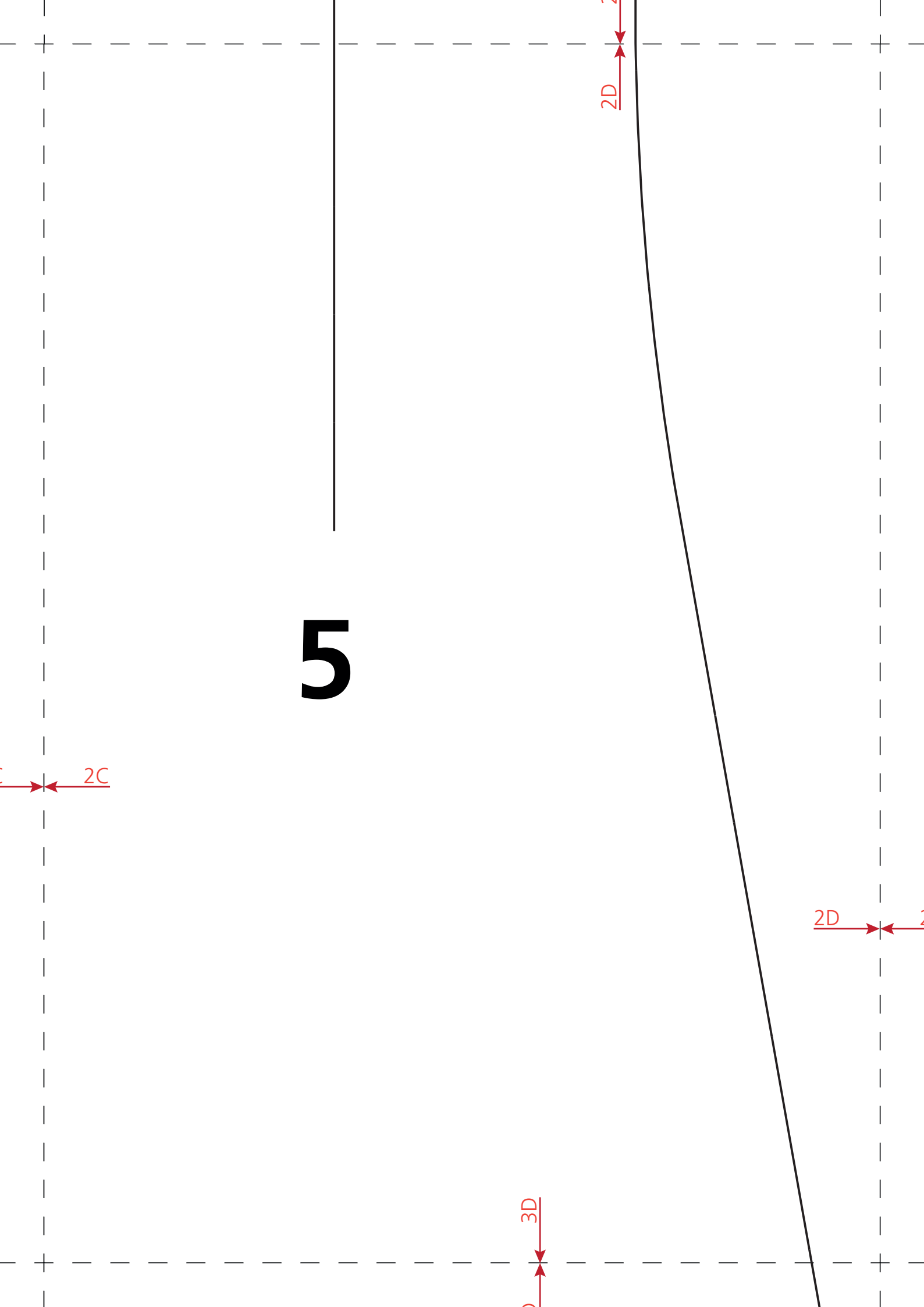

2E

Für Körpergröße/ for height/ pour la taille/ Maten voor lichaamsgrootte 168 cm								
Größe/ Size/ Taille/ Maat	34	36	38	40	42	44	46	48
Oberweite/Bust/ Poitrine/ Bovenwijdte	80	84	88	92	96	100	104	110
Taillenweite/ Waist/ Taille/ Tailienwijdte	64	67	71	75	79	83	87	93
Hüftweite/ Hip/ Hanche/ Heupwijdte	90	93	96	99	102	105	108	114
Vord. Taillenlg./ Front waist length/ Longueur taille devant/ Taillelengte voor	42	43	44	45	46	47	48	49
Rückw. Taillenlg./ Back waist lenth/ Longueur taille dos/ Ruglengte tot taille	41	41	41	42	42	42	42	43

Legende/ Legend/ Légend	
Größe/	--- 34
Size/	--- 36
Taille/	38
Maat	—○— 40
	— 42
	— * — * — * 44
 46
	———— 48

For height 66 Inch:	34	36	38	40	42	44	46	48
Taille	31,5	33,0	34,6	36,2	37,8	39,4	40,9	43,3
Bust	31,5	33,0	34,6	36,2	37,8	39,4	40,9	43,3
Waist	25,2	26,4	28,0	29,5	31,1	32,7	34,3	37,0
Hip	35,4	36,6	37,8	39,0	40,2	41,3	42,5	44,9
Front waist length	16,5	17,0	17,3	17,7	18,0	18,5	18,9	19,2
Back waist lenth/	16,0	16,0	16,0	16,5	16,5	16,5	16,5	16,9

Wichtig: Alle Schnittteile sind ohne Nahtzugabe, falls nichts anderes vermerkt ist!

Important: All patterns are without seam allowances, unless otherwise indicated!

Important: Toutes découpes sont sans surplus de couture (sauf mention contraire)!

Attentie: Alle patroondeelen zijn zonder naadtoeslag, tenzij anders vermeld!

2D

2E

3E

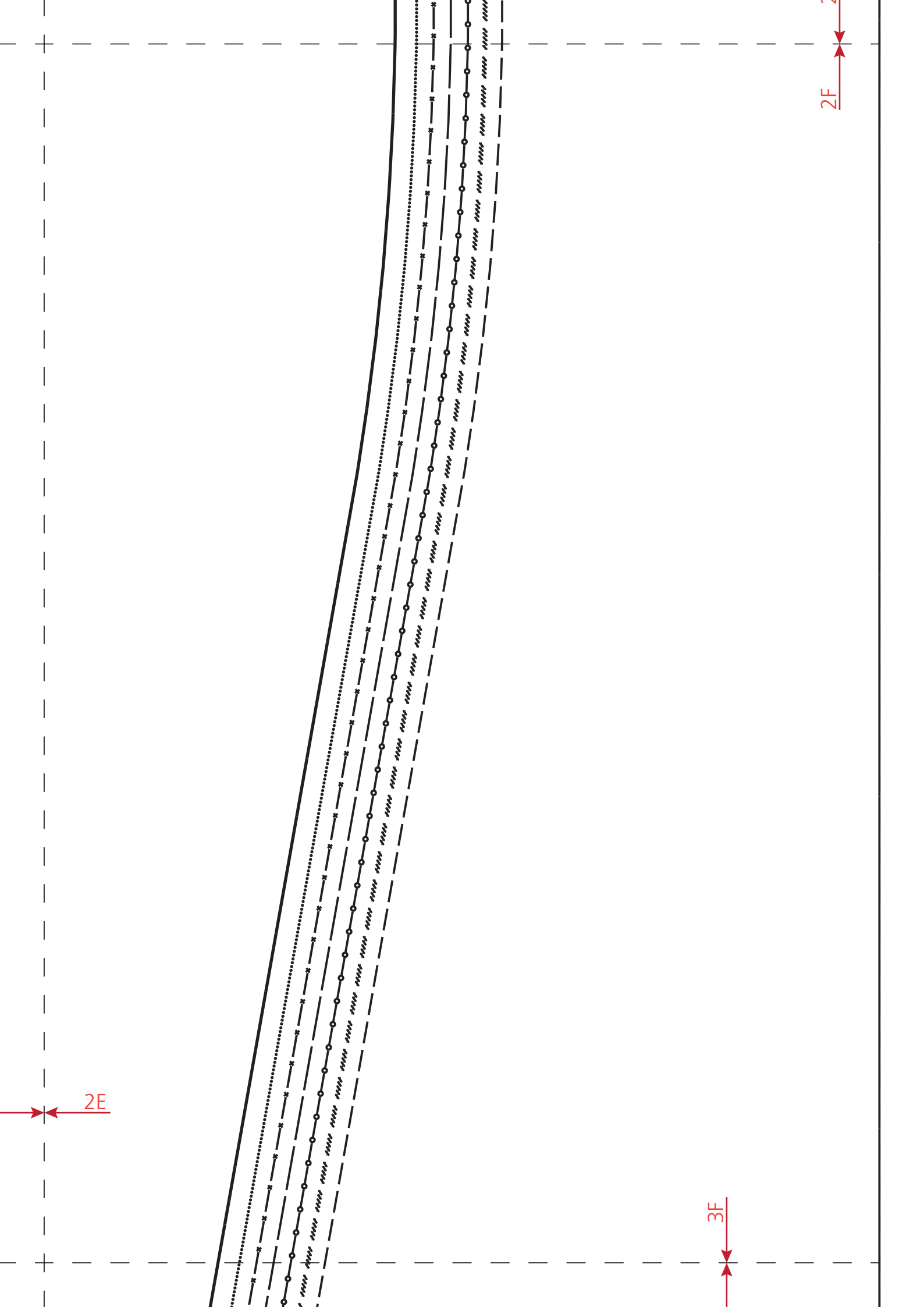

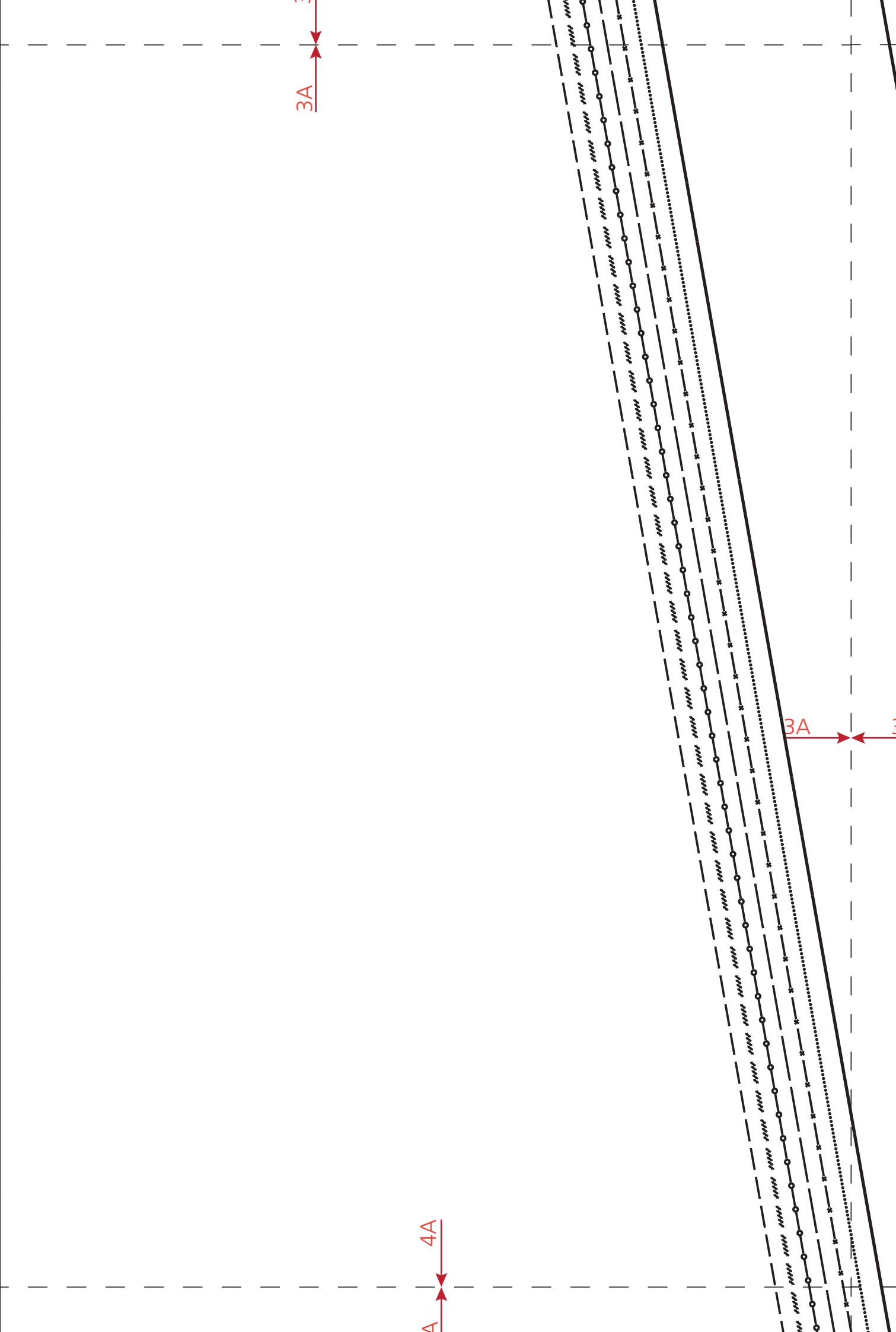

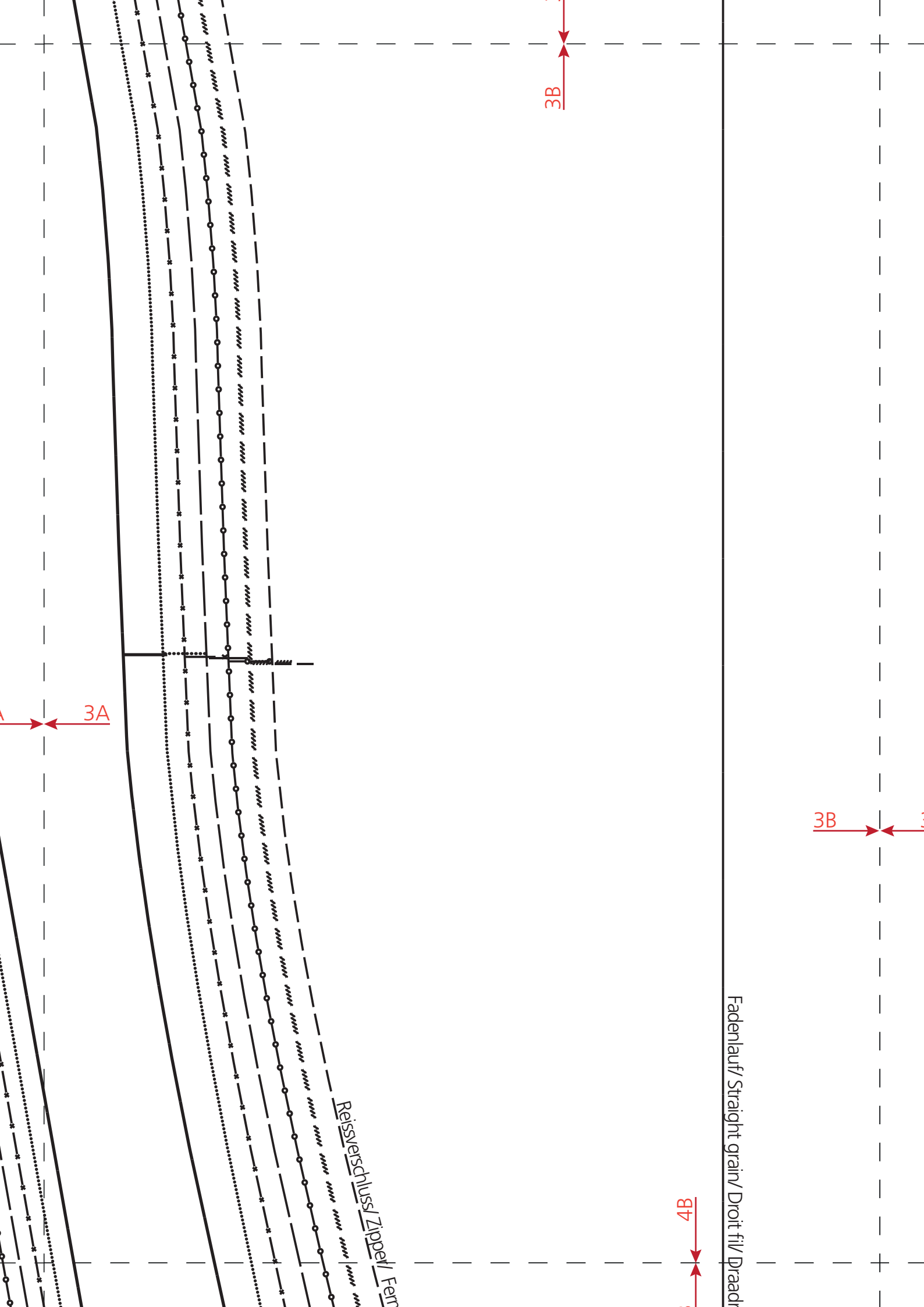

3A

3B

3B

4B

Reissverschluss/Zipfel/Ferr

Fadenlauf/ Straight grain/ Droit fil/ Draadr

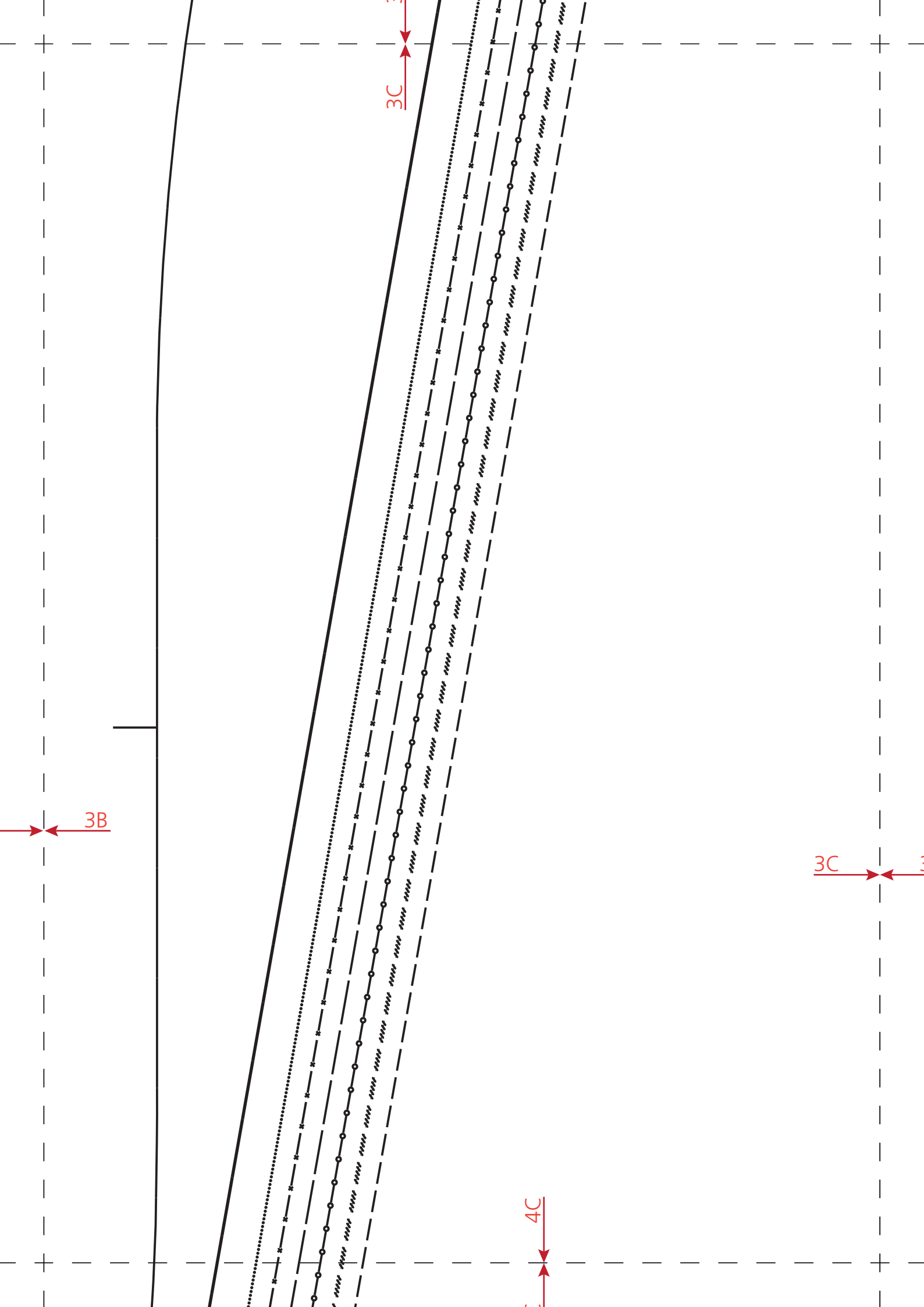

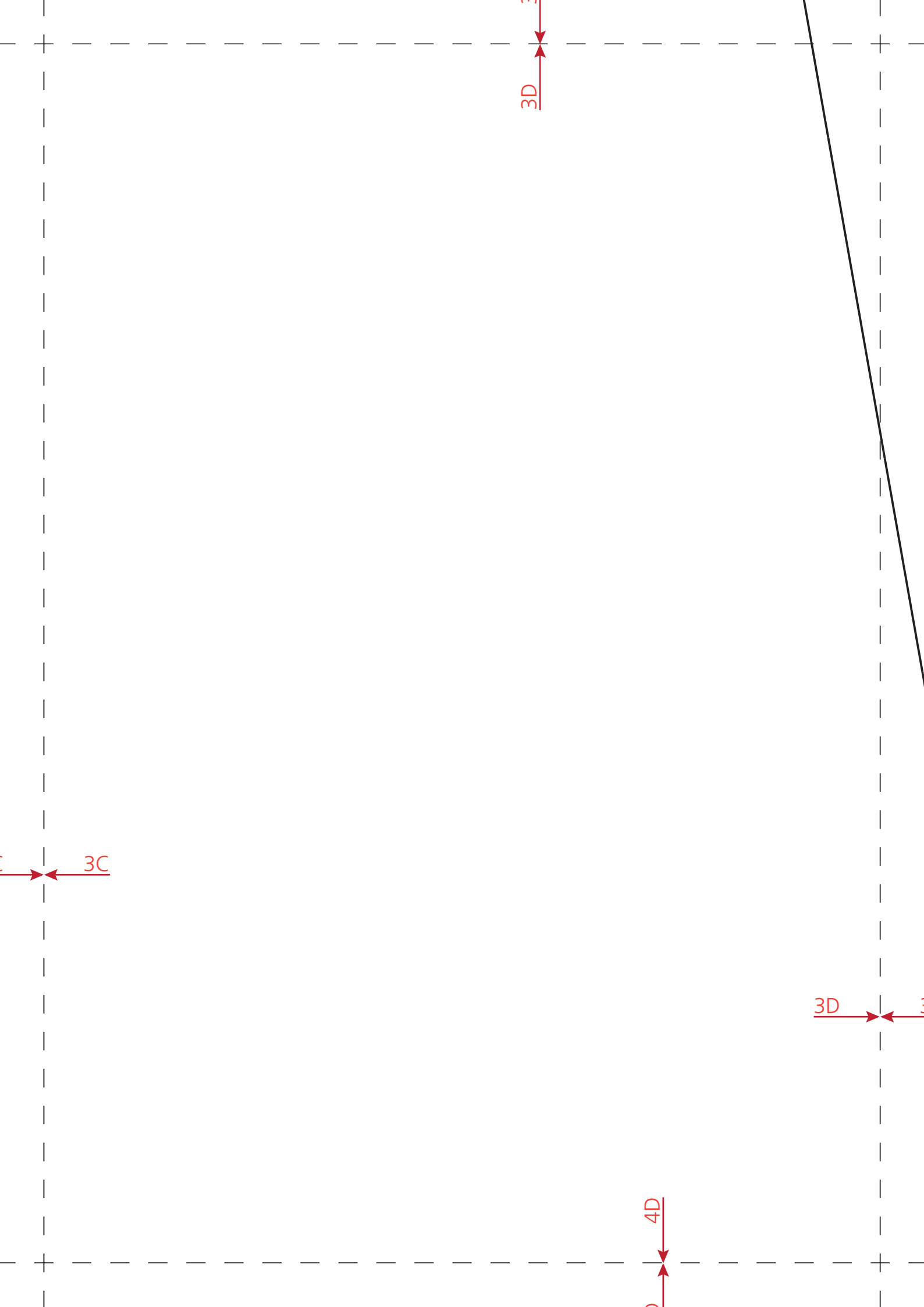

Keine Inspiration mehr versäumen – mit einem Abo!
No more missing inspiration – with a subscription!



Ja, ich möchte die Inspiration ab der nächsten Ausgabe für 1 Jahr abonnieren (3 Hefte pro Jahr).

Yes, I would like to subscribe to Inspiration from the next issue for 1 year (3 issues per year).

Jeweils im Januar erscheint das Frühjahrsheft, im Mai das Sommerheft und im September die Herbst/Winterausgabe. In allen Ausgaben sind Schnittmuster enthalten.

The spring issue is published in January, the summer issue in May and the autumn/winter issue in September. All issues contain pattern plans.

Land/ Country Print Digital (nur online buchbar/
bookable only online) Sprache/ Language

- | | | | |
|--|---------------|---------------------|--|
| <input type="checkbox"/> Schweiz/ Switzerland | CHF 27 | CHF 15 | <input type="checkbox"/> Deutsch/ German |
| <input type="checkbox"/> Europa/ Europe | EUR 24,50 | EUR 12 | <input type="checkbox"/> Englisch/ English |
| <input type="checkbox"/> Übersee/ Overseas | USD 40/AUD 56 | USD 16,50/AUD 25,50 | <input type="checkbox"/> Französisch/ French |
| alle Preise inkl. MwSt. und Porto/ All prices inclusive of VAT and postage | | | |
| <input type="checkbox"/> Niederländisch/ Dutch | | | |

Name

Geburtsjahr (optional)/ Year of birth (optional)

Strasse, Nr./ Street, no.

PLZ, Ort/ Postal code, town

Mein Abonnement beginnt mit der jeweils nächsten Ausgabe. Es läuft nach Erhalt von 3 Heften automatisch weiter, sofern ich nicht rechtzeitig vor Ablauf künde.

Subscriptions normally begin with the next issue. Subscriptions are automatically renewed after 3 issues if not cancelled in time before their expiry.

Ich bin damit einverstanden, dass BERNINA meine Daten zur Weiterverarbeitung an Dritte (insb. die medienwerkstatt ag, Schweiz) übermittelt, sofern dies erforderlich ist, um die vertragliche Leistung in Anspruch nehmen zu können.

I agree that BERNINA may transfer my data to third parties (esp. the media workshop AG, Switzerland and Datatrans AG, Switzerland), if this is required in order to make use of the contractual service.

Ich bin damit einverstanden, dass meine Daten für Zwecke der Direktwerbung von BERNINA verarbeitet und mit anderen Informationen, die von BERNINA für denselben Zweck erhoben wurden, verknüpft werden. Weitere Informationen kann ich in der Datenschutzerklärung (bernina.com) einsehen. Diese Einwilligung kann ich jederzeit kostenfrei widerrufen.

I agree that my data will be processed for direct marketing purposes by BERNINA and will be linked with other information which have been collected by BERNINA for the same purpose. I can find further information in the privacy policy (bernina.com). I can revoke this consent free of charge at any time.

**BERNINA International AG, Redaktion Inspiration, CH-8266 Steckborn, www.inspiration.bernina.com
 E-Mail: inspiration@bernina.com**

3E

3E

3D

4E

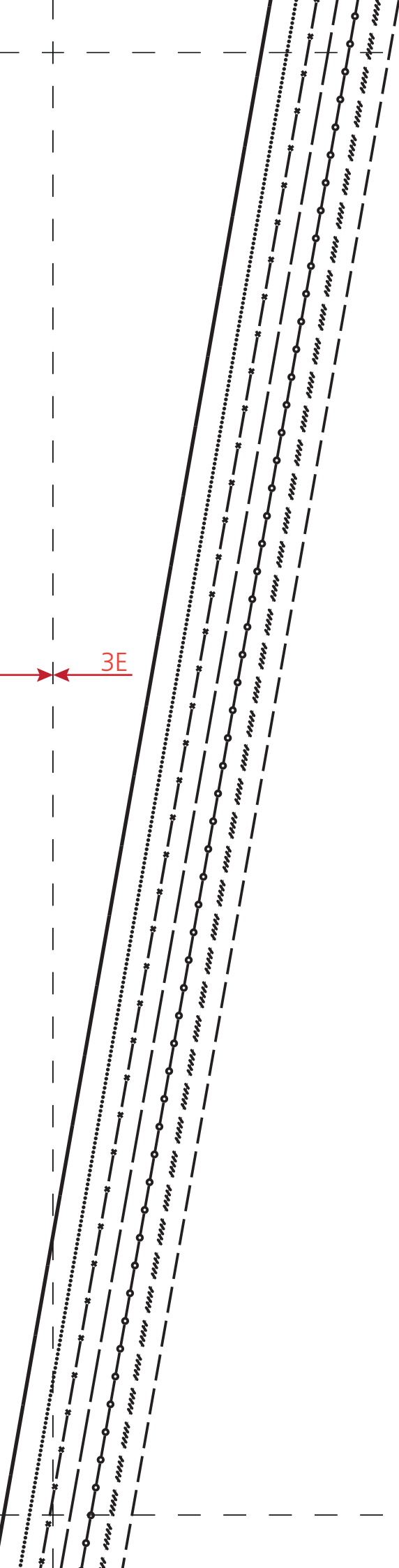

$3E$

$4F$

$3F$

4A

4A

5A

Schlitz / Slit / Fente / Split

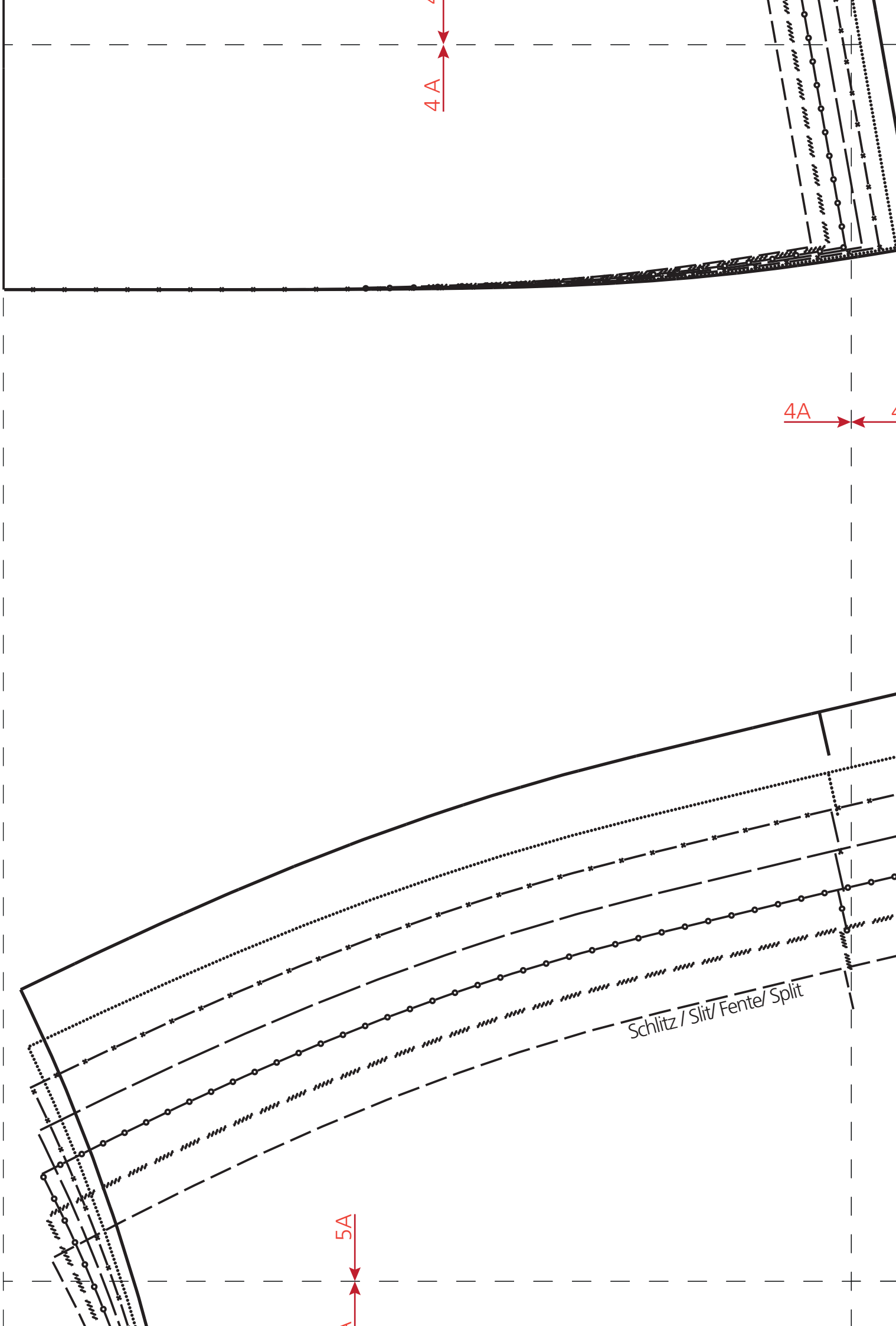

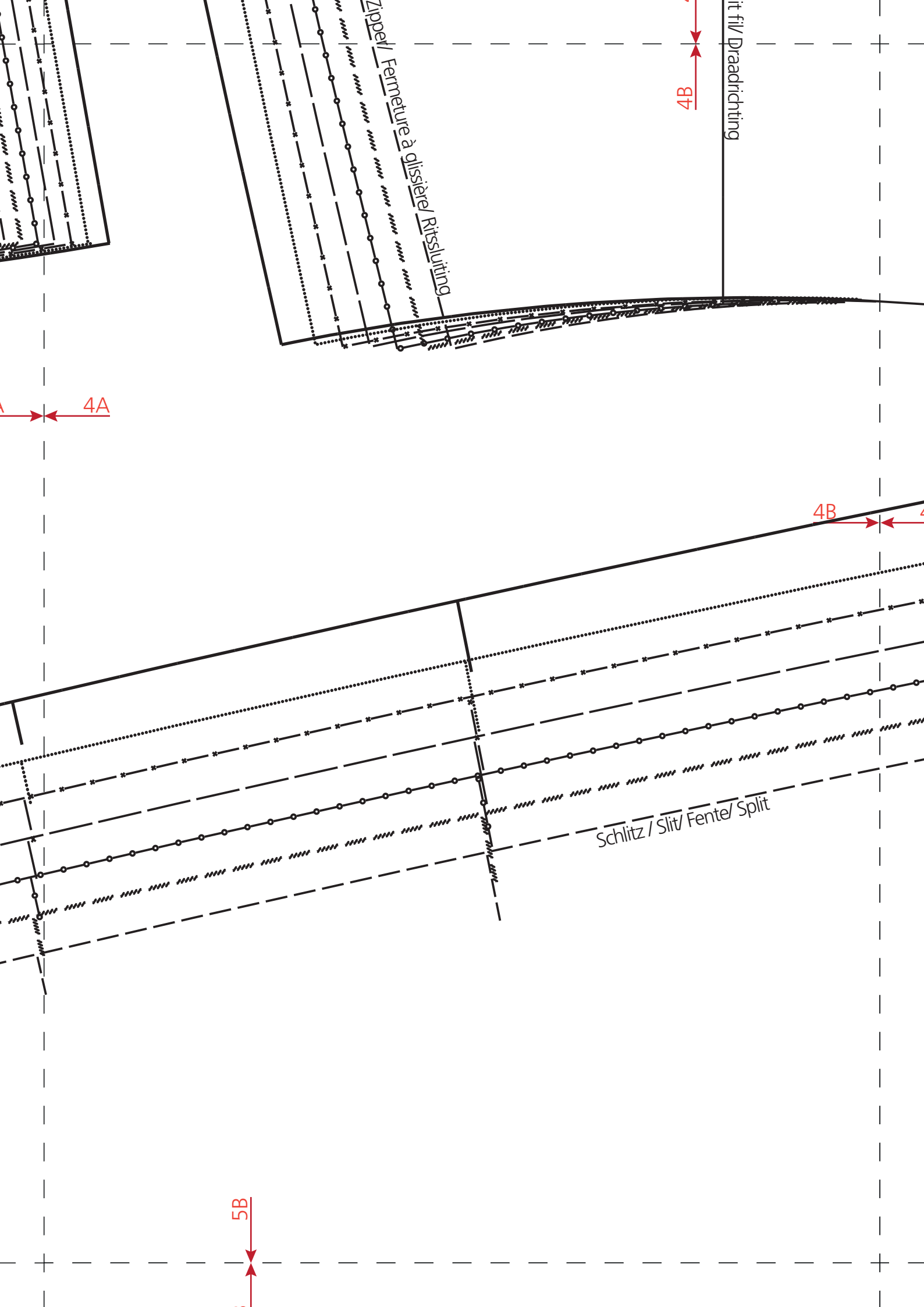

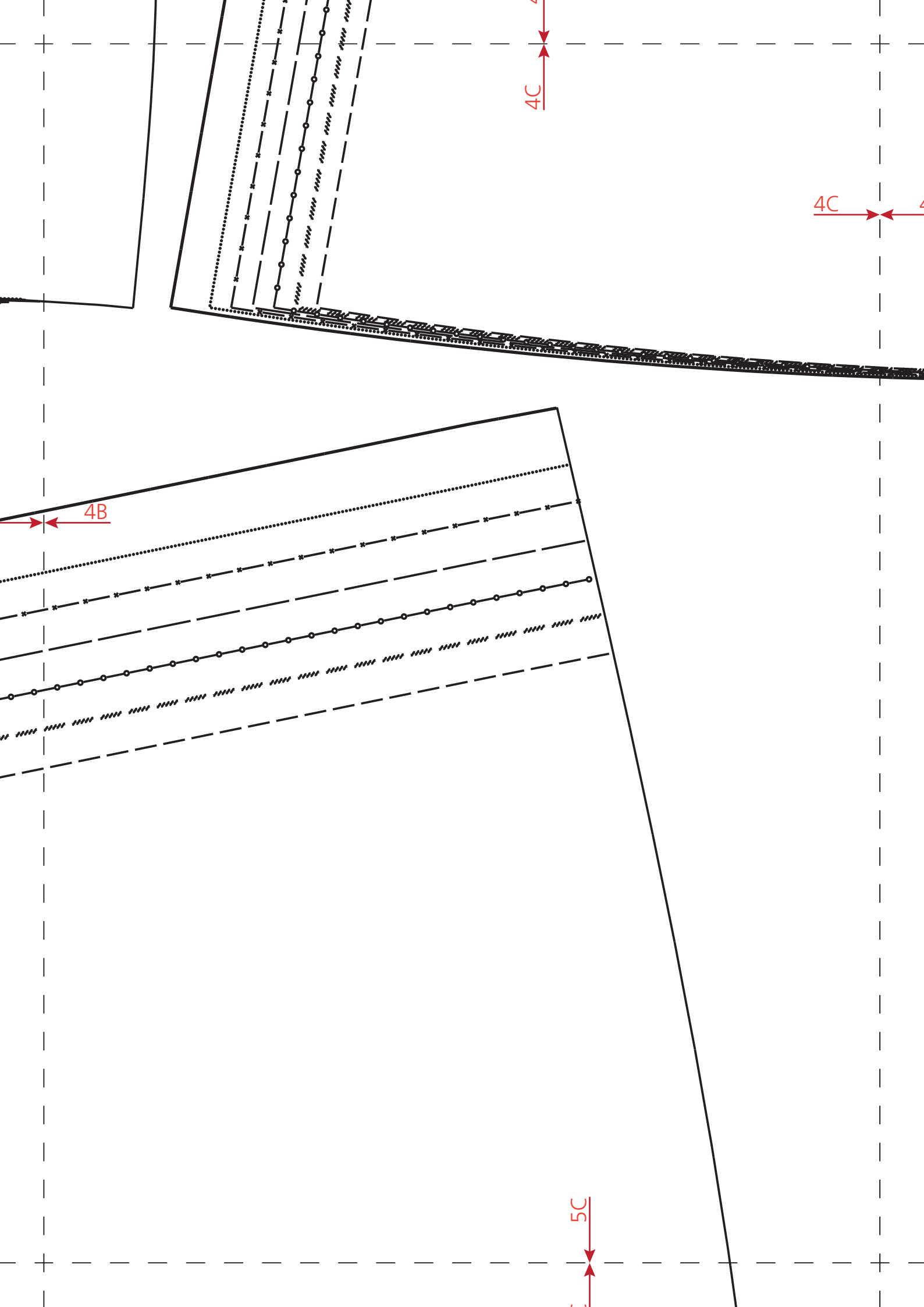

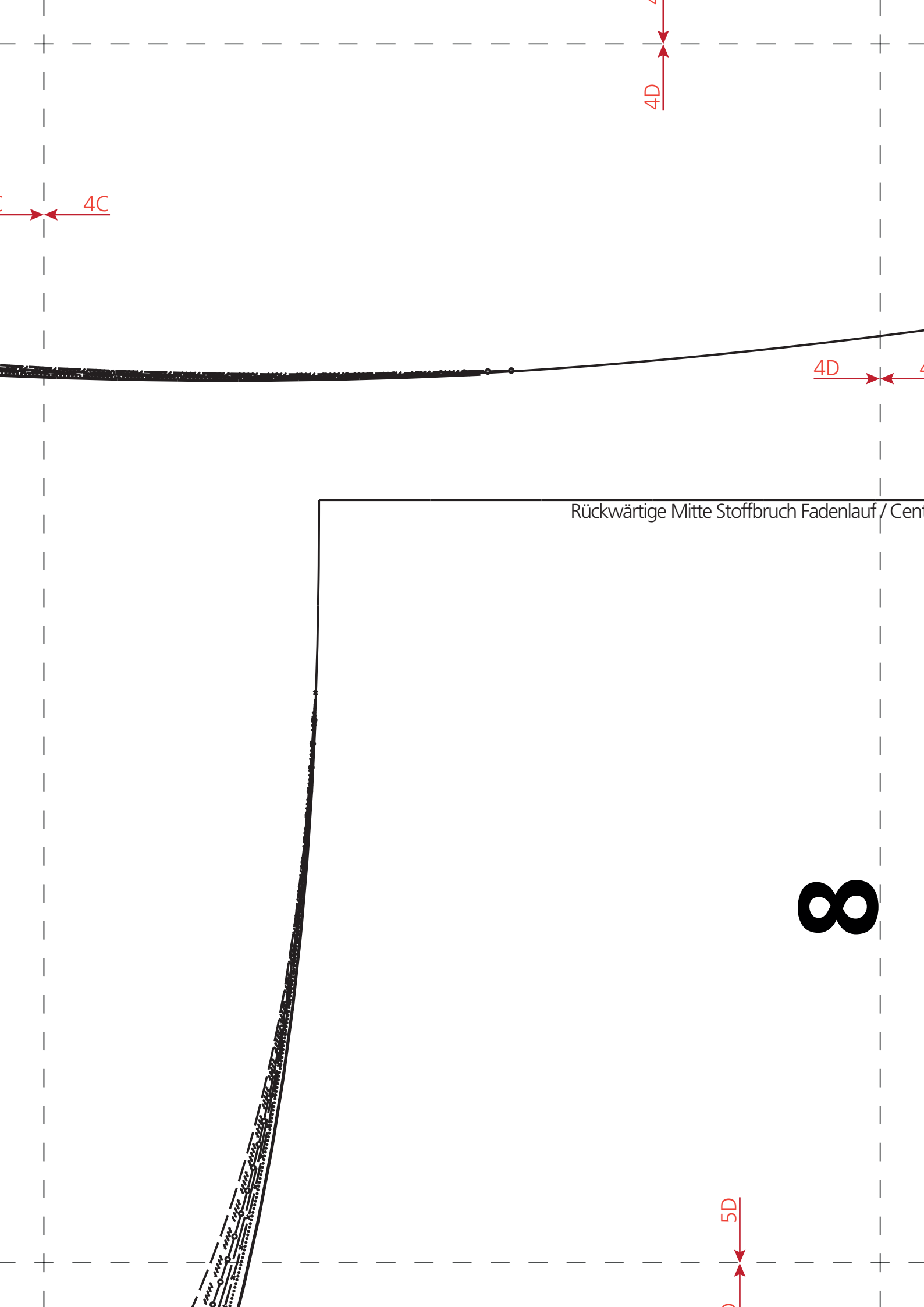

4C

4D

4D

Rückwärtige Mitte Stoffbruch Fadenlauf / Cent

8

5D

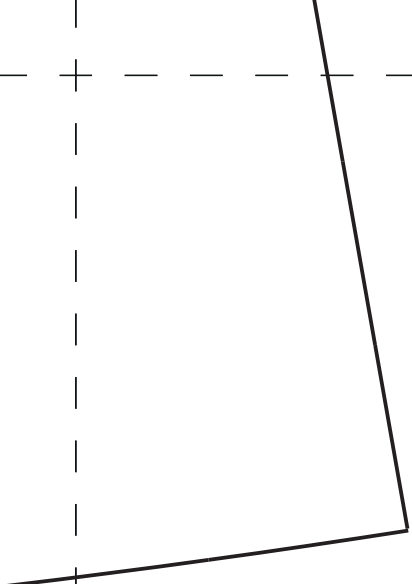

4E

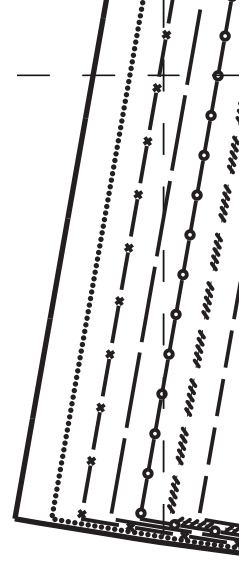

nlauf / Centre back fold straight grain / Milieu envers pli droit fil / Middenachter stofvouw Draadrichting

4E



5E

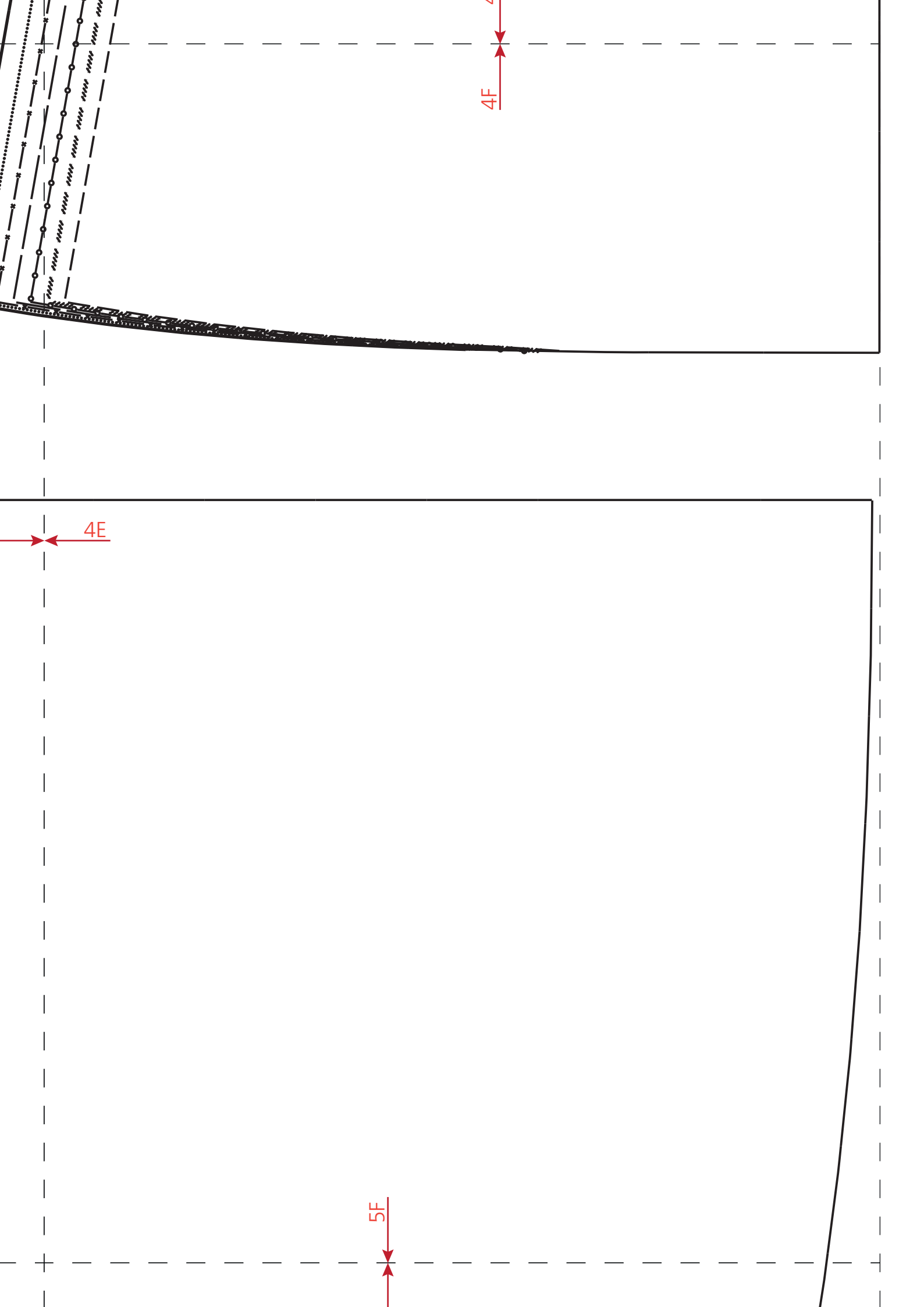

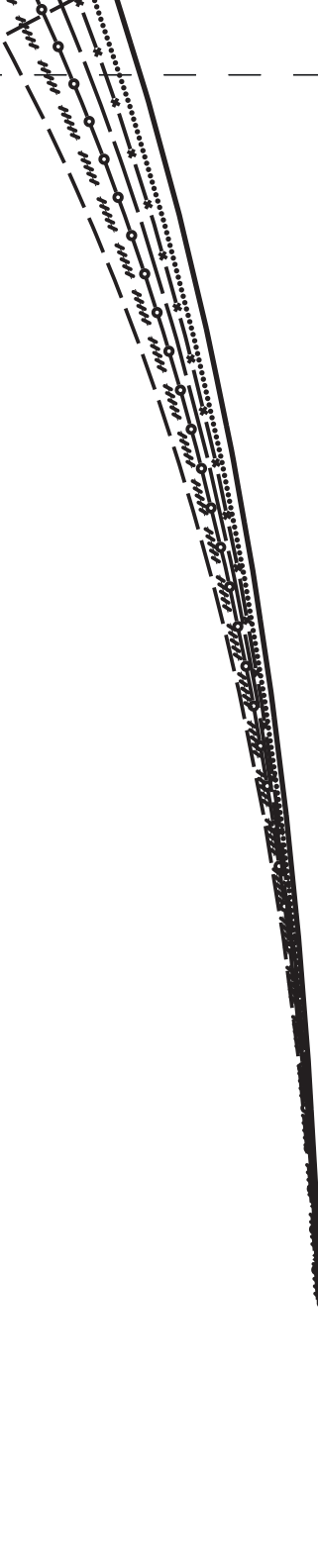

5A

5A

7

Vordere Mitte Stoffbruch Fadenlauf/ Centre front fold straight grain/ Milie



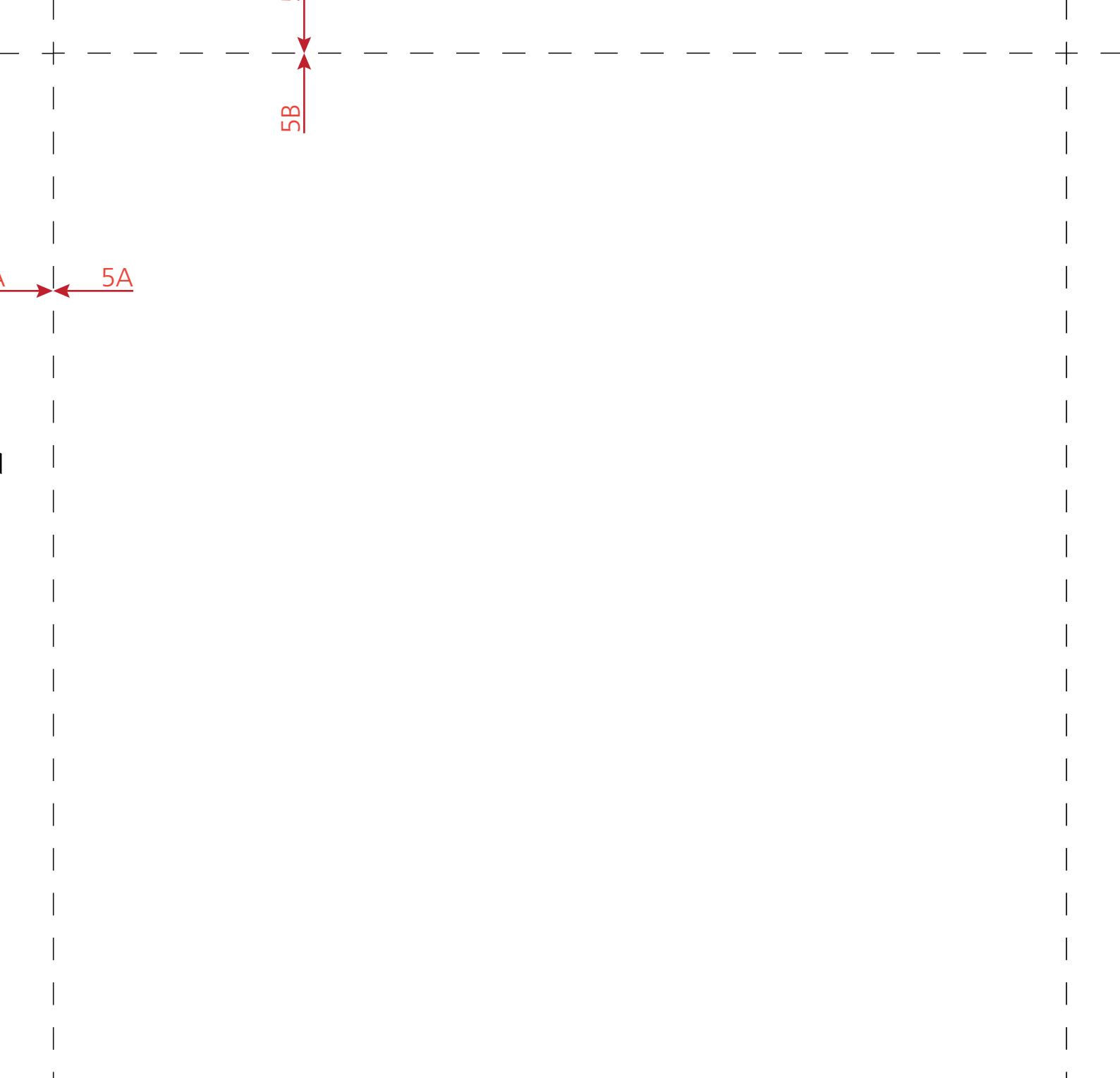

5B

5A

grain / Milieu endroit pli droit fil / Middenvoor stofvouw draadrichting

5B



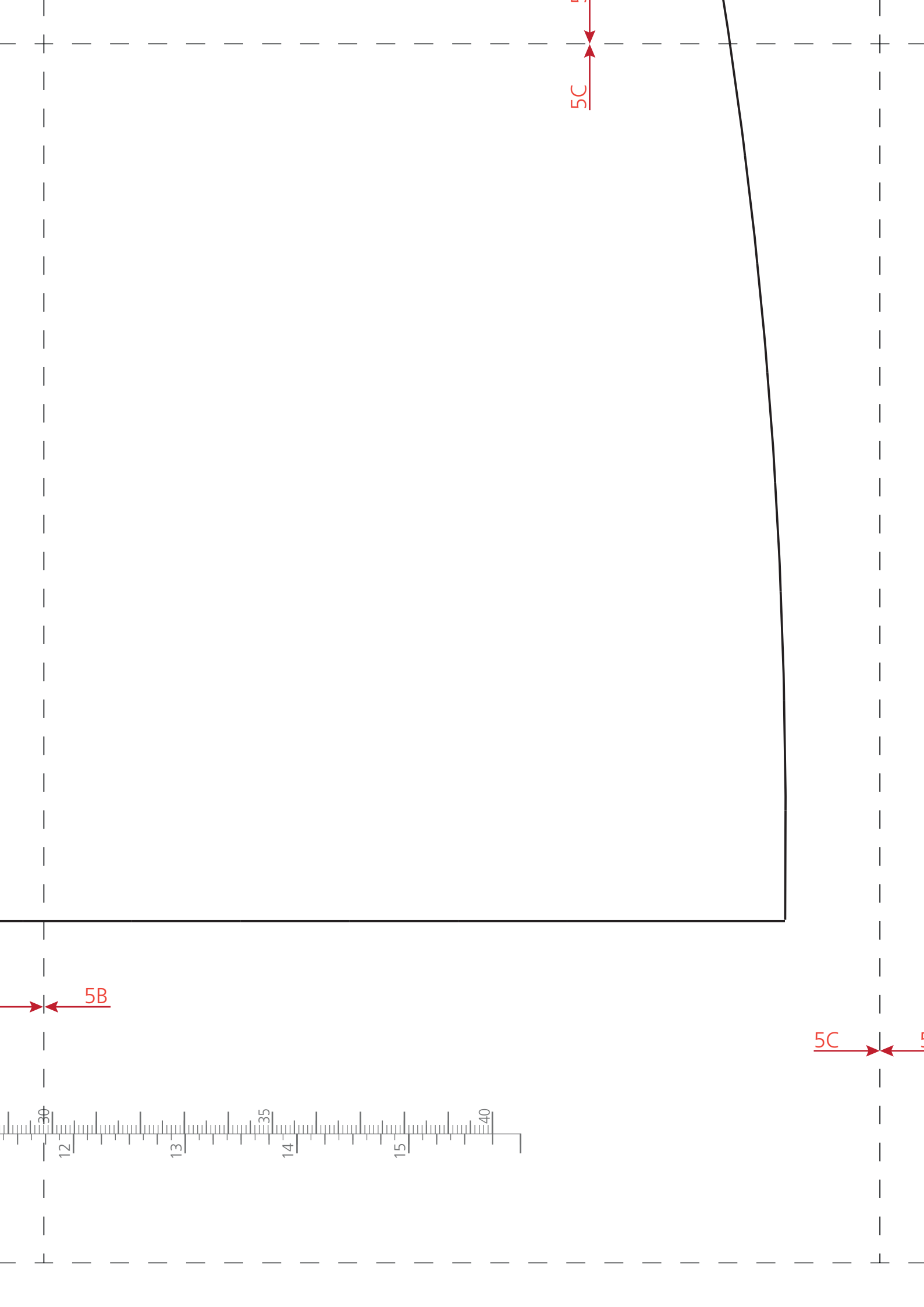

5B

5C

5C

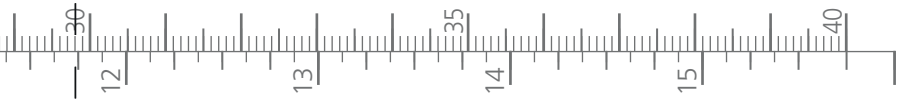

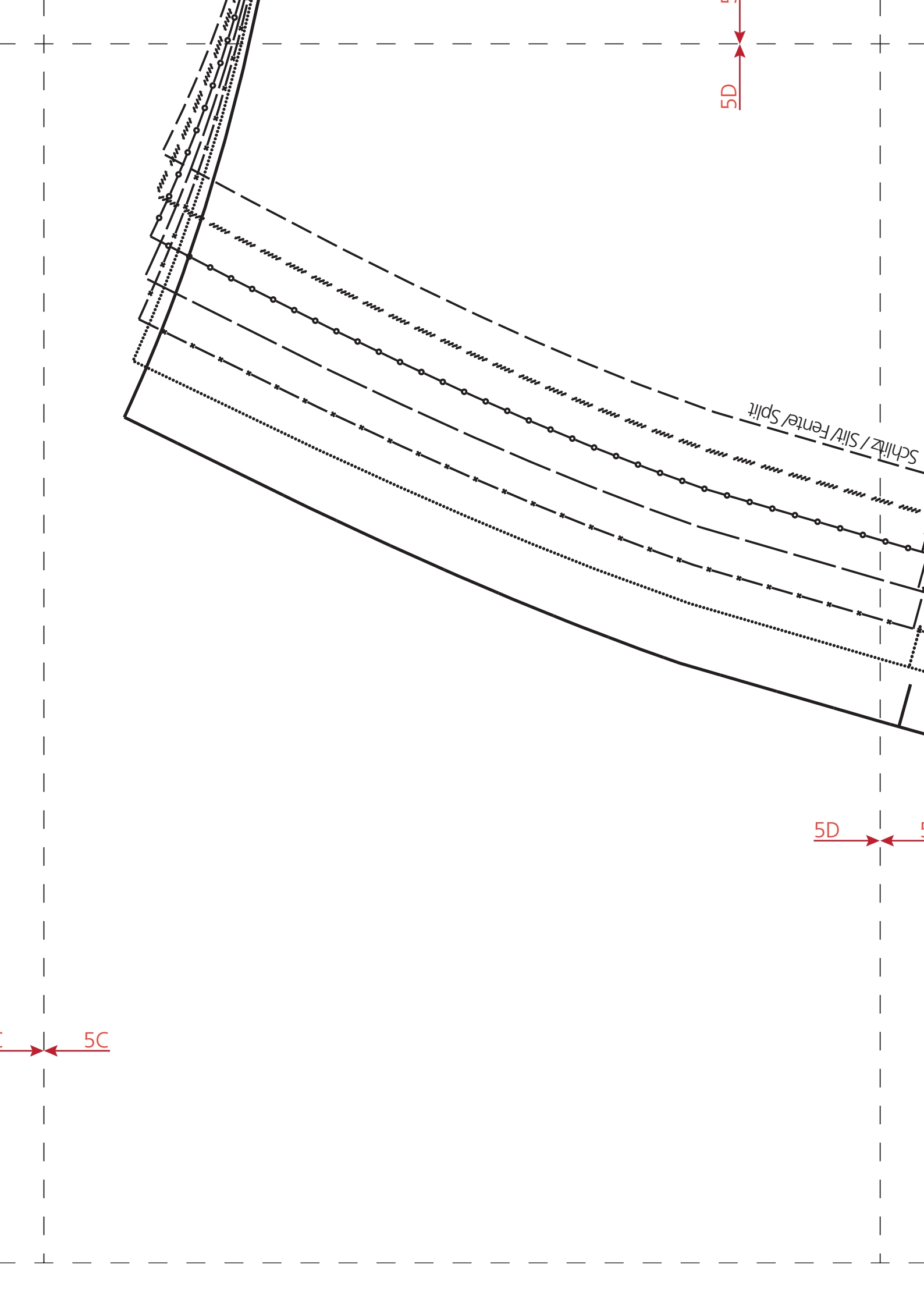

$5C$

$5D$

$5D$

Schlitz / Slit Fente / Split

