

# Sewing Manual artista 170





2-5	<b>Straight stitch, Zig-zag</b>
6	<b>Altered memory</b>
7-11	<b>Practical stitch seams</b>
12, 13	<b>Sewing knits</b>
14	<b>Zippers</b>
15	<b>Long stitch function</b>
16	<b>Basting stitch</b>
17	<b>Blind hem</b>
18, 19	<b>Elastic, cord</b>
20	<b>Bartack program</b>
21-28	<b>Buttonholes</b>
29	<b>Button sew-on program</b>
30	<b>Eyelets</b>
31-34	<b>Mending/darning</b>
35	<b>Decorative stitches</b>
36	<b>Cross stitches</b>
37-39	<b>Quilt stitches</b>
40	<b>Decorative stitches combined with functions</b>
41-43	<b>Practical and decorative stitches in memory</b>
44	<b>Balance</b>
45	<b>Index</b>

# Straight stitch

Stitch: **Straight Stitch No. 1**  
 Needle: **size and type suitable for the fabric selected**  
 Thread: **cotton or polyester**  
 Feed-dog: **up (sewing position)**  
 Presser foot: **Reverse pattern foot No. 1**

## Straight stitch

- the machine is ready to sew as soon as it is turned on
- after the welcome screen (3 seconds), the machine automatically goes to the practical stitch screen with the pre-selected Straight Stitch highlighted

## Screen

- suggests using Reverse pattern presser foot No.1
- basic settings (length and width) for Straight Stitch are preset at 2.25mm (length) and 0mm (width)
- basic settings as well as altered settings are always visible on the screen

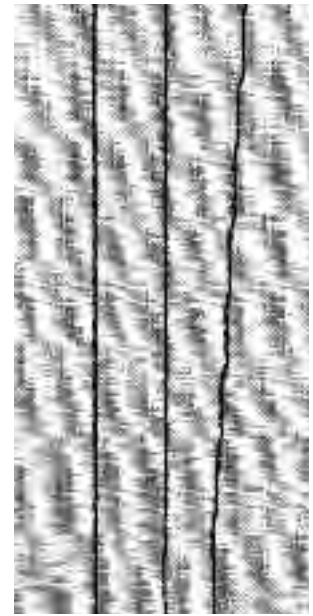

**A B C**

- A** straight stitch with length of 2.25 mm preset length
- B** straight stitch with altered stitch length
- C** straight stitch with altered needle positions

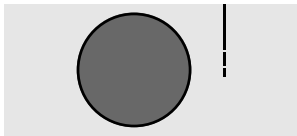

## Alter the stitch length

- the stitch length can be altered while sewing
- turn the external stitch length knob to the right to lengthen
- turn the external stitch length knob to the left to shorten



## Change the needle position

- push the external needle position buttons to change the needle position so stitching can be placed exactly where it is desired
- each push of the button moves the needle one position in the direction of the symbol
- < five positions to the left
- > five positions to the right
- total of 11 positions, including center
- excellent for edgestitching, topstitching, and making tucks

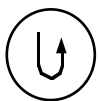

## Securing with Quick Reverse

- press the quick reverse button and the machine sews in reverse
- release the button and the machine sews forward



## TIPS

### Adjust the stitch length to suit the fabric:

- e.g. use a longer stitch length (approximately 3mm – 4mm) with denim, shorter length (2mm–2.5mm) with batiste

### Adjust the stitch length to suit the thread:

- e.g. use a longer stitch length (approximately 3mm – 5mm) when sewing with cordonnet thread for top stitching

### Activate needle stop down

- prevents the fabric slipping when you stop to adjust it

## Securing stitch



Stitch: **Securing stitch No. 5**  
 Needle: **size and type suitable for the fabric selected**  
 Thread: **cotton or polyester**  
 Feed-dog: **up (sewing position)**  
 Presser foot: **Reverse pattern foot No. 1**

### Securing program

- for all fabrics
- secures beginning and end of seam
- reverse stitching is exactly on top of the seam, preventing puckers



### Stitch selection

- touch stitch No. 5
- quick reverse symbol will appear on-screen as a reminder to use it when ending the seam

### Screen

- suggests using reverse pattern presser foot No. 1
- basic settings (length and width) for Straight Stitch are preset at 2.5mm (length) and 0mm (width)

### Beginning the seam

- machine secures the seam automatically (4 stitches forward, 4 stitches reverse)
- machine continues straight stitching

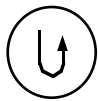

### Ending the seam

- when coming to the end of the seam, press and release the quick reverse button above the needle
- machine will secure the seam automatically (4 stitches forward, 4 stitches reverse)
- machine stops automatically when securing is complete



## TIP

### Seaming

- quick and easy securing at beginning and end of seam

## Edge stitching

Stitch: **Straight Stitch No. 1**  
 Needle: **size and type suitable for the fabric selected**  
 Thread: **cotton, polyester, or cordonnet (topstitching)**  
 Feed-dog: **up (sewing position)**  
 Presser foot: **Reverse pattern foot No. 1 or Blindstitch Foot No. 5 or Edgestitch Foot No. 10 (optional accessory)**

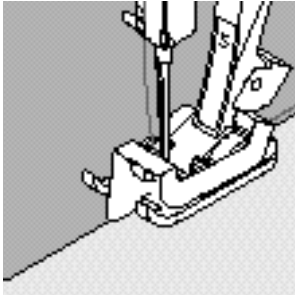

### Narrow edge stitching

#### Needle position

- left for outer edge
- right for inner edge

#### Presser foot

- Blindstitch foot No. 5

#### Outer edge

- place finished or folded edge of fabric against the guide of the foot
- select needle position at desired distance from the edge

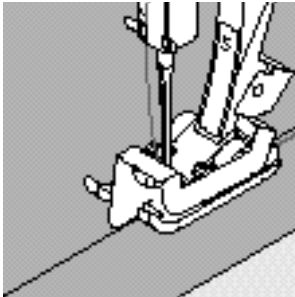

### Hem edges

- place edge of fold (inside upper edge of hem) against the guide on the foot
- select a needle position that places the stitching along the upper edge of the folded hem
  - Foot 5 – use any left or far right needle position
  - Foot 10 – use any left or right needle position

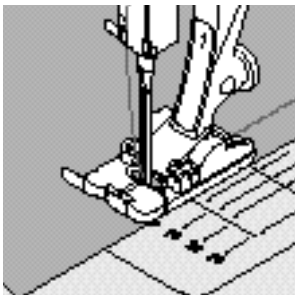

### Wide edge stitching

#### Needle position

- any needle position can be used for this stitching
- different needle positions will place the stitching at various distances from the edge of the fabric

#### Presser foot

- reverse pattern foot No. 1

#### Guiding the fabric

Presser foot as a guide:

- align the edge of the presser foot with the finished or folded edge of the fabric

Stitch plate as a guide:

- guide the folded edge along the markings on the stitch plate for stitching 1cm–3cm from the edge

Quilting/Seam guide as a guide:

- insert the quilting/seam guide bar into the hole on the back of the presser foot shank
- adjust as desired, measuring from the needle
- tighten the screw
- guide the finished or folded edge of the fabric along the quilting/seam guide
- to sew parallel lines, guide the quilting/seam guide bar along a previously sewn line of stitching

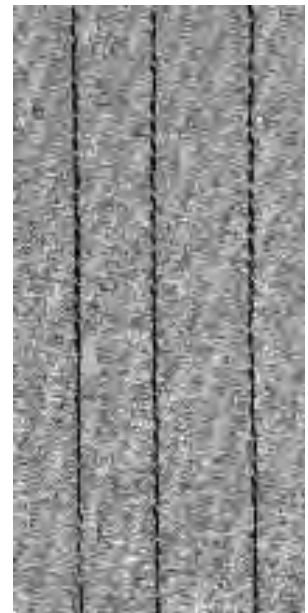
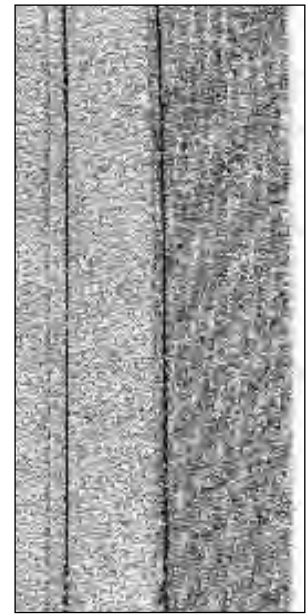
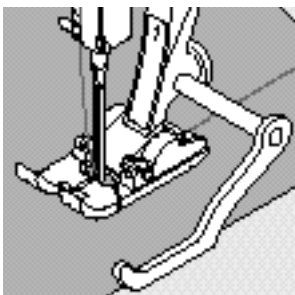

## TIP

### Edge stitching with quilting/seam guide

- eliminates tedious marking when sewing parallel lines or grids

## Zig-zag stitch



Stitch: **Zig-zag No. 2**  
 Needle: **size and type suitable for the fabric selected**  
 Thread: **cotton or polyester**  
 Feed-dog: **up (sewing position)**  
 Presser foot: **Reverse pattern foot No. 1**

### Zig-zag applications

- for all fabric types
- for finishing raw edges
- for decorative work

### Stitch selection

- touch stitch No. 2

### Screen

- suggests using reverse pattern presser foot 1
- basic settings (length and width) for Zigzag Stitch are preset at 1.5mm (length) and 3.5mm (width)
- basic settings as well as altered settings are always visible on the screen

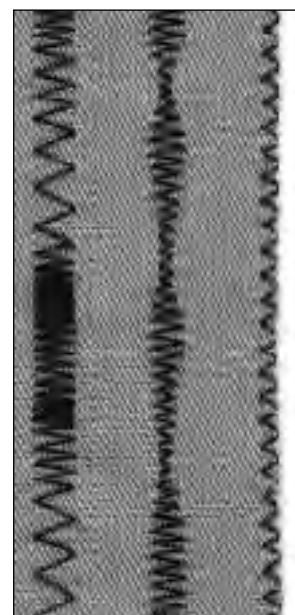

**B**      **A**      **C**

- A** zigzag stitch with altered stitch length
- B** zigzag stitch with altered stitch width
- C** fabric edges finished with zigzag stitch



### Altering the stitch width

- the stitch width can be altered while sewing
- turn the external stitch width knob to the right to make the stitch wider
- turn the external stitch width knob to the left to make the stitch more narrow
- move the knob in a smooth, gentle rotation for a smooth tapering of the stitch

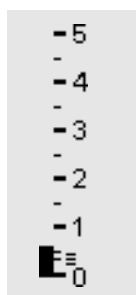

### Alter the stitch length

- the stitch length can be altered while sewing
- turn the external stitch length knob to the right to lengthen
- turn the external stitch length knob to the left to shorten
- move the knob in a smooth, gentle rotation for a smooth transition of the stitch length



### Satin stitch

- short stitch length setting indicated by parallel lines
- filled-in stitch used for applique, cutwork, embroidery, and other decorative applications

### Oversewing edges

- good edge finish for most types of fabric
- guide edge of fabric into the center of the presser foot
- needle goes into fabric on one side and over the edge into the air on the other
- do not select too wide a width or too long a stitch – the edge should lie flat and not roll



## TIPS

### Oversewing edges with Zig-zag

- if edges roll, use the Vari-overlock stitch and foot No. 2

### Embroidery with satin stitch

- experiment with adjusting the stitch width for new decorative effects

## Altered Memory

Stitch:	<b>Any selected stitch</b>
Needle:	<b>size and type suitable for the fabric selected</b>
Thread:	<b>cotton or polyester</b>
Feed-dog:	<b>up (sewing position)</b>
Presser foot:	<b>Reverse pattern foot No. 1</b>

### Altered Memory

- for all stitches and fabrics
- altered stitch length and width settings are saved automatically
- sew a stitch (e.g. zig-zag stitch)
- select and sew a second stitch (e.g. straight stitch)
- when the first stitch (zig-zag), is recalled, all altered settings remain
- particularly useful when alternating between two applications, such as seaming and edge finishing
- the altered memory can hold as many stitches as needed
- the altered memory is lost when the machine is turned off

### Altering the basic settings

- select zig-zag stitch No. 2
- alter stitch width to 5mm
- alter stitch length to 1mm
- sew a line of the altered zigzag stitch
- select running stitch No. 4
- alter stitch width to 5mm
- alter stitch length to 1mm
- sew a line of the altered running stitch

### Altered settings remain active

- select zig-zag stitch No. 2
- altered settings remain active
- sew a line of the altered zigzag stitch
- select running stitch No. 4
- altered settings remain active
- sew a line of the altered running stitch

### Return to basic settings

- Method 1: press the external clr button
- Method 2: alter the stitch width and length manually
- Method 3: turn machine off – altered settings will *not* be saved

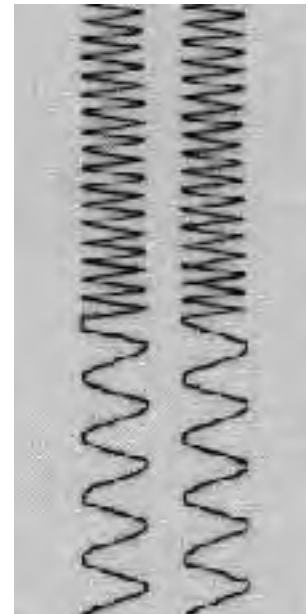

A B

**A** altered zigzag stitch changed to altered running stitch

**B** changed back to altered zigzag stitch and then changed again to altered running stitch



## TIPS

### Altering stitch width and length

- the width and length of all stitches can be adjusted to suit the fabric and type of sewing. Very convenient when sewing a project which may require using the same stitches repeatedly.

### Changing Stitches

- alternating between sewing seams and finishing edges is easy with altered settings for many stitches, which remain altered once set



## Practical stitch seams

### Open seams

Seams which are pressed open

- seam allowance width as wide as desired
- seam lies flat
- seam does not stretch

Suggested stitches:

- straight, narrow zigzag, super stretch, and triple zigzag

Application:

- primarily for woven fabrics
- works for most types of sewing projects, including clothing, home accessories, and crafts

### Closed seam (overlock seams)

Seams which cannot be pressed open

- sewn and finished in one operation
- narrow seam allowances

Suggested stitches:

- vari-overlock, double overlock, and jersey

Application:

- primarily for knits and jerseys
- excellent for knit clothing, lingerie, and bed linens



### Flat joining seams

Seams where the edges are overlapped and then sewn

- stitching is on the seam allowances

Suggested stitch:

- stretch overlock

Application:

- particularly good for terry cloth
- also good for beachwear, leisure wear, and lingerie



## Zig-zag seam



Stitch:	<b>Zig-zag stitch No. 2</b>
Stitch width:	<b>approximately 1mm</b>
Stitch length:	<b>approximately 0.5mm</b>
Needle:	<b>universal, ballpoint, or stretch as needed</b>
Thread:	<b>cotton or polyester</b>
Feed-dog:	<b>up (sewing position)</b>
Presser foot:	<b>Reverse pattern foot No. 1</b>

### Open seam applications

- stitch has more "give" than a straight stitch
- use for knits, outer wear, children's knit clothes
- seam lies flat and is not bulky
- allows a garment to be let out



## TIP

### Prevent stretching

- to prevent the stretching of the seam while being sewn, reduce the presser foot pressure to suit the fabric

## Triple Straight Stitch seam

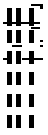

Stitch: **Triple Straight Stitch No. 6**  
 Needle: **80–90 universal or jeans**  
 Thread: **polyester**  
 Feed-dog: **up (sewing position)**  
 Presser foot: **Reverse pattern foot No. 1**

### Open seam

- durable seam for firm and densely woven fabrics such as denim and corduroy
- reinforced seam for garment areas subject to hard wear



### TIP

**For heavy layers or very densely woven fabrics**  
 A Jeans needle and Jeans Foot No. 8 will help when stitching very heavy fabrics, such as denim or canvas

## Stretch/Super stretch seam

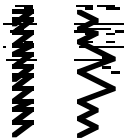

Stitch: **Super stretch No. 11 or Stretch No. 18**  
 Needle: **universal, ballpoint, or stretch as needed**  
 Thread: **cotton or polyester**  
 Feed-dog: **up (sewing position)**  
 Presser foot: **Reverse pattern foot No. 1**

### Open seam

- stretch seam for knit fabrics
- ideal for sports and leisure wear
- seam lies flat and is not bulky



### TIPS

#### Knits and jersey

- use a new needle to prevent damaging the fabric fibers

#### Sewing stretch fabrics

- if necessary use a stretch ball point needle (130/705H-S); needle point slides between the fibers

#### Prevent stretching

- to prevent the stretching of the seam while being sewn, reduce the presser foot pressure to suit the fabric

## Vari-overlock seam



Stitch: **Vari-overlock No. 3**  
 Needle: **size and type suitable for the fabric selected**  
 Thread: **cotton or polyester**  
 Feed-dog: **up (sewing position)**  
 Presser foot: **Overlock foot No. 2**

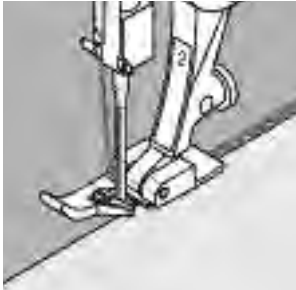

### Closed seam

- stretchy seam in fine, soft knits such as silk jersey and interlock

### Sewing

- guide the raw edge along the pin on the overlock foot
- the stitch will form over the pin and over the edge of the fabric



## TIPS

### Knits and jersey

- use a new needle to prevent damaging the fabric fibers

### Sewing stretch fabrics

- if necessary use a stretch needle (130/705H-S); the point slides easily between the fibers

## Double overlock seam/Jersey overlock seam



Stitch: **Double Overlock No. 10 or Jersey Overlock No. 20**  
 Needle: **size and type suitable for the fabric selected**  
 Thread: **cotton or polyester**  
 Feed-dog: **up (sewing position)**  
 Presser foot: **Overlock foot No. 2**

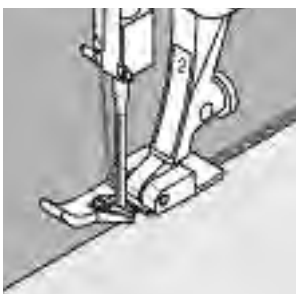

### Closed seam

- overlock seam in loose knits and cross seams in knits and jerseys

### Sewing

- guide the raw edge along the pin on the overlock foot
- the stitch will form over the pin and over the edge of the fabric

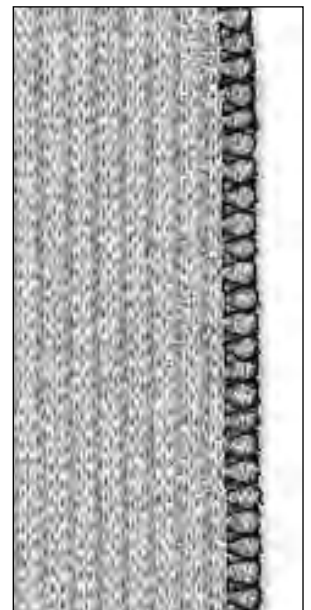

## TIPS

### Knits and jersey

- use a new needle to prevent damaging the fabric fibers

### Sewing stretch fabrics

- if necessary use a stretch ball point needle (130/705H-S); the point slides easily between the fibers

## Stretch overlock seam/Reinforced overlock seam

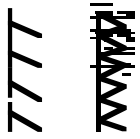

Stitch: **Stretch Overlock No. 13 or Reinforced Overlock No. 19**  
 Needle: **universal, ballpoint, or stretch as needed**  
 Thread: **cotton or polyester**  
 Feed-dog: **up (sewing position)**  
 Presser foot: **Reverse pattern foot No. 1**

### Closed seam

- overlock seam in coarse or loose knits

### Sewing

- sew stretch overlock along the fabric edge
- the stitch should go over the edge of the fabric on the right swing of the needle

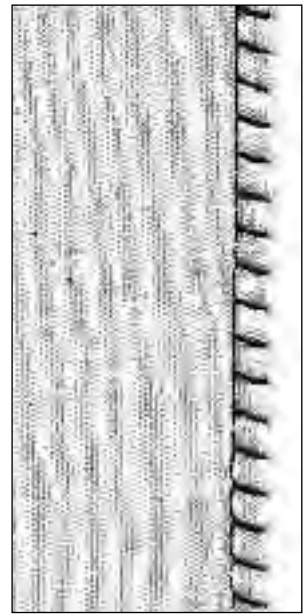

## TIP

### Prevent stretching

- to prevent the stretching of the seam while being sewn, reduce the presser foot pressure to suit the fabric

## Flat joining seam



Stitch: **Stretch Overlock No. 13**  
 Needle: **universal, ballpoint, or stretch as needed**  
 Thread: **cotton or polyester**  
 Feed-dog: **up (sewing position)**  
 Presser foot: **Reverse pattern foot No. 1**

### Flat joining seam

- fabric edges are overlapped and the stitch is placed on the seam allowance
- produces a very flat, durable seam
- ideal for fluffy, thick materials such as terry cloth, felt and leather

### Sewing

- sew stretch overlock along the fabric edge
- the stitch should go over the edge of the top layer of fabric on the right swing of the needle

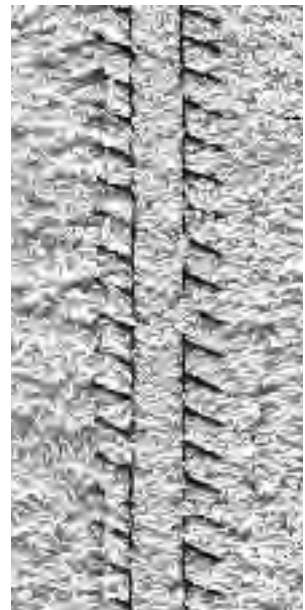

## TIPS

### Fabric and thread

- use a matching thread color, for less visibility in fluffy fabrics

### Thick seam

- particularly suitable for fabrics in which a normal straight stitch seam would stretch open

## Hems with practical stitches

### Preparation

- fold and press hem; baste if desired

### Sewing

- sew hem at desired depth (right side)
- trim excess fabric (wrong side)

## Visible hem with Jersey stitch



Stitch: **Jersey stitch No. 14**  
 Needle: **universal, ballpoint, or stretch as needed**  
 Thread: **cotton or polyester**  
 Feed-dog: **up (sewing position)**  
 Presser foot: **Reverse pattern foot No. 1**

### Visible stretch hem

- for all types of cotton, wool, synthetic and mixed fiber jerseys



### TIPS

#### Knits and jersey

- use a new needle to prevent damaging the loops of the knit fabric

#### Sewing stretch fabrics

- if necessary, use a stretch needle (130/705H-S); the point slides easily between the fibers

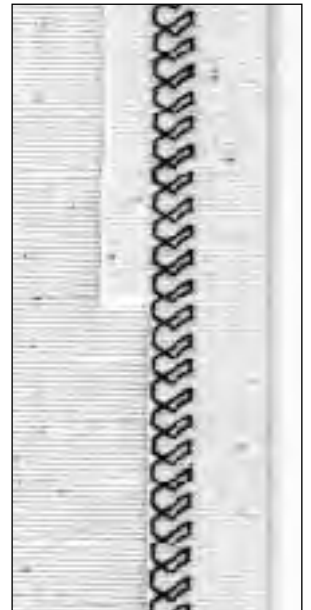

## Visible hem with Triple Zig-zag



Stitch: **Triple Zig-zag No. 7**  
 Stitch width: **2.5 mm – 5 mm depending on fabric**  
 Stitch length: **basic setting**  
 Needle: **universal or jeans**  
 Thread: **cotton or polyester**  
 Feed-dog: **up (sewing position)**  
 Presser foot: **Reverse pattern foot No. 1**

### Strong visible seam

- for firm, densely woven fabrics, particularly good for denim and canvas



### TIPS

#### Hems on fabrics which may ravel

- finish the raw edge of the hem; do not trim them after sewing

#### Sewing firm, hard fabrics

- use a jeans needle for better penetration

## Sewing knits

### Important tips for sewing knit fabrics

#### Start with a new needle

- blunt needles can damage knits

#### Use a stretch needle (130/705 H-S) if necessary

- the needle point slides easily between the fibers

#### Use a fine sewing thread

- coarse threads can damage knits and cause holes when the garment is washed

#### When basting, use a darning thread

- very lightweight (80 weight) darning thread is easier to remove once the seam is complete

#### Sew a test, when necessary

- the elasticity of knit fabrics varies greatly
- adjust basic settings to suit the fabric, the seam should be as stretchy as the fabric
- for greater elasticity:
  - use a shorter stitch length
  - use a wider stitch width
 (only one of these adjustments may be necessary)

#### Presser foot pressure

- soft, loose knits can wave when sewn: reduce the pressure until the seam lies flat the machine must still feed the fabric properly

## Honeycomb stitch edges



Stitch: **Honeycomb stitch No. 8**  
 Needle: **universal, ballpoint, or stretch as needed**  
 Thread: **cotton or polyester**  
 Feed-dog: **up (sewing position)**  
 Presser foot: **Reverse pattern foot No. 1**

### Honeycomb stitch edges

- for all cotton, wool, synthetic and mixed fiber knits

#### Preparation

- turn the raw edge under by 1 cm ( $\frac{3}{8}$ "); press and baste if desired

#### Sewing

- sew from the right side
- trim excess fabric from the wrong side



#### Balance/corrections

- Stitch is too open – make the stitch shorter by touching the "up" (↑) balance arrow several times



- Stitch is overlapping – make the stitch longer by touching the "down" (↓) balance arrow several times

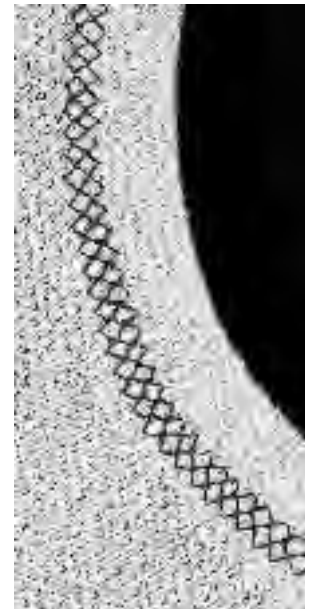

## TIPS

### Needle stop down

- needle stays in fabric when pivoting around curves (neck edges and armholes)

### Presser foot pressure

- reduce pressure if hem stretches

## Ribbing with overlock seam



Stitch: **Vari-overlock No. 3**  
 Needle: **size and type suitable for the fabric selected**  
 Thread: **cotton or polyester**  
 Feed-dog: **up (sewing position)**  
 Presser foot: **Overlock foot No. 2**

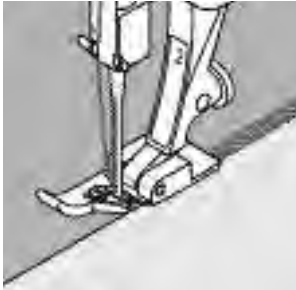

### Ribbing with overlock seam

- for all fine cotton, synthetic and mixed fiber knits

### Preparation

- fold ribbing in half
- pin and baste to opening, front edge to outside

### Sewing

- sew Vari-overlock over the raw edge
- guide the raw edge along the pin of the foot
- the stitch will form over the pin and over the edge of the fabric

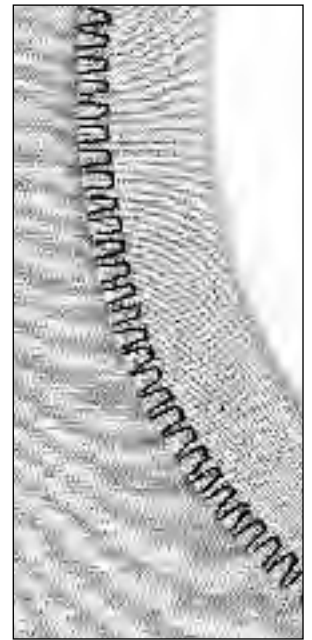

## TIP

### Needle stop down

- needle stays in fabric when you stop to adjust the ribbing on curves (neck edge, armholes)

# Zippers

Stitch: **Straight stitch No. 1**  
 Needle: **size and type suitable for the type of fabric selected**  
 Thread: **cotton or polyester**  
 Feed-dog: **up (sewing position)**  
 Presser foot: **Zipper foot No. 4**  
 Needle position: **far right or far left**

### Preparation:

- baste or pin zipper in place
- fabric edges should meet over the center of the zipper

### Sewing

- sew both sides of zipper from bottom to top
- needle position should be fully to the right on one side and fully to the left on the other
- edge of presser foot runs next to zipper teeth
- position the foot so the needle stitches along the edge of the zipper teeth

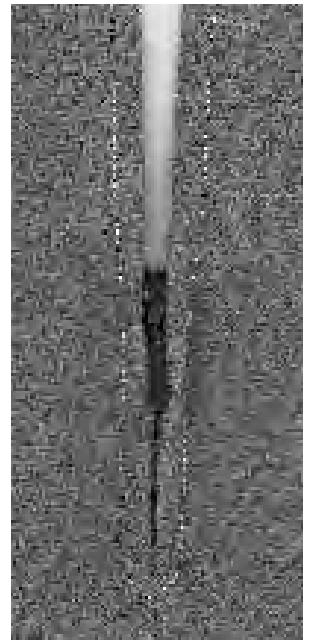
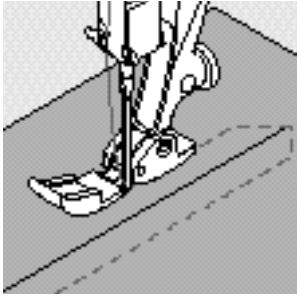

## TIPS

### To sew around the zipper pull

- close the zipper and sew up to about 5 cm (2") away from the pull
- stop with the needle down in the fabric, raise the presser foot. Open the zipper, pulling the tab below the needle; lower the foot and continue to sew

### Starting to sew

- hold the thread firmly when starting to sew
- pull the fabric gently behind the needle for a few stitches

### Dense fabric

- for even stitch formation, use a 90 or 100 needle



## Long stitch function

This function works with the straight stitch to produce a longer than usual stitch.

The machine sews every second stitch when the Long stitch function is activated. The longest stitch possible is 10 mm when the stitch length is set at 5mm.

For decorative top stitching, the Long stitch function can be combined with Triple Straight stitch.



Stitch: **Straight stitch No. 1 or Triple Straight Stitch No. 6**  
 Needle: **size and type suitable for the fabric selected**  
 Thread: **cotton or polyester**  
 Stitch length: **3.5 mm – 5 mm**  
 Feed-dog: **up (sewing position)**  
 Presser foot: **Reverse pattern foot No. 1**  
 Function: **Long stitch**



### Long stitch

- for all work where a longer stitch is desired
- for topstitching



## TIPS

### Decorative top stitching

- use cordonnet (topstitching) thread and a 100-110 needle with the straight stitch

### Basting

- long stitch can also be used to baste fine fabrics

## Basting stitch

This feature is a stitch rather than a function (such as the long stitch). When this stitch (No. 21) is selected, the machine stitches a straight stitch, sewing every fourth one. The longest stitch possible is 20 mm when the stitch length is set at 5 mm.

Stitch: **Basting stitch No. 21**  
 Needle: **size and type suitable for the fabric selected**  
 Thread: **cotton or polyester**  
 Stitch length: **3.5 mm – 5 mm**  
 Feed-dog: **up (sewing position)**  
 Presser foot: **Reverse pattern foot No. 1**

### Basting stitch

- for all work where a very long stitch is desired
- quick and easy basting of seams, hems, etc.
- easy to remove

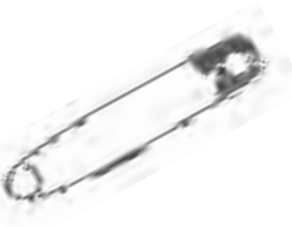

## TIPS

### Securing a basted seam

- to secure basting stitches, sew a few normal length straight stitches at the beginning and end of the seam

### Basting

- use a fine darning thread; it is easier to remove after the seam has been sewn

## Blind hem



Stitch: **Blindstitch No. 9**  
 Needle: **size and type suitable for the fabric selected**  
 Thread: **cotton, polyester, or silk**  
 Feed-dog: **up (sewing position)**  
 Presser foot: **Blindstitch foot No. 5**

### Blind hem

- for invisible hems in medium to heavy cotton, wool and mixed fiber fabrics

### Preparation

- finish the raw edges as desired
- fold the hem and baste or pin in place
- fold the garment back over the right side of the fabric to expose the finished lower edge
- place the work under the presser foot (see drawing) with the guide positioned against the folded back fabric

### Sewing

- the needle should just pierce the edge of the fold
- adjust the stitch width to suit the fabric
- after sewing about 10 cm (4"), check both sides of fabric and adjust the stitch width if necessary

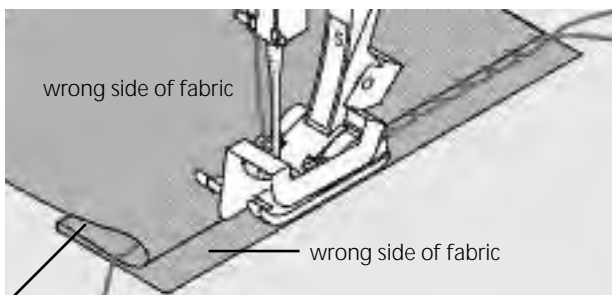
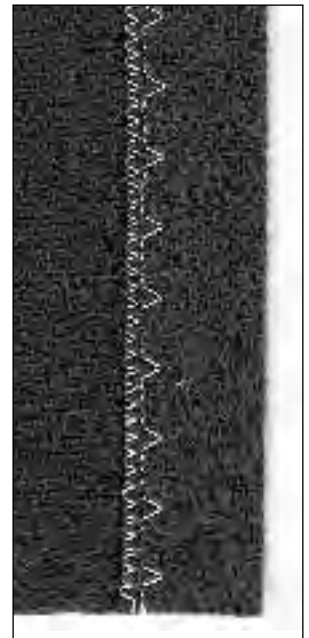

right side of fabric



## TIP

### Fine stitch width adjustment

- guide the raw edge along the guide on the foot to keep the stitch depth even

## Sewing on narrow elastic with Universal stitch



Stitch: **Universal stitch No. 15**  
 Stitch width: **depends on width of elastic**  
 Needle: **type and size to suit the fabric selected**  
 Thread: **cotton or polyester**  
 Feed-dog: **up (sewing position)**  
 Presser foot: **Reverse pattern foot No. 1**  
**or Embroidery foot No. 6 (optional accessory)**

### Sewing on elastic

- for gathering long lengths of fabric, frills and flounces in fine fabrics
- works well for gathered sleeve edges and neck openings

### Preparation

- cut elastic to length required

### Sewing

- oversew the elastic, adjusting the stitch width to be slightly wider than the elastic
- needle must not pierce the elastic
- after sewing, adjust the gathers evenly



## TIPS

### Secure the beginning and end of elastic

- sew a few straight stitches backward and forward to secure the elastic

### Quick hem finish

- for children's or doll clothing
- sew sleeve edges with elastic before sewing seams

## Sewing on shirring elastic/cord with Gathering stitch



Stitch: **Gathering stitch No. 12**  
 Needle: **size and type to suit the fabric selected**  
 Thread: **cotton or polyester**  
 Feed-dog: **up (sewing position)**  
 Presser foot: **Buttonhole foot No. 3**

### Shirring elastic/cord

- for gathering long lengths of fabric

### Preparation

- cut shirring elastic or cord double the length of the edge
- fold in half lengthways
- hook over the center toe on the buttonhole foot
- take both ends of the cord under the foot to the back

### Sewing

- sew a few stitches
- lift the elastic or cord at the front and pull towards you
- leave ends behind the presser foot
- oversew cord without stitching into it
- after sewing, pull the cord to gather the fabric
- stretch elastic while sewing; the more it is stretched, the tighter the gathers

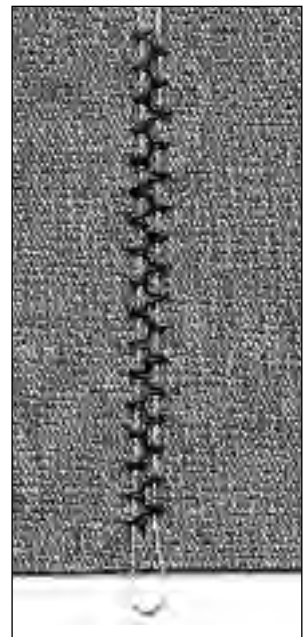

## TIPS

### Securing beginning and end

- sew a few stitches with the feed-dog lowered

### Presser foot pressure

- increase the foot pressure, if necessary, for better feeding of the fabric and cord

## Sewing on wide elastic



- Stitch: **Running stitch No. 4 or Sewn-out Zig-zag No. 16 or Lycra stitch No. 17**  
 Stitch length: **adjust to suit elastic**  
 Needle: **size and type to suit the fabric selected**  
 Thread: **cotton or polyester**  
 Feed-dog: **up (sewing position)**  
 Presser foot: **Reverse pattern foot No. 1**

### Wide elastic

- for edges on sportswear and lingerie

### Preparation

- cut elastic to length required
- divide fabric edge and elastic into 4 equal sections and mark
- pin elastic to raw edge, matching markings

### Sewing

- stretch the elastic to fit the raw edge while sewing
- trim excess fabric close to the stitching

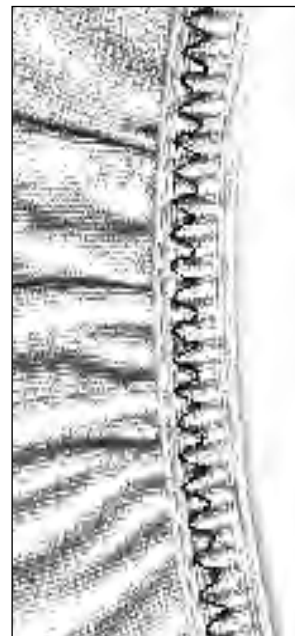

## TIP

### Preventing elastic from stretching too much

- avoid over-stretching the elastic; adjust the presser foot pressure to suit the fabric.

## Bartack program



Stitch: **Bartack program No. 24 or Buttonhole bartack No. 25**  
 Needle: **size and type to suit the fabric selected**  
 Thread: **cotton, polyester, or rayon**  
 Feed-dog: **up (sewing position)**  
 Presser foot: **Reverse pattern foot No. 1**

### **Bartack program**

- for reinforcing seams subject to heavy wear such as those on pockets, jackets, jeans, and overalls
- use for attaching ribbons to a quilt for tying

### **Buttonhole bartack**

- for reinforcing buttonhole bartacks

### **Sewing**

- the machine starts top left with the bartack program
- the machine stops automatically at the end of the program

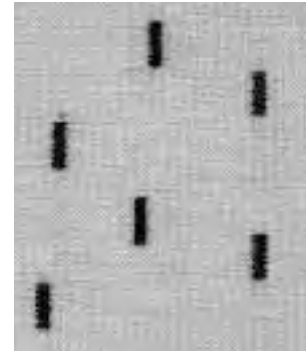

## **TIP**

### **Decorative bar tacks**

- increase the stitch length and sew the bar tack program with decorative thread as a decorative element; combine with other stitches

## Important information on buttonholes



### Thread tension

- thread the finger of the bobbin case
- the bobbin tension will be slightly tighter than normal
- this gives a slightly rounded appearance to the beads, making the buttonhole more attractive

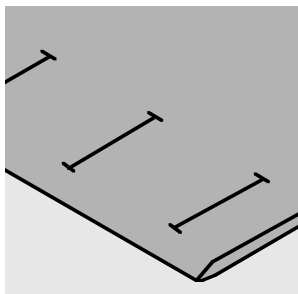

### Manual buttonholes

- stitched using Buttonhole foot 3
- the buttonhole length of manually stitched buttonholes must be marked on the fabric in the appropriate position

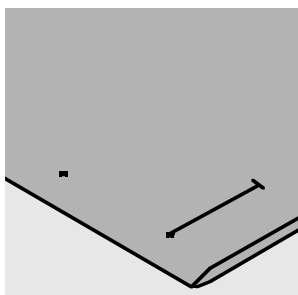

### Automatic buttonholes

- stitched using Automatic buttonhole foot 3A
- mark the length of the first buttonhole
- after sewing the first buttonhole, the length for all subsequent buttonholes is automatically programmed
- mark the starting point of all subsequent buttonholes
- Buttonhole length = buttonhole opening in mm

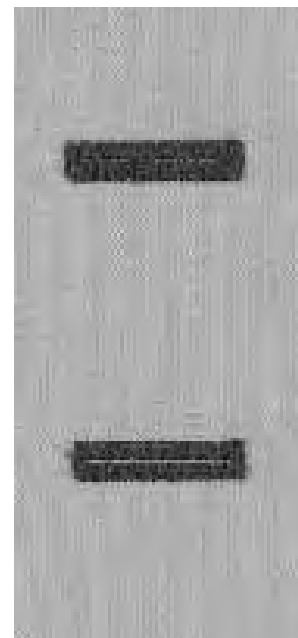

### Test sewing

- always sew a test on the fabric(s) you will use with the same interlining, interfacing, and stabilizers
- select the same buttonhole type
- sew the buttonhole in the same direction on the fabric (with or against the grain)

### Corrections

- To adjust the bead width:
- alter the stitch width

### Altering the stitch length:

- any alterations to the stitch length affect both beads (making them more or less dense)
- *always stitch a new sample to reprogram the buttonhole after any changes are made to the stitch length*

### Balance for automatic/manual buttonholes

- any balance alterations affect both beads

### Balance for stitch counter buttonholes

- any balance alterations affect the *first* (left) bead:
  - *Bead too dense*– if the first bead looks like A, use the "down" arrow to correct it
  - *Bead not dense enough* – if the first bead looks like B, use the "up" arrow to correct it
- *always stitch a new sample to reprogram the buttonhole after any changes are made to the balance*



A



B

### Clear balance

- press the external clr button

**Corded Buttonhole**

- gimp cord reinforces buttonholes and enhances their appearance
- the loop of the cord should be at the end of the buttonhole most subject to wear or where the button is sewn on
- position the work accordingly
- gimp cord is particularly recommended for standard and stretch buttonholes

**Suitable cords:**

- Perle yarn No. 8
- strong hand sewing thread
- fine crochet yarn
- gimp cord

**Hooking the cord onto presser foot No. 3**

- insert the needle at the beginning of the buttonhole
- raise the presser foot
- hook the cord over the center toe of the foot

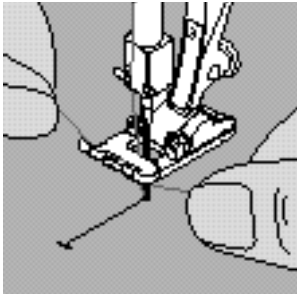

- place both ends of the cord in the grooves on the sole of the foot and pull them to the back
- lower the presser foot

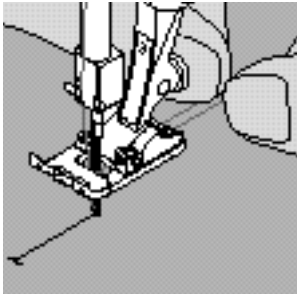
**Sewing**

- sew the buttonhole in the usual manner
- do not hold the cord tightly
- the buttonhole will form over the cord, covering it

**Securing the cord**

- pull the cord through the buttonhole until the loop disappears into the end of it
- pull the ends of the cord through to back of the fabric
- knot or secure with stitches

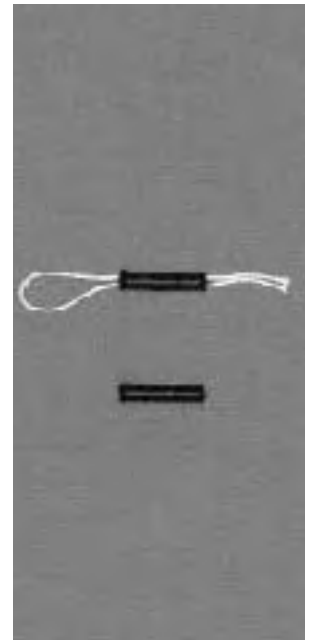
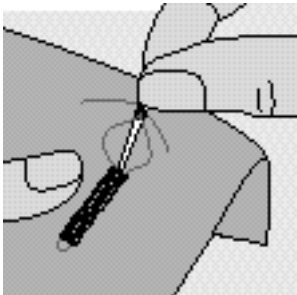



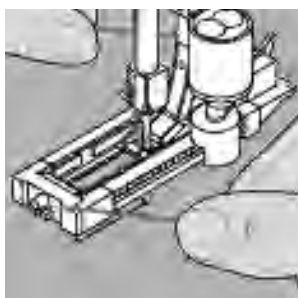

#### Hooking the cord in the automatic buttonhole foot No. 3A

- insert the needle at the beginning of the buttonhole
- raise the presser foot
- guide the cord under the foot to the right
- hook the cord over the pin at the back of the foot

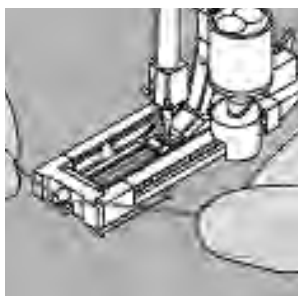

- bring the cords to the front of the foot
- pull each end into one of the notches at the front of the foot

#### Sewing

- sew the buttonhole in the usual manner
- do not hold the cord
- the buttonhole will form over the cord, covering it

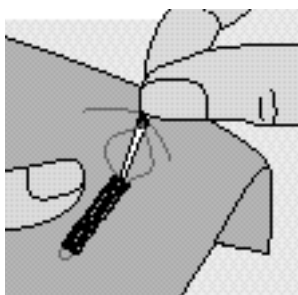

#### Securing the cord

- pull the cord through the buttonhole until the loop disappears into the end of it
- pull the ends of the cord through to back of the fabric
- knot or secure with stitches

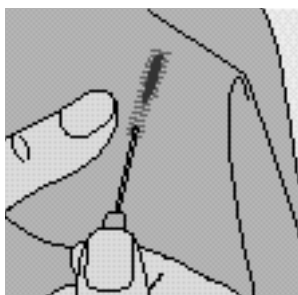

#### Cutting buttonholes open

- using the seam ripper, cut from the ends towards the middle

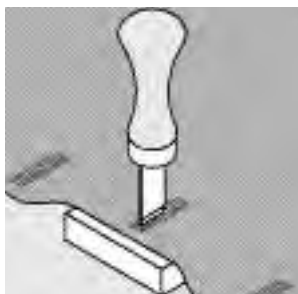

#### Buttonhole cutter and block (special accessory)

- place the fabric on a piece of wood
- place the cutter in the center of the buttonhole
- press the handle of the cutter to open the buttonhole

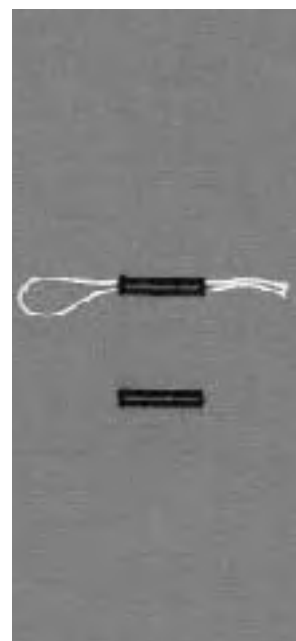

## Straight stitch buttonholes

Straight stitch buttonholes are useful as a foundation for satin stitched buttonholes on soft and loosely woven fabrics that fray easily. The buttonhole beads and bartacks of the second (satin stitched) buttonhole will cover the straight stitching.

They are also good for stitching bound buttonholes and reinforcing buttonhole openings on leather, vinyl, and felt.



Stitch: **Straight stitch buttonholes No. 59**  
 Needle: **size and type suitable for the fabric selected**  
 Thread: **cotton or polyester**  
 Feed-dog: **up (sewing position)**  
 Presser foot: **Buttonhole foot No. 3 or Automatic Buttonhole Foot No. 3A**

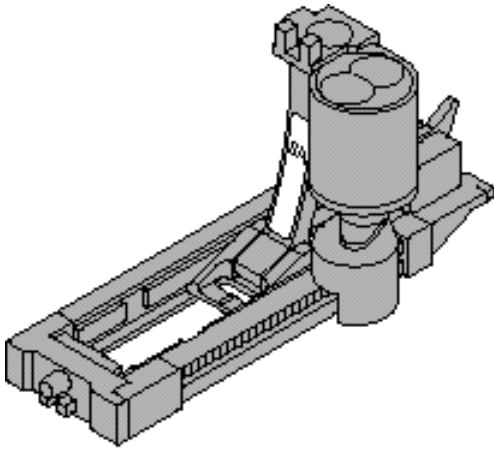

**Program with Automatic buttonhole foot No. 3A**  
 With automatic buttonhole foot No. 3A, the sensor on the foot will automatically register the length of the buttonhole so it can be duplicated

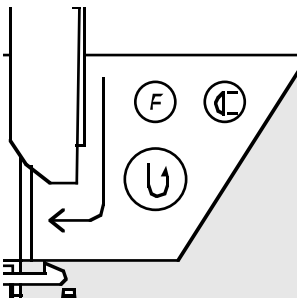
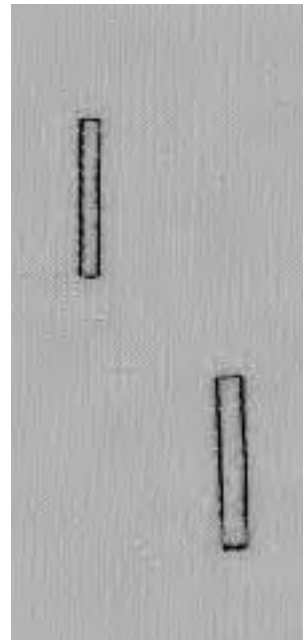

### Sewing the automatic buttonhole program

- sew the first line of straight stitches forward until the desired length is reached
- press and release the quick reverse button
- auto appears = length is programmed
- machine completes the buttonhole program automatically
- all subsequent buttonholes will be stitched to the same length (without pressing the quick reverse button)
- the distance between the stitched lines can be adjusted with the stitch width

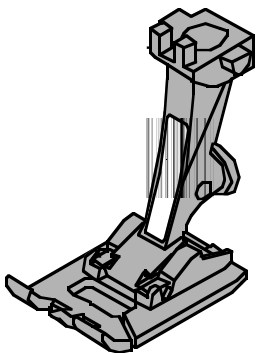

### Stitch counter program with buttonhole foot No. 3

- select function presser foot 3 for stitch counter buttonholes
- Buttonhole foot No.3 will register the number of stitches in the buttonhole

### Sewing the stitch counter buttonhole program

- sew the first bead, stop stitching at the desired length
- press and release the quick reverse button
- continue sewing; the machine will stitch the end of the buttonhole and then the second bead in reverse
- stop stitching when the needle reaches the first stitch
- press and release the quick reverse button
- machine sews the horizontal bar and securing stitches
- machine stops automatically
- auto appears on the screen
- each subsequent stitched buttonhole will be sewn to the same length as the programmed buttonhole

## Automatic buttonholes (all types)

Both beads are sewn in the same direction  
Buttonhole length = buttonhole opening in mm

Stretch buttonholes are particularly effective on all knit fabrics because the double overlock stitch used for the beads stretch with the fabric while keeping its shape.

Note: The automatic buttonhole foot No. 3A must lie perfectly flat on the fabric. If the foot lies on a seam, the length cannot be measured accurately.

Stitch: **Buttonhole (all types)**  
Needle: **size and type suitable for the fabric selected**  
Thread: **cotton or polyester**  
Feed-dog: **up (sewing position)**  
Presser foot: **Automatic buttonhole foot No. 3A**

### Automatic buttonhole

- the lens on automatic buttonhole foot No.3A automatically registers the length of the buttonhole for exact duplication
- buttonholes from 4 – 29 mm can be sewn

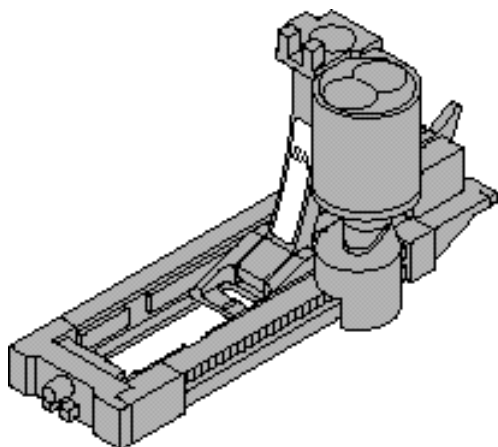

ad  
equence is displayed on the screen (to  
e presser foot symbol)

- sew the first bead forward, stopping at the desired length

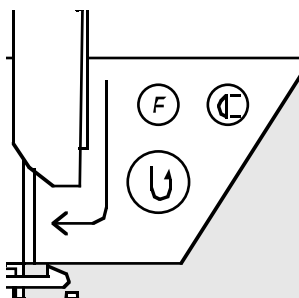

### Program the buttonhole

- press and release the quick reverse button
- auto appears on the screen to indicate that the buttonhole length is programmed
- continue sewing; the machine completes the buttonhole and stops automatically

### Auto buttonhole

- machine stops in position to begin the next buttonhole
- reposition the fabric and sew; all subsequent buttonholes will be sewn automatically to the same length (without pressing the quick reverse button)

### Important:

- if you make a mistake, press the Pattern Begin function
- the machine reverts to the beginning of the buttonhole



## TIPS

### Exact duplicates

- the auto function ensures that each buttonhole will be exactly the same length as the previous one

### Marking

- mark only the beginning of the buttonholes – a real time saver!

### Sewing speed

- sew at moderate speed for best results
- sew all buttonholes at the same speed for a consistent bead density

## Automatic round and keyhole buttonholes

Both beads are sewn in the same direction.  
Buttonhole length = buttonhole opening in mm



Stitch: **Round buttonholes Nos. 54–55  
and keyhole buttonholes Nos. 56–58**  
Needle: **size and type suitable for the fabric selected**  
Thread: **cotton or polyester**  
Feed-dog: **up (sewing position)**  
Presser foot: **Automatic buttonhole foot No. 3A**

### Automatic buttonhole

- the lens on automatic buttonhole foot No.3A automatically registers the length of the buttonhole for exact duplication
- buttonholes from 4–29 mm can be sewn

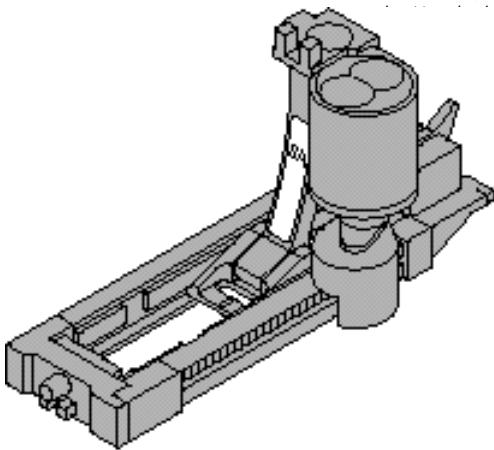

### Buttonhole

- the buttonhole length sequence is displayed on the screen (to confirm the length of the presser foot symbol)
- the machine stitches forward, stopping at the desired

length

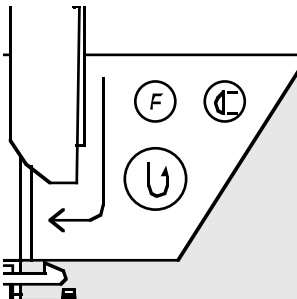

### Program the buttonhole

- press and release the quick reverse button
- auto appears on the screen to indicate that the buttonhole length is programmed
- continue sewing; the machine completes the buttonhole and stops automatically

### Auto buttonhole

- machine stops in position to begin the next buttonhole
- reposition the fabric and sew; all subsequent buttonholes will be sewn automatically to the same length (without pressing the quick reverse button)

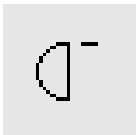

### Important:

- if you make a mistake, press the Pattern Begin function
- the machine reverts to the beginning of the buttonhole

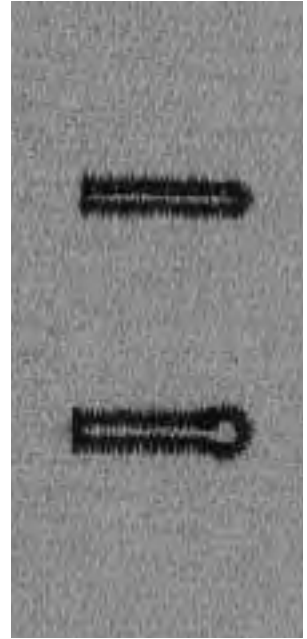

## TIPS

### Exact Duplicates

- the auto function ensures that each buttonhole will be exactly the same length as the previous one

### Marking

- mark only the beginning of the buttonholes – a real time saver!

### Double sewn keyhole buttonholes

- keyhole buttonholes can be sewn twice on thick fabrics
- after sewing the first buttonhole, do not move the work
- simply tap the foot control once to begin sewing again

## Stitch counter buttonholes for all buttonhole types (can not be saved in memory)

- The first (left) bead is sewn forwards, the second (right) bead is sewn in reverse.
- Stitch: **Buttonholes (all types)**  
 Needle: **size and type suitable for the fabric selected**  
 Thread: **cotton or polyester**  
 Feed-dog: **up (sewing position)**  
 Presser foot: **Buttonhole foot No. 3**



### Stitch counter buttonholes

- Select the stitch counter buttonhole function

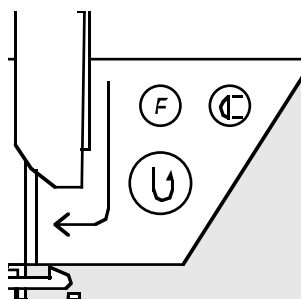

### Length of first bead

- sew the first bead, stopping at the desired length
- press and release the quick reverse button

### Bartack, second bead

- bottom bartack and second bead are sewn in reverse
- stop machine at the first stitch
- press and release the quick reverse button

### Bartack, securing stitches

- machine sews the top bartack and securing stitches
- machine stops automatically
- auto appears on the screen
- the buttonhole is programmed and saved
- each subsequent buttonhole will be sewn identically

### Corrections

- reprogram the buttonhole if any alterations to the stitch width, length, or balance have been made

### Programmed buttonhole on a different fabric

- different fabrics and interfacings can affect the look of a stitch counter buttonhole
- if you are using a new material, program the buttonhole again



## TIPS

### More buttonholes with presser foot No. 3

- ideal for buttonholes which are difficult to sew with the larger foot of Automatic buttonhole foot No. 3A

### Beautiful buttonholes

- keep the speed consistent for beads of equal density
- sew at a moderate speed for best results

### Marking

- mark only the beginning of the buttonholes – a real time saver!

## Manual 4/6-step buttonholes (all types)

Sewing buttonholes manually is ideal if you only need to sew one; also for repairing existing buttonholes.

The number of steps depends on the type of buttonhole. A manually sewn buttonhole cannot be saved.

Stitch: **any buttonhole**  
 Needle: **size and type suitable for the fabric selected**  
 Thread: **cotton or polyester**  
 Feed-dog: **up (sewing position)**  
 Presser foot: **Buttonhole foot No. 3**



### Open the program

- select the type of buttonhole desired (stitches 51–59)
- select the manual buttonhole function from the toolbar

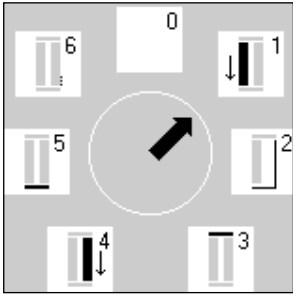

### Step symbols

- the step sequence is shown on the screen:
  - standard buttonhole has 6 steps
  - round buttonhole has 4 steps
  - keyhole buttonhole has 4 steps
- the arrow in the circle is on "0" when the buttonhole is first selected

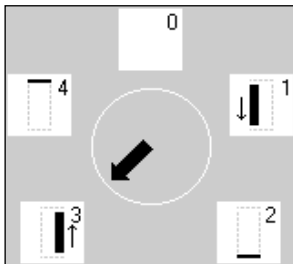

### Sewing a 4 or 6 step buttonhole

- touch 1 on the screen and sew the first bead
- stop the machine at the desired length
- touch 2, sew
- continue in this manner until the buttonhole is complete

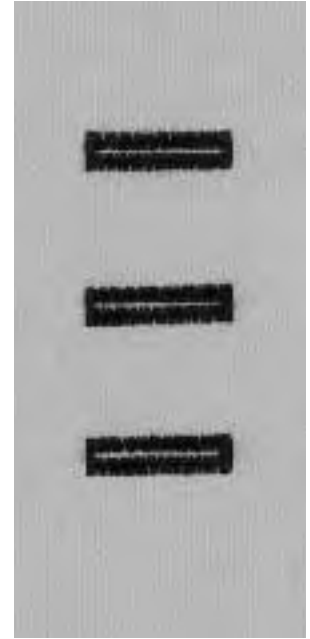

## TIP

### Repairing buttonholes

- use the steps which are necessary to repair the worn sections, omitting or bypassing the unneeded ones

## Button sewing-on program



Stitch: **Button sew-on program No. 60**  
 Stitch width: **depends on the distance between the holes**  
 Needle: **size and type suitable for the fabric selected**  
 Thread: **cotton or polyester**  
 Feed-dog: **down (darning position)**  
 Presser foot: **Button sew-on foot No. 18 (optional accessory)**

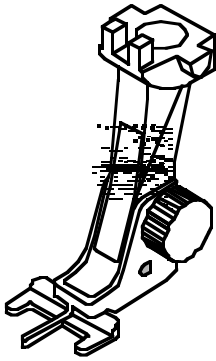

### Button sew-on program

- sews buttons with 2 and 4 holes
- the shank (thread length between button and fabric) can be made shorter or longer as required
- buttons being sewn on for decorative purposes only can be stitched without forming a thread shank



### 2-hole button

- select Button Sew-on program
- check distances between holes with the handwheel
- adjust stitch width if necessary
- hold the threads when starting to sew
- sew; machine stops automatically when program is completed
- machine is automatically ready for the next button

### Beginning and ending threads

- the threads are secured and can be trimmed

### For secure results:

- cut the upper thread close to the button
- pull both bobbin threads until the upper thread is visible on the wrong side
- trim bobbin thread (knot if desired)

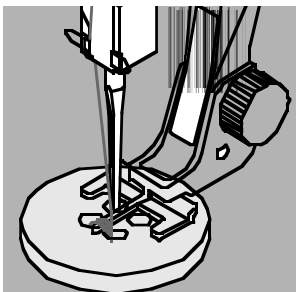

### 4-hole button

- sew the front holes
- carefully move the button forward
- sew the back holes



## TIPS

### Sewing on buttons by machine

- a real time saver, especially when several of the same type buttons must be sewn on, e.g. shirts, blouses, etc.

### Shortening zippers

- a zipper which is too long can be secured simply and quickly using the button sew-on program

## Zigzag Eyelets



Stitch: **Zig-zag Eyelet No. 61**  
 Needle: **size and type suitable for the fabric selected**  
 Thread: **cotton, polyester, or rayon**  
 Feed-dog: **up (sewing position)**  
 Presser foot: **Reverse pattern foot No. 1**

### Zig-zag Eyelet

- ideal opening for cords and narrow ribbons
- attractive decorative elements for clothing, crafts, etc.
- *cannot* be programmed into memory

### Sewing eyelets

- select eyelet stitch No. 61
- position fabric under the presser foot and sew
- machine stops automatically when finished
- machine is automatically ready for the next eyelet

### Punching eyelets

- use an awl or punch to cut open the eyelet

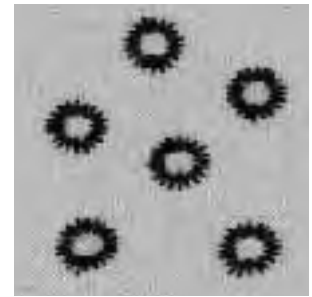

## Straight Stitch Eyelets



Stitch: **Straight Stitch Eyelets No. 62**  
 Needle: **size and type suitable for the fabric selected**  
 Thread: **cotton, polyester, or rayon**  
 Feed-dog: **up (sewing position)**  
 Presser foot: **Reverse pattern foot No. 1**

### Straight Stitch Eyelet

- ideal opening for cords and narrow ribbons
- attractive decorative elements for clothing, crafts, etc.
- *cannot* be programmed into memory

### Sewing eyelets

- select eyelet stitch No. 62
- position fabric under the presser foot and sew
- machine stops automatically when finished
- machine is automatically ready for the next eyelet

### Punching eyelets

- use an awl or punch to cut open the eyelet

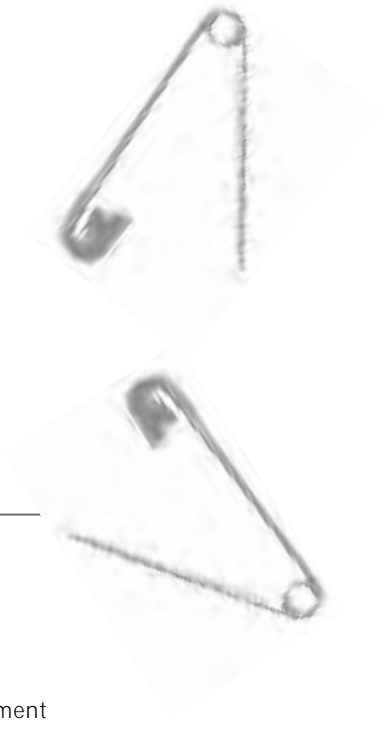
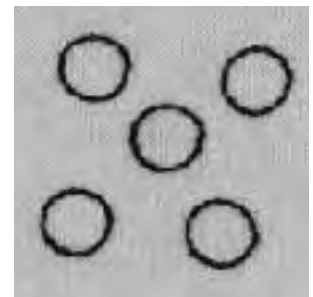

## TIPS

### Eyelets

- ideal for eyes on soft toys, dolls and puppets

### Decorative eyelets

- use decorative thread to introduce an attractive element when combined with other embroidery or decorative stitches



## Elastic Edges



Stitch: **Zig-zag stitch No. 2**  
 Stitch width: **approximately 5mm**  
 Stitch length: **1 mm – 1.5 mm**  
 Needle: **size and type suitable for the fabric selected**  
 Thread: **cotton or polyester**  
 Feed-dog: **up (sewing position)**  
 Presser foot: **Reverse pattern foot No. 1**

### Elastic edges

- use on knit garments to re-form out-of-shape edges

### Sewing

- guide double length of shirring elastic along the edge of the fabric, stretching the elastic slightly
- oversew the elastic with a zig-zag stitch
- do not sew through the elastic, only over it
- adjust elastic after sewing is complete to regain the correct shape and size

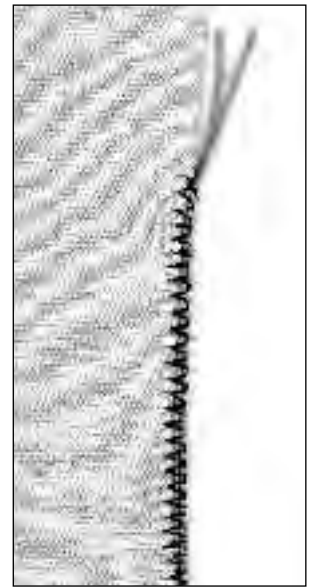

## TIP

### Prevent fabrics stretching

- To prevent the fabric from stretching as it is sewn, reduce the presser foot pressure to suit the fabric

## Reinforced edges on woven fabrics

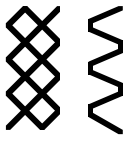

Stitch: **Honeycomb stitch No. 8 or Running stitch No. 4**  
 Needle: **size and type suitable for the fabric selected**  
 Thread: **lightweight darning thread**  
 Feed-dog: **up (sewing position)**  
 Presser foot: **Reverse pattern foot No. 1**

### Reinforcing edges

- good for work clothes, table linen, towels, etc.
- use a cord to match the color of the fabric

### Suitable cords

- perle yarn
- fine crochet yarn
- strong hand-sewing thread
- gimp

### Sewing

- oversee edges with Honeycomb or Running stitch
- oversee a cord along the edge for added reinforcement
- if necessary, sew a second row somewhat in from the edge

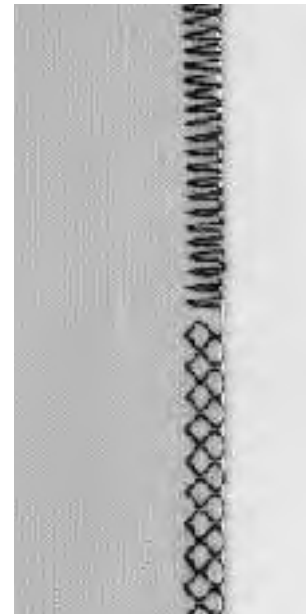

## Patches on knits and jersey



Stitch: **Jersey stitch No. 14**  
 Needle: **size and type suitable for the fabric selected**  
 Thread: **lightweight darning thread**  
 Feed-dog: **up (sewing position)**  
 Presser foot: **Reverse pattern foot No. 1**

### Covering worn or damaged areas

- particularly suitable for stretchy fabrics, lingerie

### Preparation

- do not cut damaged area
- round off the edges of the patch to retain flexibility
- pin and baste to right side

### Sewing

- place patch over worn area
- sew over edge
- sew a second row inside the first if desired
- cut away damaged area

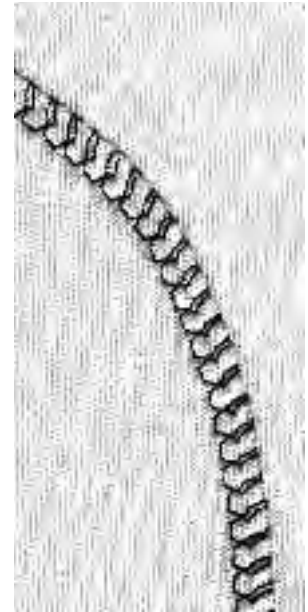

## TIPS

### Knits

- use a new needle to prevent damage of the fabric loops

### Sewing stretch fabrics

- if necessary use a stretch needle (130/705 H-S); point slides easily between the fibers

### Prevent stretching

- to prevent the stretching of the seam while being sewn, reduce the presser foot pressure to suit the fabric

## Automatic darning

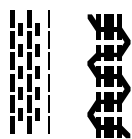

- Stitch: **Simple Darning Program No. 22 or Reinforced Darning Program No. 23**
- Needle: **size and type suitable for the fabric selected**
- Thread: **lightweight darning thread**
- Feed-dog: **up (sewing position)**
- Presser foot: **Automatic buttonhole foot No. 3A**  
**Reverse pattern foot No. 1**

### Preparation

- stretch fine fabrics into a darning or embroidery ring to prevent distortion

### Simple Darning Program No. 22

- replaces threads along the lengthwise grain in all fabrics
- use with Reverse pattern foot No.1
- touch foot 3 on the toolbar across the lower part of the screen
- sew the first row
- press and release the quick reverse button at the desired length; this programs the first length
- sew the second row
- press and release the quick reverse button; this programs the second length
- continue sewing; the machine stops automatically



### Reinforced Darning Program No. 23

- replaces threads along the lengthwise and crosswise grains in all fabrics
- use with Automatic buttonhole foot No. 3A
- insert the needle in the top left of the worn area
- sew the first vertical row
- press and release the quick reverse button at the desired length; this programs the length needed
- continue sewing; the machine stops automatically when finished



### Large areas

- reposition the work under the foot to continue covering the worn area
- begin sewing; the program will repeat (length is saved)

### Corrections

- if the darning becomes distorted, correct with the Balance function (see page 44)



## TIPS

### Reinforced darning

- place a piece of gauze under the worn area before darning

### Large areas

- increase the darning area lengthwise and crosswise by moving the work under the foot

# Manual darning

Stitch: **Straight stitch No. 1**  
 Needle: **size and type suitable for the fabric selected**  
 Thread: **lightweight darning thread**  
 Feed-dog: **down (darning position)**  
 Presser foot: **Darning foot No. 9 (optional accessory)**

## Darning holes or worn areas

- replaces threads with the lengthwise and the crosswise grains in all fabrics

## Preparation

- stretch fabric into darning ring (optional accessory) to prevent distortion
- use of the slide-on sewing table is recommended

## Sewing

- move the darning ring smoothly and without using pressure
- work from left to right

## Stitch over the hole

- sew the first rows to cover the hole (not too close)
- turn work by a quarter turn – 90°

## Cover the first rows

- sew over the first rows – not too close for a soft finish
- turn work by a half turn – 180°

## Complete darning

- loosely and in same direction as 2nd rows

## Method for tubular items

- first step in a horizontal direction
- second and third steps in lengthways direction

## When you have mastered the technique

- work the rows in irregular lengths so that the turns are “lost” in the fabric

## Stitching hints

- move the hoop as if writing the letters “L” or “M”
- when changing direction, move in curves, avoiding points
- this prevents holes and thread breakage
- do not sew in circles; these do not mimic the fabric threads

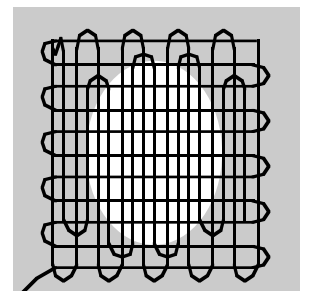
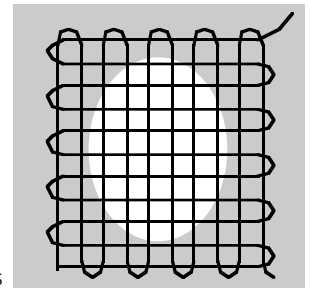
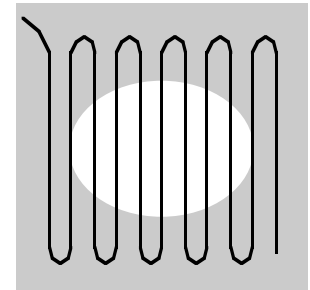
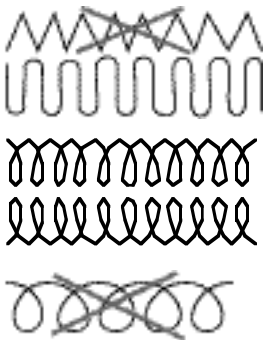

## TIPS

### Thread breaks

- if thread breakage is a problem, it could be that the ring is not being moved smoothly

### Poor stitch formation

- if the thread is lying on top of the fabric, the ring is being moved too quickly
- if there are knots on the underside of the fabric, the ring is being moved too slowly

## Decorative stitches

- Stitch: **Any decorative stitch**  
 Needle: **embroidery needle in a size suitable for the fabric selected**  
 Thread: **cotton or rayon embroidery up (sewing position)**  
 Feed-dog: **Reverse Pattern foot No. 1 or Open Embroidery Foot No. 20 or Embroidery foot No. 6 (optional)**  
 Presser foot:

### Decorative stitches

- for all fabrics
- for embellishing and decorative work

### Stitch selection

- press the external menu button for Decorative stitches
- select the desired stitch group from the screen (groups 100, 300, 400, 600, 700, and 900 are 5mm stitches)
- select the desired stitch

### Screen

- selected stitch is highlighted
- suggests foot No.1; use foot No. 6 or No. 20 for heavy, compact stitches
- basic settings (length and width) are automatically set, but can be altered



### Altering the stitch width

- alter the look of the stitch by adjusting the width
- turn the external stitch width knob to the right to widen the stitch
- turn the external stitch width knob to the left to narrow the stitch
- both the basic settings and the altered settings will be visible on the screen

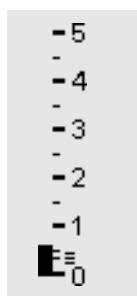

### Altering the stitch length

- alter the look of the stitch by adjusting the length
- turn the external stitch width knob to the right to lengthen the stitch
- turn the external stitch width knob to the left to shorten the stitch
- both the basic settings and the altered settings will be visible on the screen

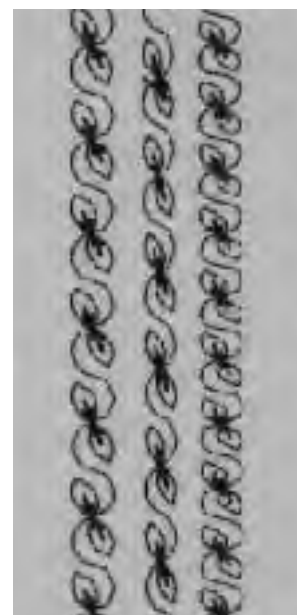

A B C

- A** decorative stitch with preset width and length
- B** decorative stitch with reduced width
- C** decorative stitch with shortened length



## TIP

### Altering the basic settings

- the stitch can be adjusted as desired
- adjust the size of the stitch to suit the size of the item being sewn, e.g. reduce the width for small items such as doll clothes

## Cross stitches

Stitch: **Cross stitches Nos. 301–309, 314 or Cross stitch No. 310**  
 Needle: **size and type suitable for the fabric selected**  
 Thread: **cotton or rayon embroidery**  
 Feed-dog: **up (sewing position)**  
 Presser foot: **Reverse pattern foot No. 1 or Embroidery Foot No. 20**

### Cross stitch

- a useful and attractive addition to sewing projects of all types
- combine cross stitches with other decorative stitches

### Sewing

- sew and combine stitches 301–309, 314 in the same manner as all other decorative stitches

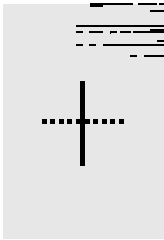

### Large cross stitch No. 310 (1st section)

- sew the first section
- machine stops automatically in the center
- the machine stops with the needle down in the fabric *even if the needle stop indicates "up"*

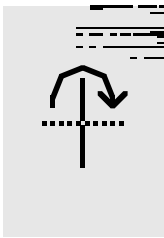

- a curved arrow appears on the screen next to the needle stop indicator
- the arrow is a reminder to turn the fabric 90° before stitching the second part of the stitch

### Large cross stitch No. 310 (2nd section)

- sew the second section
- the machine stops automatically at the end and is ready to begin the next cross stitch

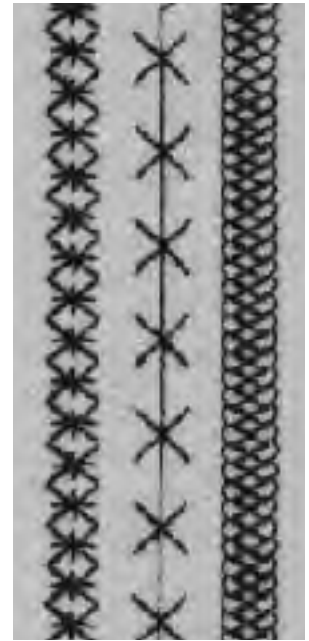

## TIPS

### Cross stitch with embroidery thread

- stitches appear fuller

### Cross stitch on a single layer

- always use stabilizer
- remove stabilizer after sewing

## Hand-look quilt stitch

Stitch:	<b>Quilt stitch No. 328, 346–350</b>
Needle:	<b>size and type suitable for the fabric selected</b>
Upper thread:	<b>monofilament</b>
Bobbin thread:	<b>30 weight, 2 ply cotton</b>
Feed-dog:	<b>up (sewing position)</b>
Presser foot:	<b>Reverse pattern foot No. 1 or Walking foot No. 50 (optional accessory)</b>

### Hand-look quilt stitch

- for all fabrics and all types of work where the look of a hand sewn running stitch is desired

### Sewing test

- the bobbin thread comes through to the top of the fabric
- 1 stitch is visible (cotton thread), 1 stitch is invisible (monofilament thread) to give a hand stitched effect

### Upper thread tension

- the upper thread tension is set automatically
- adjust if necessary to suit the fabric

### Balance

- adjust if necessary

### Sewing

- can be sewn with any needle position

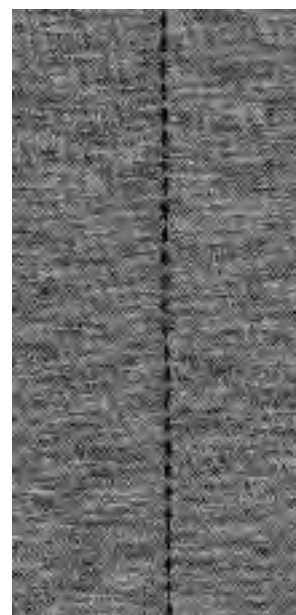

## TIPS

### Perfect corners

- activate Pattern end when approaching corner; when the machine stops automatically, sink the needle (if needed) and pivot the work

### Monofilament hints

- if the monofilament thread breaks, sew more slowly and/or reduce the upper thread tension slightly

## Decorative quilt stitches

Stitch: **Quilt stitches Nos. 326–338, 351**  
Needle: **size and type suitable for the fabric selected**  
Thread: **cotton or rayon embroidery**  
Feed-dog: **up (sewing position)**  
Presser foot: **Reverse pattern foot No. 1**

### **Straight stitch No. 326**

- a short straight stitch (2mm)
- particularly suitable for piecing patchwork

### **Quilt stitches**

- suitable for all fabrics and quilting
- especially applicable for crazy quilting

### **Balance**

- adjust if necessary

### **Sewing**

- select quilt stitch and sew
- all quilt stitches can be combined and programmed in memory

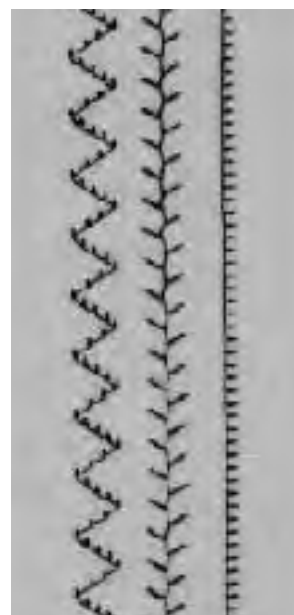

## TIP

### **Perfect corners**

- activate Pattern End; when the machine stops automatically, sink the needle (if needed) and pivot the work



## Freehand quilting

Stitch: **Straight stitch No. 1**  
 Needle: **size and type suitable for the fabric selected**  
 Thread: **cotton or monofilament**  
 Feed-dog: **down (darning position)**  
 Presser foot: **Darning foot No. 9 or Quilting foot No. 29**

### Freehand quilting

- for all freehand quilt work

### Preparation

- pin and baste top layer, batting, and lining together
- attach the slide-on sewing table or place machine in a cabinet

### Holding the work

- start in the center and work out toward the edges
- hold the fabric with both hands like an embroidery frame

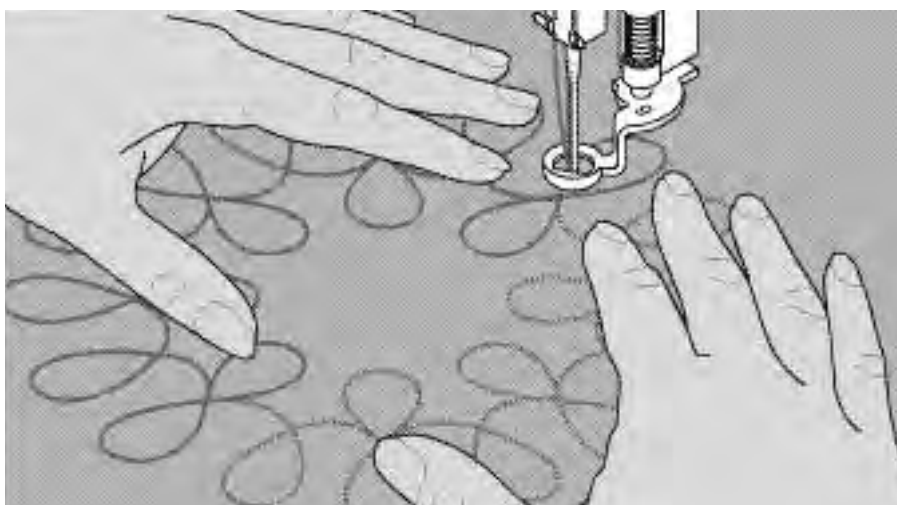

### Quilting a design

- turn the work using smooth, round movements to form the design of your choice (either freehand or following a template)

### Stipple quilting

- this technique covers the entire surface of the fabric
- the lines of stitching are rounded without any sharp corners; they never cross or touch one another



## TIPS

### Freehand quilting and darning

- both techniques are based on the same free-motion principles

### Thread breaks

- usually as a result of sudden or jerky movements – move the fabric smoothly and at an even pace

### Poor stitch formation

- if the thread forms loops, the work is being moved too quickly
- if knots are forming on the underside, the work is being moved too slowly

### Monofilament hints

- if the monofilament thread breaks, sew more slowly and/or reduce the upper thread tension slightly

## Using decorative stitches with functions

Stitch: **Any decorative stitch**  
 Needle: **size and type suitable for the fabric selected**  
 Thread: **cotton or rayon embroidery**  
 Feed-dog: **up (sewing position)**  
 Presser foot: **Reverse pattern foot No. 1 or  
 Open Embroidery foot No. 20 or  
 Embroidery Foot No. 6 (optional accessory)**

### Combining basic settings and functions

- you can achieve some exciting effects by combining basic settings with various functions

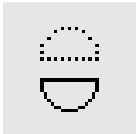
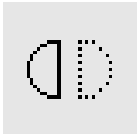

Horizontal mirror image  
 Vertical mirror image

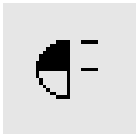
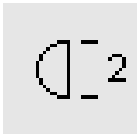

Pattern end 1-9x  
 Half pattern

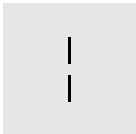

Balance  
 Long stitch function

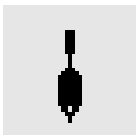
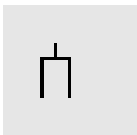

Double needle limitation 2-5 mm  
 Wing needle limitation

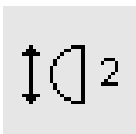
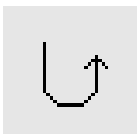

Continuous reverse sewing  
 Pattern extend 2-5x

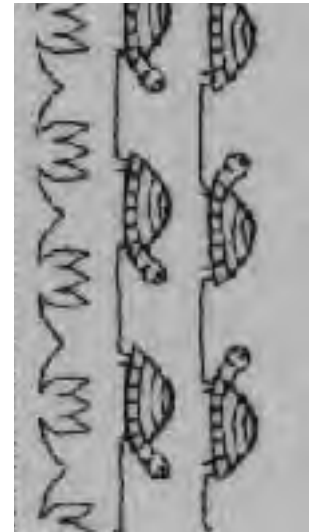
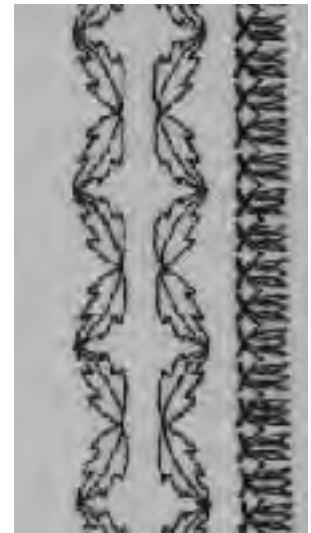

### Balance

- use balance to obtain variations on stitches
- the stitch will be stretched open or compressed, depending on the number of balance steps
- for additional information on the balance function, see page 44

### Method

- select stitch
- select function
- several functions can be activated for one stitch

### Deleting functions

- press the external clr button
- delete special functions individually by touching the appropriate symbol



## TIPS

### Variations with basic settings and functions

- before starting a new combination, clear all functions previously used

### Decorative stitches on single layer fabric

- always use stabilizer
- remove stabilizer after sewing

### Activate needle stop down when sewing long rows of stitches

- needle stays in fabric when stopping to reposition work

### Single Pattern

- the machine stops automatically at the end of each individual stitch pattern

## Practical and decorative stitches in memory

- the memory capacity is 1023 individual stitch patterns
- the memory has 255 banks
- each bank can be sub-divided as desired
- most practical and decorative stitches as well as letters and numbers can be combined, programmed, and saved in memory
- exceptions: buttonholes
- all saved stitches remain in the memory when the machine is turned off
- all saved stitches and combinations can be recalled at any time

### Programming practical and decorative stitches

- open the memory by pressing the external mem button
- touch mem 1 to access the memory storage screen
- select an empty memory bank
- touch OK to return to the previous screen
- select the desired stitch
- the stitch appears in the mem field
- select the next desired stitch
- continue in this manner until the desired combination of stitches has been programmed
- to save, touch store

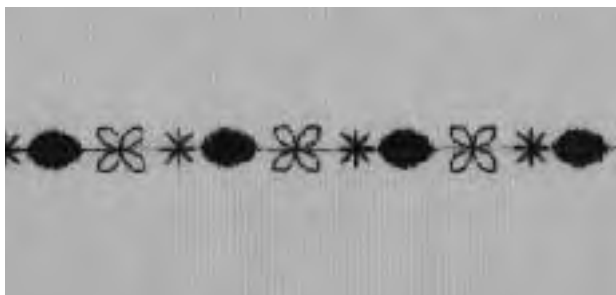

### Example of programmed stitch combination

- select a memory bank following the directions above
- touch stitch 407 one time
- touch stitch 102 one time
- touch stitch 711 one time
- begin stitching; the stitches will continuously alternate
- to save, touch store

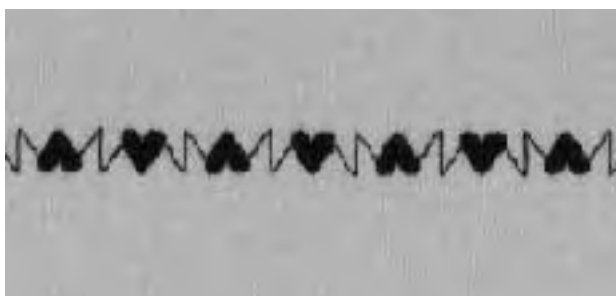

### Examples of programmed stitch with function

- select a memory bank following the directions above
- touch stitch 413 one time
- activate vertical mirror image
- touch stitch 413 one time
- begin stitching; the stitches will continuously alternate facing up and down
- to save, touch store



- select a memory bank following the directions above
- touch stitch 104 one time
- activate vertical mirror image
- touch stitch 104 one time
- begin stitching; the stitches will continuously alternate facing up and down
- to save, touch store

**Stitch combination as single repeat**

- select a memory bank following the directions on the previous page
- touch stitch 409 one time
- touch stitch 616 two times
- on the toolbar, activate Pattern end 2
- stitch; the machine stops automatically at the end of the second combination of stitches
- to save, touch store

**Stitch combination with mirror image as single repeat**

- select a memory bank following the directions on the previous page
- touch stitch 109 one time
- touch stitch 414 one time
- activate horizontal mirror image
- touch stitch 414 one time
- activate horizontal mirror image
- touch stitch 109 one time
- on the toolbar, activate Pattern end 1
- stitch; the machine stops automatically at the end of the combination of stitches
- to save, touch store

**TIPS****Decorative stitch combination with embroidery thread**

- stitches appear fuller

**Stitch combinations on single layer of fabric**

- always use a stabilizer
- remove stabilizer after sewing

## Letters and numbers in memory

- the memory capacity is 1023 individual stitch patterns
- the memory has 255 banks
- each bank can be sub-divided as desired
- most practical and decorative stitches as well as letters and numbers can be combined, programmed, and saved in memory
- exceptions: buttonholes and eyelets
- all saved stitches remain in the memory when the machine is turned off
- all saved stitches and combinations can be recalled at any time

### Programming letters and numbers

- open the memory by pressing the external mem button
- touch mem 1 to access the memory storage screen
- select an empty memory bank
- touch OK to return to the previous screen
- select the desired letter
- the letter appears in the mem field
- select the next desired letter
- continue in this manner until the desired combination of letters has been programmed
- to save, touch store

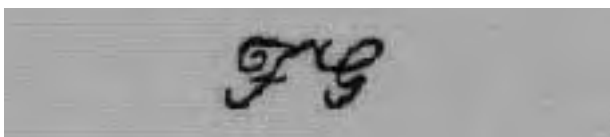
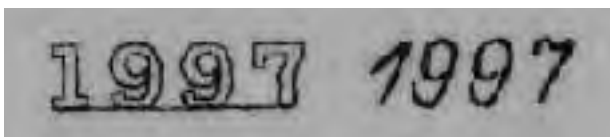
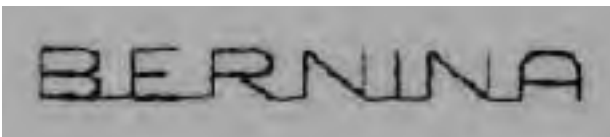
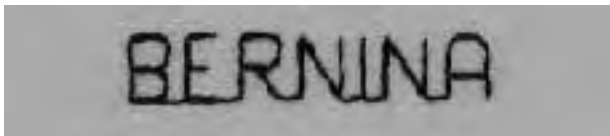

### Examples of programming letters

- select a memory bank following the directions above
- press the external alphabet button
- touch the block letter alphabet
- touch the appropriate letters to spell "BERNINA"
- on the toolbar, activate Pattern end 1
- begin stitching; the letters will continuously stitch, automatically stopping after the "A"
- to save, touch store
- for double length letters, select Pattern the Extend 2x function before programming

### Examples of programming numbers

- follow the directions above for programming letters, selecting numbers instead
- begin stitching; the numbers will continuously stitch, automatically stopping after the last one
- to save, touch store

### Examples of programming small monograms

- select a memory bank following the directions above
- press the external alphabet button
- touch the 5mm script alphabet
- touch the desired letters
- on the toolbar, activate Pattern end 1
- begin stitching; the letters will continuously stitch, automatically stopping after the last one
- to save, touch store

### Securing

- select the Securing function
- the first and last letters will be secured

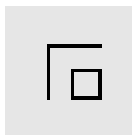

## TIPS

### Activate Pattern end after programming

- the machine will sew the program once and stop

### Embroidering letters on a single layer of fabric

- always use stabilizer
- remove stabilizer after sewing

## Balance

All stitches are tested and adjusted before the machine leaves the factory; however, shipping and transporting can affect the setting of the balance function.

Different fabrics, threads and stabilizers can distort the stitch patterns so that they are too long (do not close properly) or too short (have a condensed appearance).

The electronic balance function can be used to correct these distortions so that stitches can be adjusted for a perfect formation on the fabric of your choice.

Stitch: **all stitches**  
 Needle: **all types, 70–110**  
 Thread: **all threads**  
 Feed-dog: **up (sewing position)**  
 Presser foot: **as indicated on screen**

### Test sewing

- it is always a good idea to test sew with the materials you intend to use – fabric, stabilizer and threads



### Open balance

- touch the arrow on the functions toolbar
- scroll the functions
- touch "b"

## Balance and practical stitches / decorative stitches

- soft fabrics such as jerseys and tricot have a tendency to stretch under the presser foot
- stitches such as Honeycomb may therefore not close correctly
- this can be corrected with the balance function

### Balance for practical stitches

- the stitch as it should look, e.g. Honeycomb, is in the center of the screen
- possible stitch distortions are shown to the right and left of the correct stitch
- the arrows at the bottom of the screen show in which direction the stitch should be corrected

Note: the honeycomb stitch graphic will be seen on-screen for all practical stitches

### Corrections

- touch the appropriate arrow to balance the stitch
- the number of steps is shown above the arrow
- 2–5 steps are normally sufficient to balance practical stitches (max. 50 steps)

### Balance for decorative stitches

- the method is the same as for practical stitches
- Note: the satin stitched oval graphic will be seen on-screen for all decorative stitches

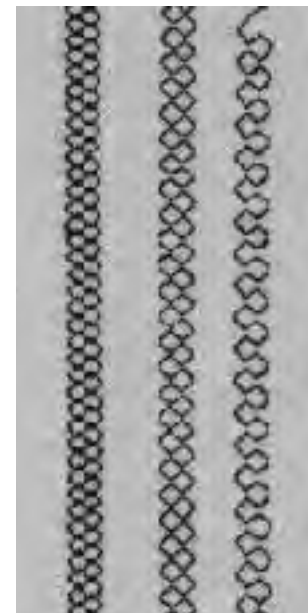

overlapping stitch    balanced stitch    open stitch

# Index

<b>A</b>		<b>H</b>		<b>S</b>	
Auto buttonholes	25	Honeycomb stitch edges	12	Securing program (straight stitch)	3
Auto round and keyhole buttonholes	26			Sewing knits	12,13
Automatic darning program	33			Stitch counter buttonholes	27
<b>B</b>		<b>J</b>		<b>Stitch counter buttonholes</b>	
Balance practical/decorative stitches	44	Jersey overlock seam	9	Straight stitch buttonholes	24
Bar tack program	20			Straight stitch with securing program	3
Basting	16	<b>L</b>		Straight stitch	2
Blind hem	17	Letters and numbers in memory	43	Stretch overlock seam	10
Button Sew-on program	29	Long Stitch	15	Stretch/Super stretch seam	8
Buttonholes	21–28	<b>M</b>		<b>T</b>	
<b>C</b>		Manual buttonholes	28	Triple straight stitch seam	8
Contents	1	Manual darning	34	<b>U</b>	
Cross stitches	36	Memory – letters and numbers	43	Universal stitch – sewing on elastic	18
<b>D</b>		Memory – practical and decorative stitches	41–43	<b>V</b>	
Darning programs	33	<b>N</b>		Vari-overlock – ribbing	13
Darning, mending	31–34	Numbers and letters in memory	43	Vari-overlock seam	9
Decorative stitches in memory	41–43	<b>P</b>		<b>Z</b>	
Decorative stitches with functions	40	Personal (altered) memory	6	Zig-zag stitch	5
Decorative stitches	35	Practical stitch hems	11	Zippers	14
Double overlock seam	9	Practical stitch seams	7–10	<b>Q</b>	
<b>E</b>		Practical stitches in memory	41–43	Quilt stitches	38
Edge stitching	4	<b>R</b>		Quilt/hand look stitches	37
Edges of knits with elastic	31	Reinforced darning program	33	<b>F</b>	
Elastic – sewing on	18, 19	Reinforcing edges on woven fabrics	32	Flat joining seam	10
Eyelets, straight stitch	30	Ribbing with overlock	13	Freehand quilting	39
Eyelets, zig-zag	30	<b>G</b>		<b>G</b>	
<b>F</b>		Gathering stitch – sewing on elastic/cord	18	<b>G</b>	

