

1

10 x 10 cm

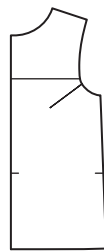

fvouw draadrichting

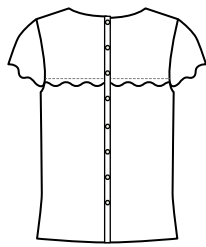
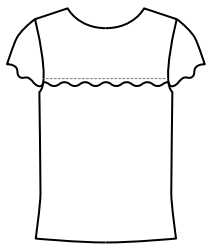
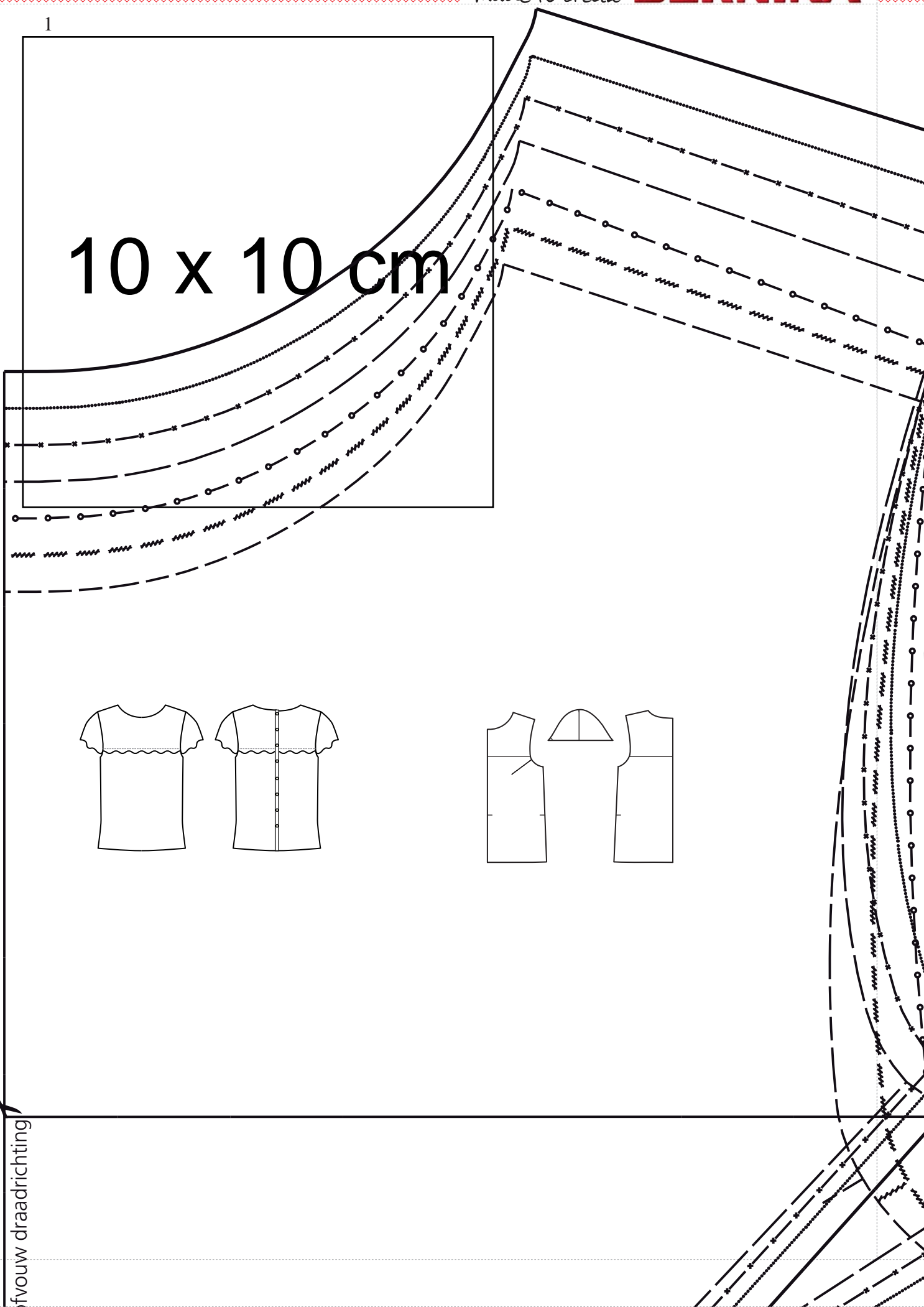
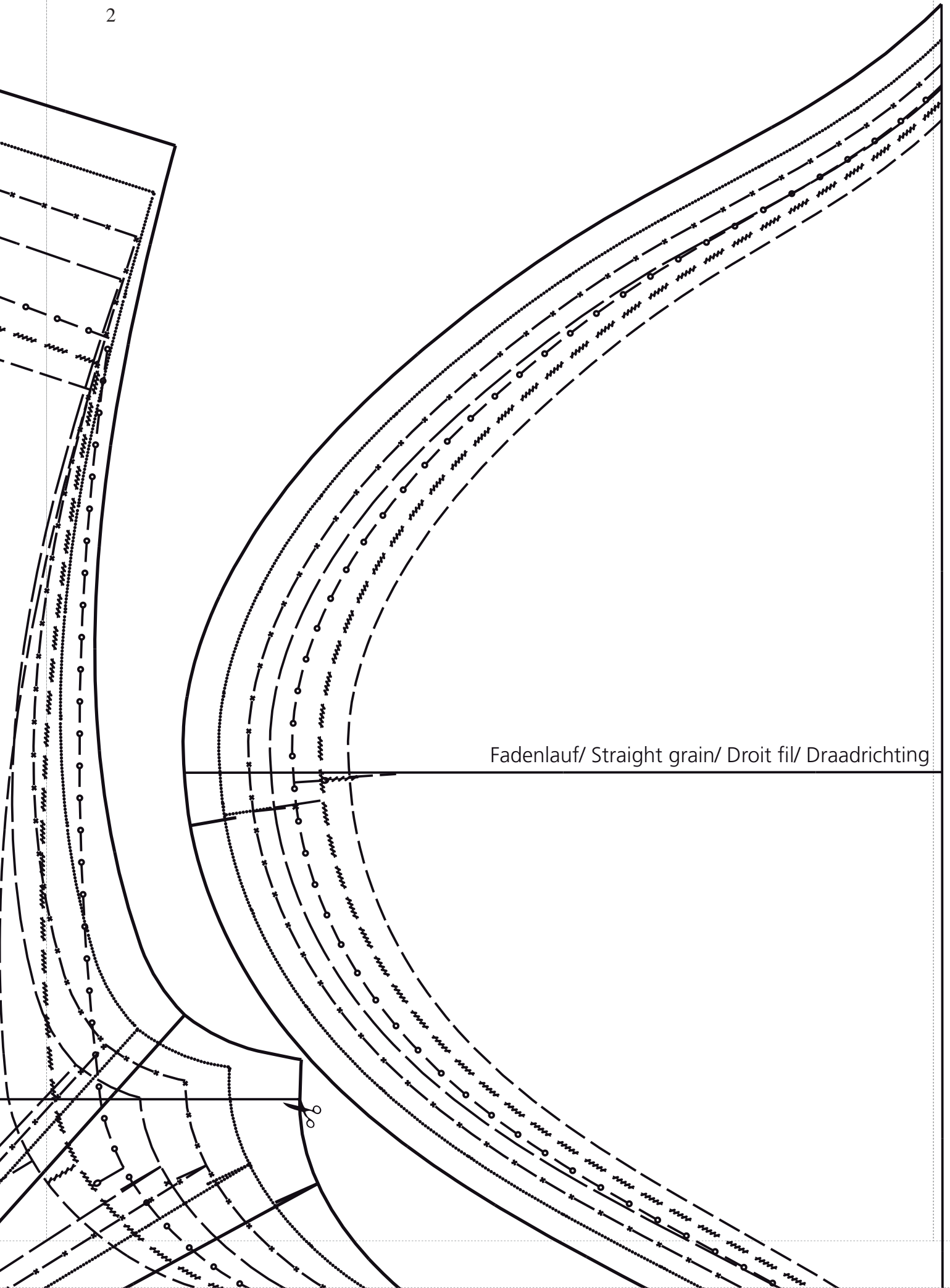

Fadenlauf/ Straight grain/ Droit fil/ Draadrichting

nting

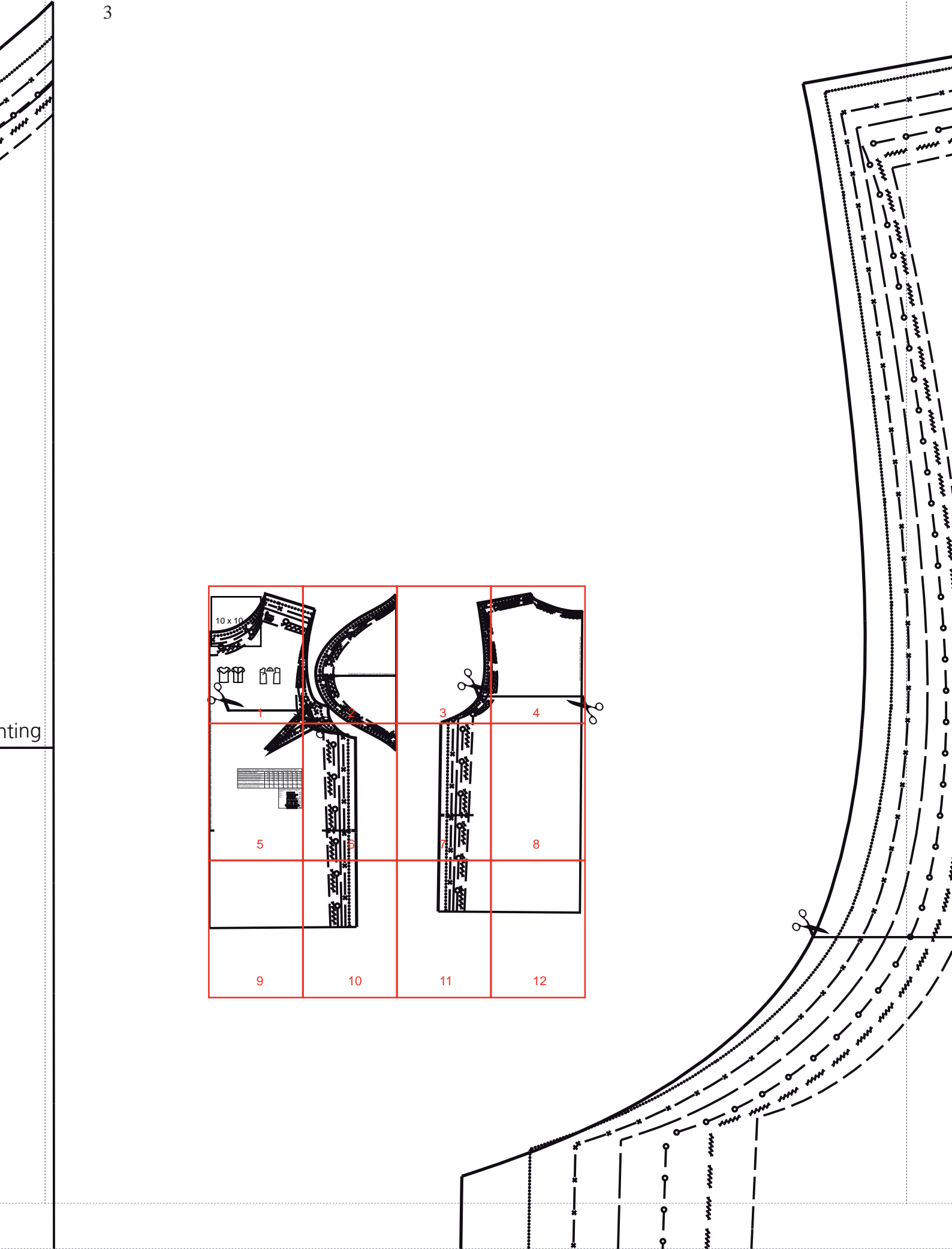
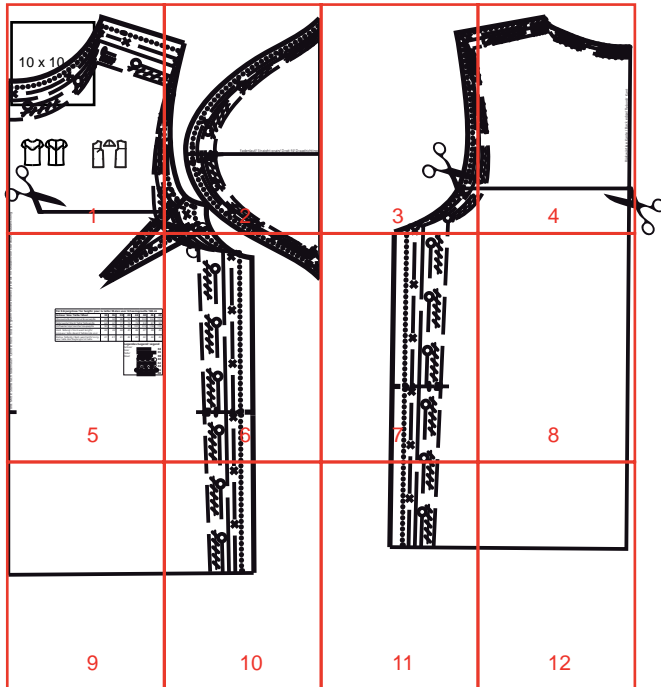

4

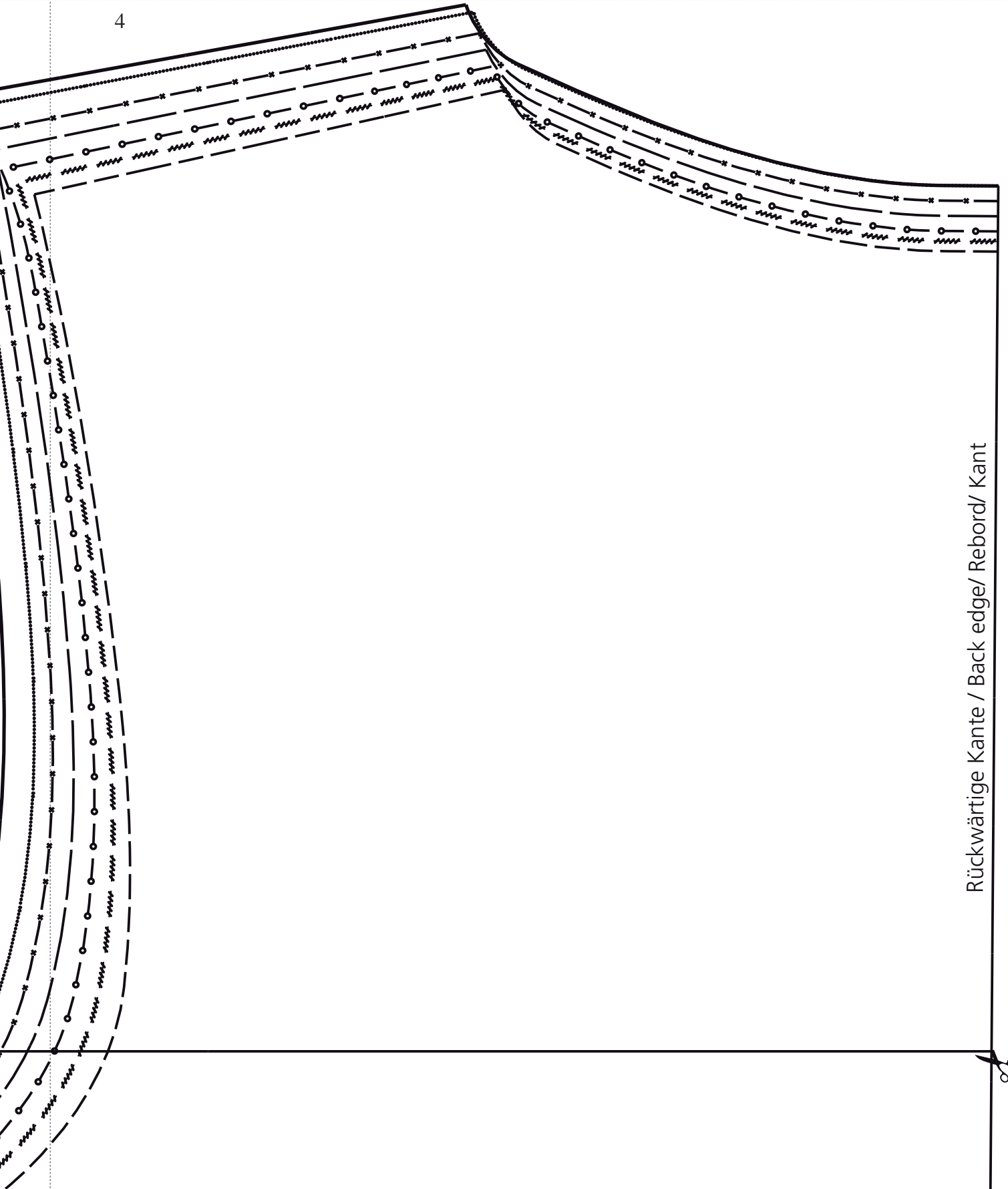

Rückwärtige Kante / Back edge/ Rebord/ Kant



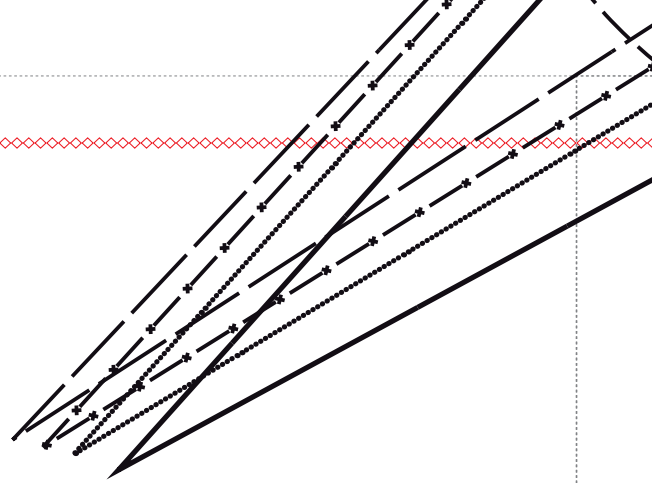

Für Körpergröße/ for heighth/ pour la taille/ Maten voor lichaamsgrootte 168 cm								
Größe/ Size/ Taille/ Maat	34	36	38	40	42	44	46	48
Oberweite/Bust/ Poitrine/ Bovenwijdte	80	84	88	92	96	100	104	110
Taillenweite/ Waist/ Taille/ Taillewijdte	64	67	71	75	79	83	87	94
Hüftweite/ Hip/ Hanche/ Heupwijdte	90	93	96	99	102	105	108	114
Vord. Taillengl./ Front waist length/ Longueur taille devant/ Taillelengte voor	42	43	44	45	46	47	48	49
Rückw. Taillengl./ Back waist lenth/ Longueur taille dos/ Ruglengte tot taille	41	41	41	42	42	42	42	43

Legendev/Legend/ Légend	
Größe/	
Size/	----- 34
Taille/	————— 36
Maat	//// //// //// //// 38
	—○—○—○—○— 40
	————— 42
	— * — * — * 44
 46
	————— 48

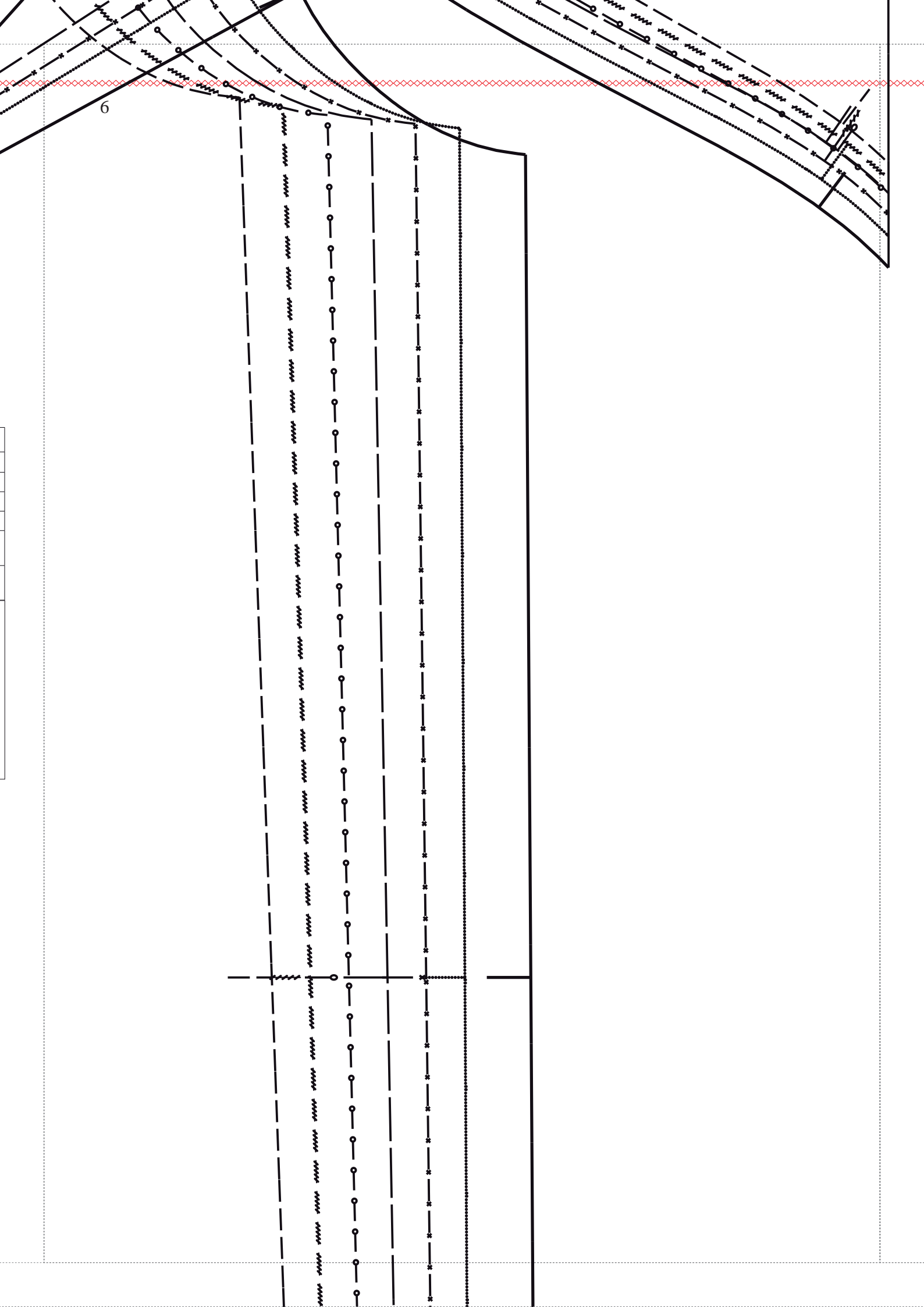

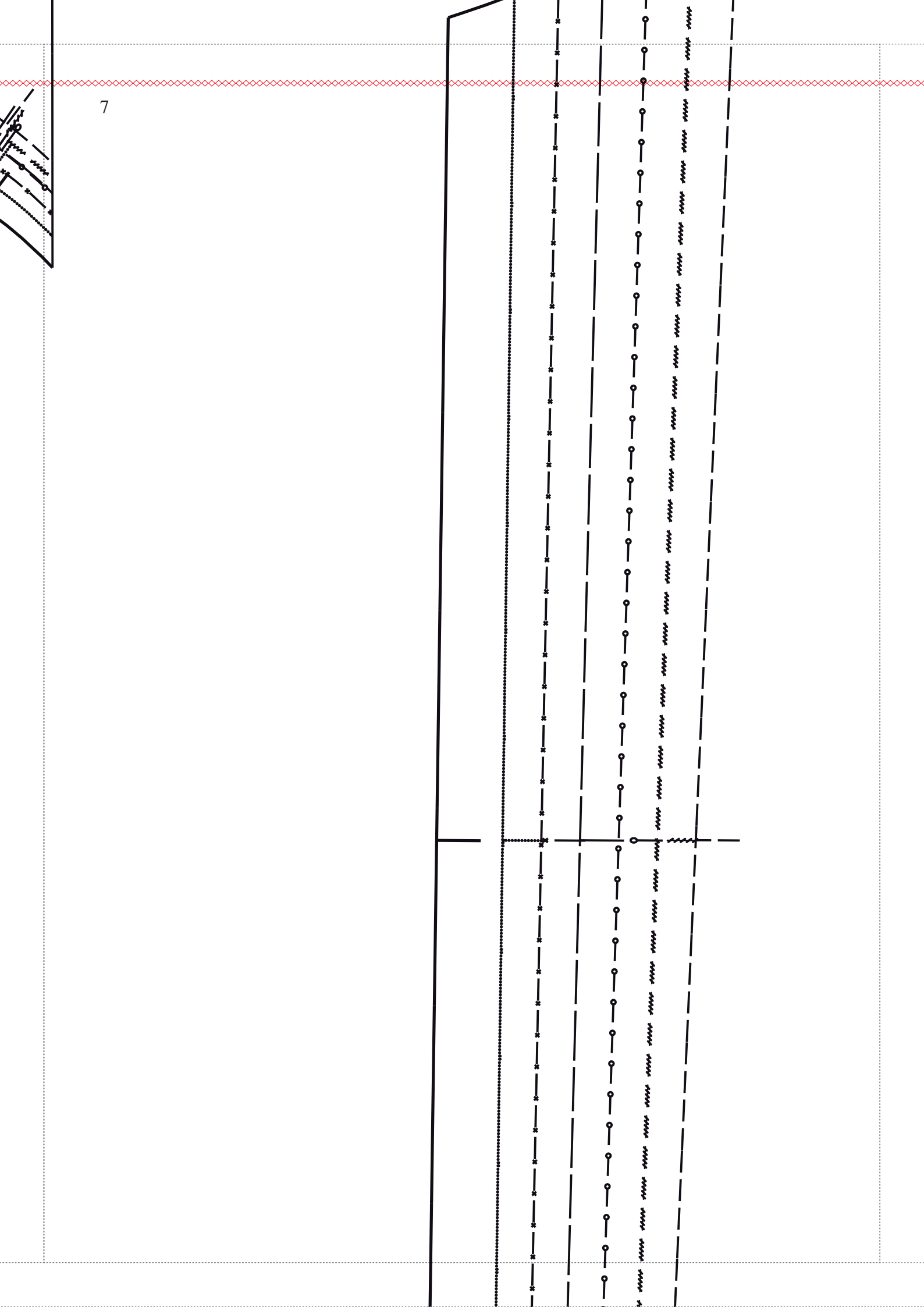

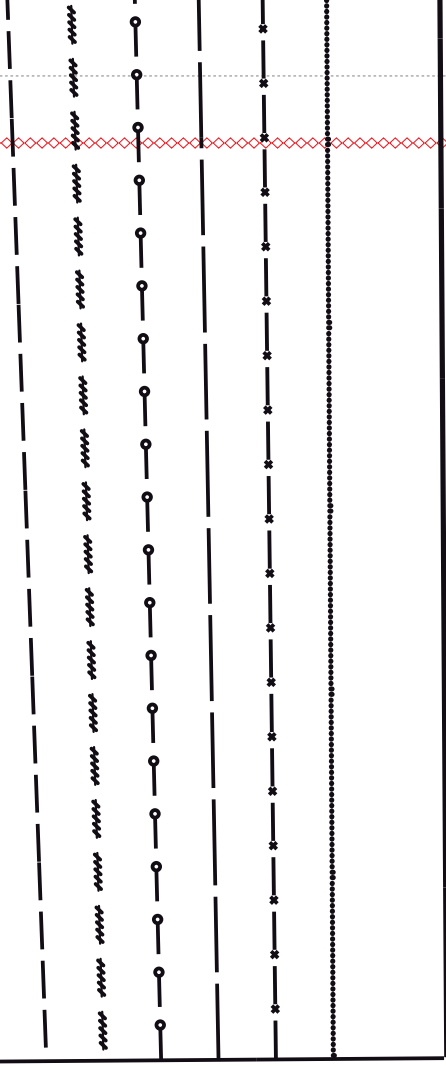

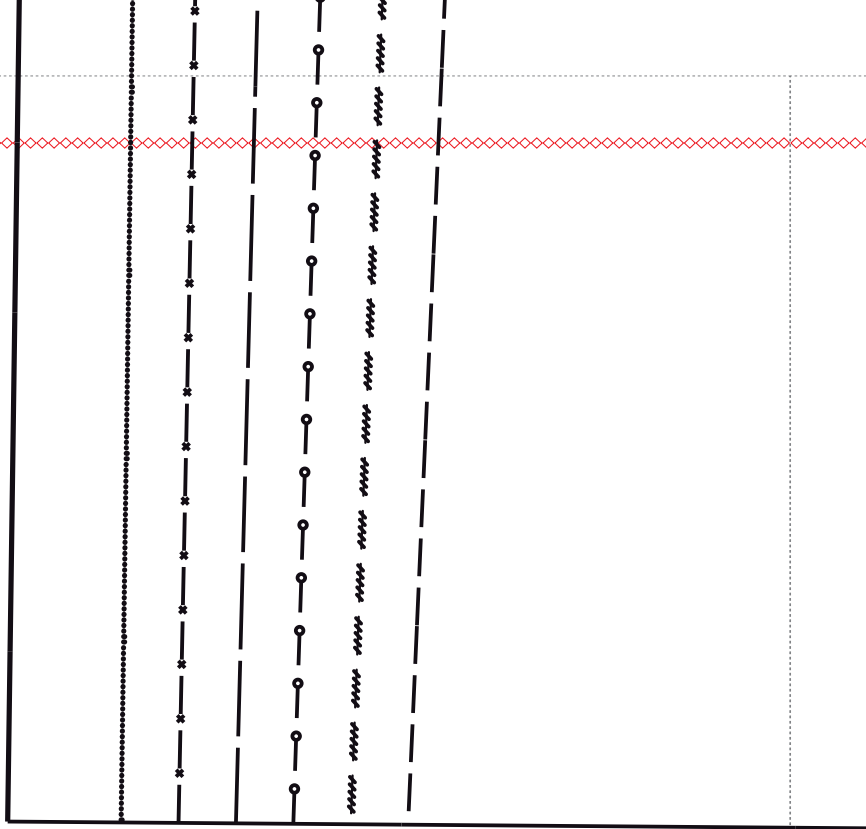

Keine Ausgabe mehr versäumen!



Im Abonnement erhalten Sie garantiert alle Ausgaben, und das viermal im Jahr.

► ICH ABONNIERE DIE INSPIRATION FÜR 1 JAHR (4 AUSGABEN)

Land

- Schweiz 29 CHF
 Europa 24 EURO
 Übersee 43 US\$/59 AUD

alle Preise inkl. MwSt. und Porto

Sprache

- Deutsch
 Englisch
 Französisch
 Niederländisch

Name

Geburtsjahr

Strasse, Nr.

PLZ, Ort

Telefon

**Mein Abonnement beginnt mit der jeweils nächsten Ausgabe.
 Es läuft nach Erhalt von 4 Heften automatisch weiter, sofern ich nicht
 rechtzeitig vor Ablauf kündige.**

**BERNINA International AG, Redaktion Inspiration, CH-8266 Steckborn
 Fax +41 52 762 13 12, E-Mail: redaktion@bernina.com**