

1

10 x 10 cm

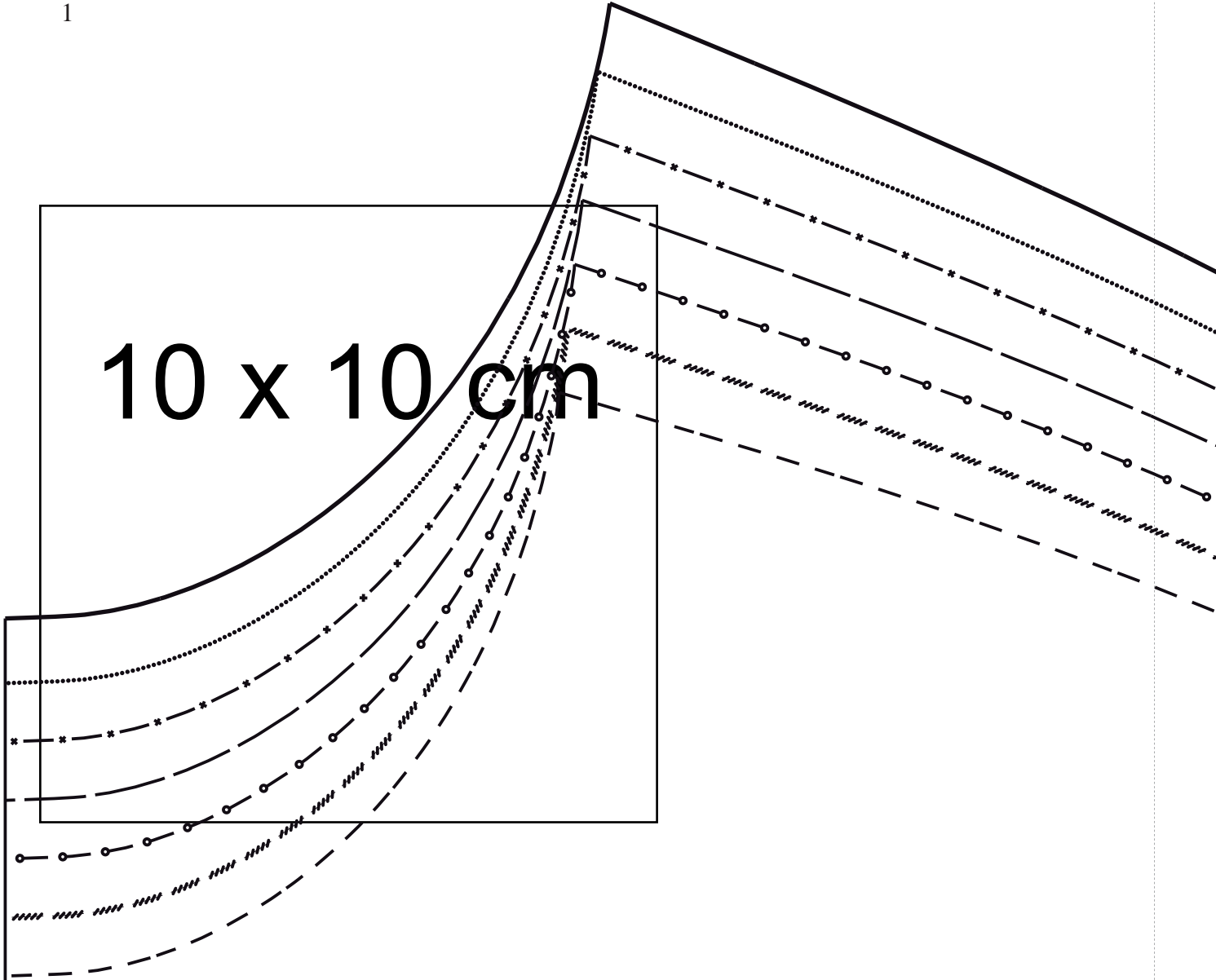

u endroit pli droit fil/ Middenvoor stofvouw draadrichting

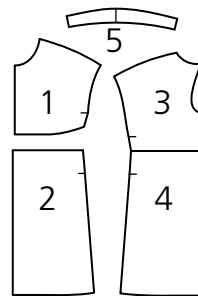

## Für Körpergröße/ for height/ pour la taille/ Maten voor lichaamsgrootte 168 cm

Grösse/ Size/ Taille/ Maat	34	36	38	40	42	44	46	48
Oberweite/Bust/ Poitrine/ Bovenwijdte	80	84	88	92	96	100	104	110
Taillenweite/ Waist/ Taille/ Taillenwijdte	64	67	71	75	79	83	87	93
Hüftweite/ Hip/ Hanche/ Heupwijdte	90	93	96	99	102	105	108	114
Vord. Taillenlg./ Front waist length/ Longueur taille devant/ Taillelengte voor	42	43	44	45	46	47	48	49
Rückw. Taillenlg./ Back waist length/ Longueur taille dos/ Ruglengte tot taille	41	41	41	42	42	42	42	43

## Legende/ Legend/ Légend

Grösse/	-----	34
Size/	-----	36
Taille/	-----	38
Maat	-----	40
	-----	42
	-----	44
	-----	46
	-----	48

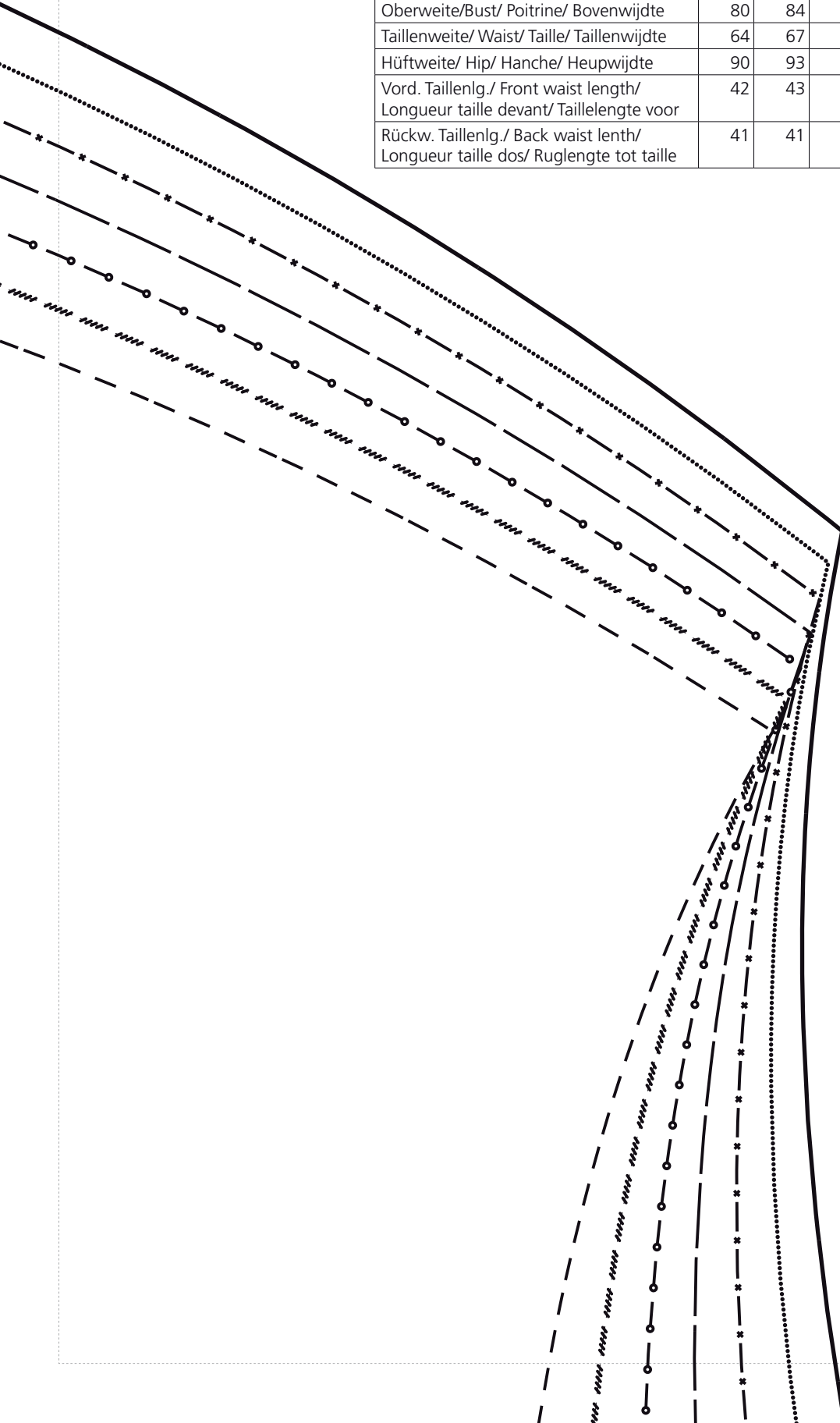

18  
10  
93  
14  
49  
43  
4  
6  
8  
0  
2  
4  
6  
8

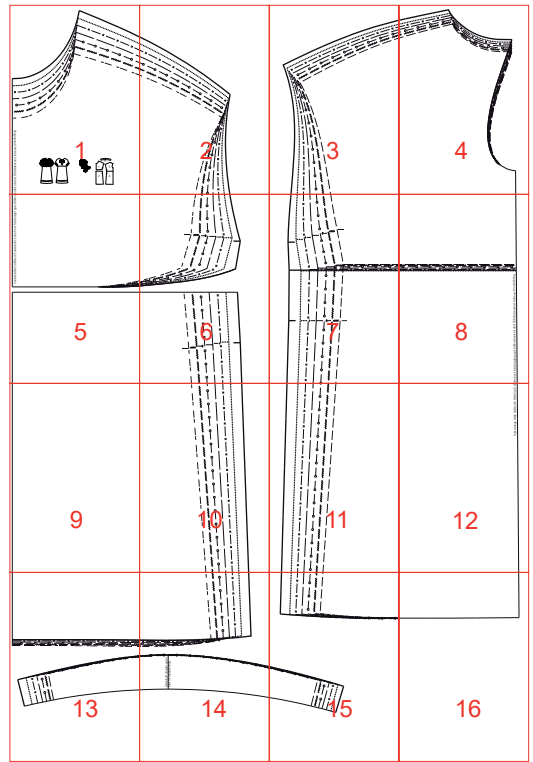
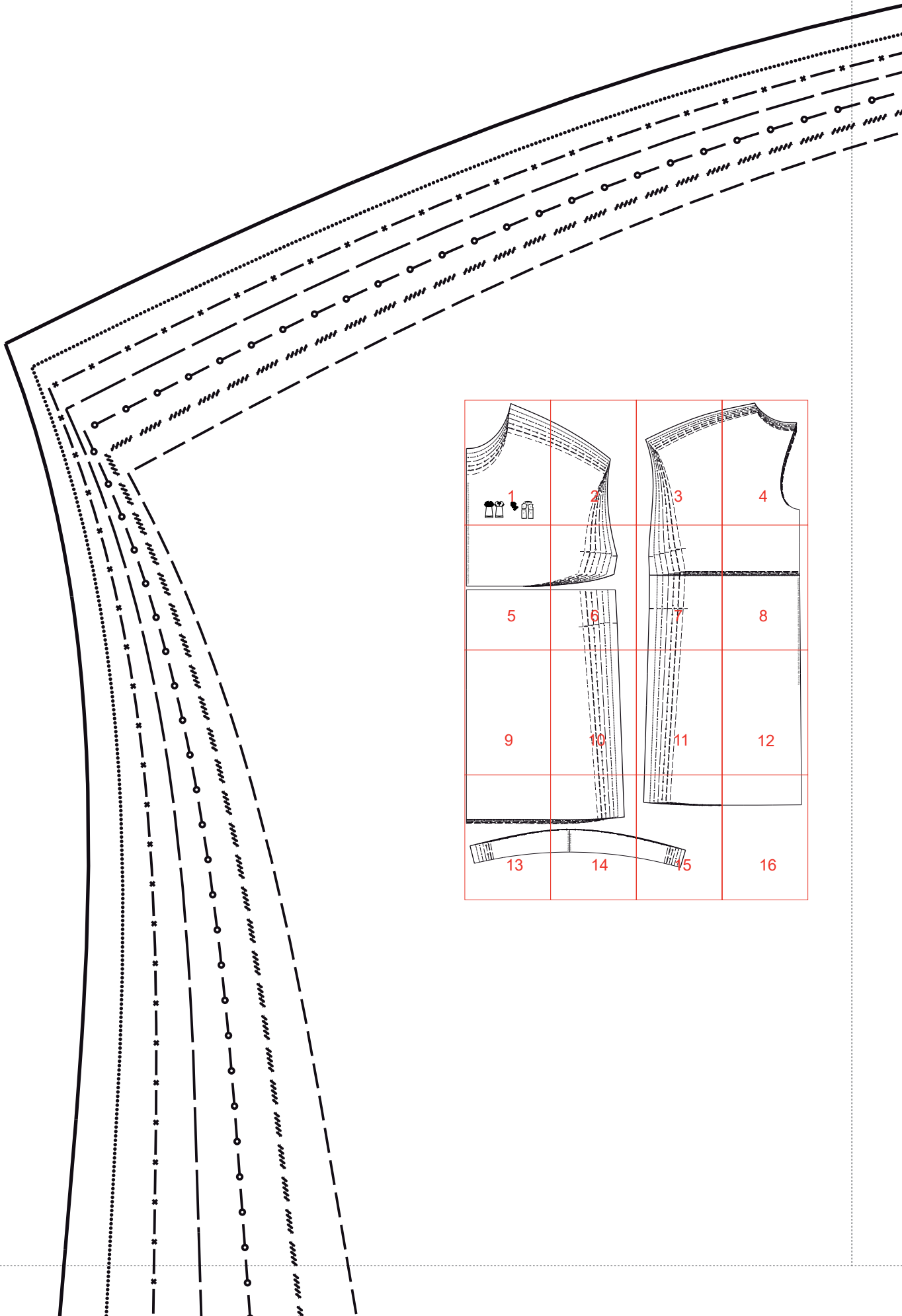

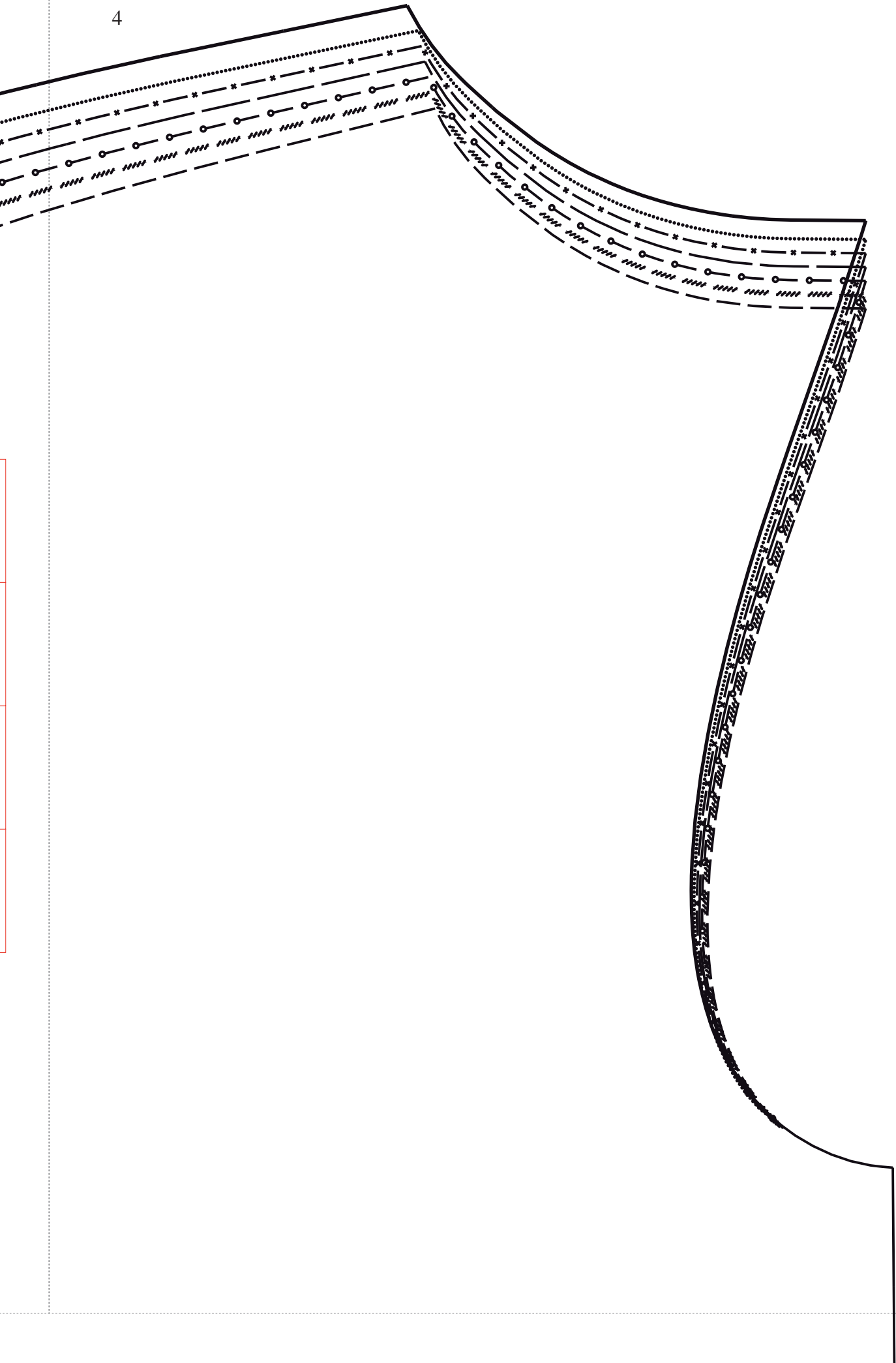

Vordere Mitte Stoffbruch Fadenlauf/ Centre front fold straight grain/ Milieu endroit p

5



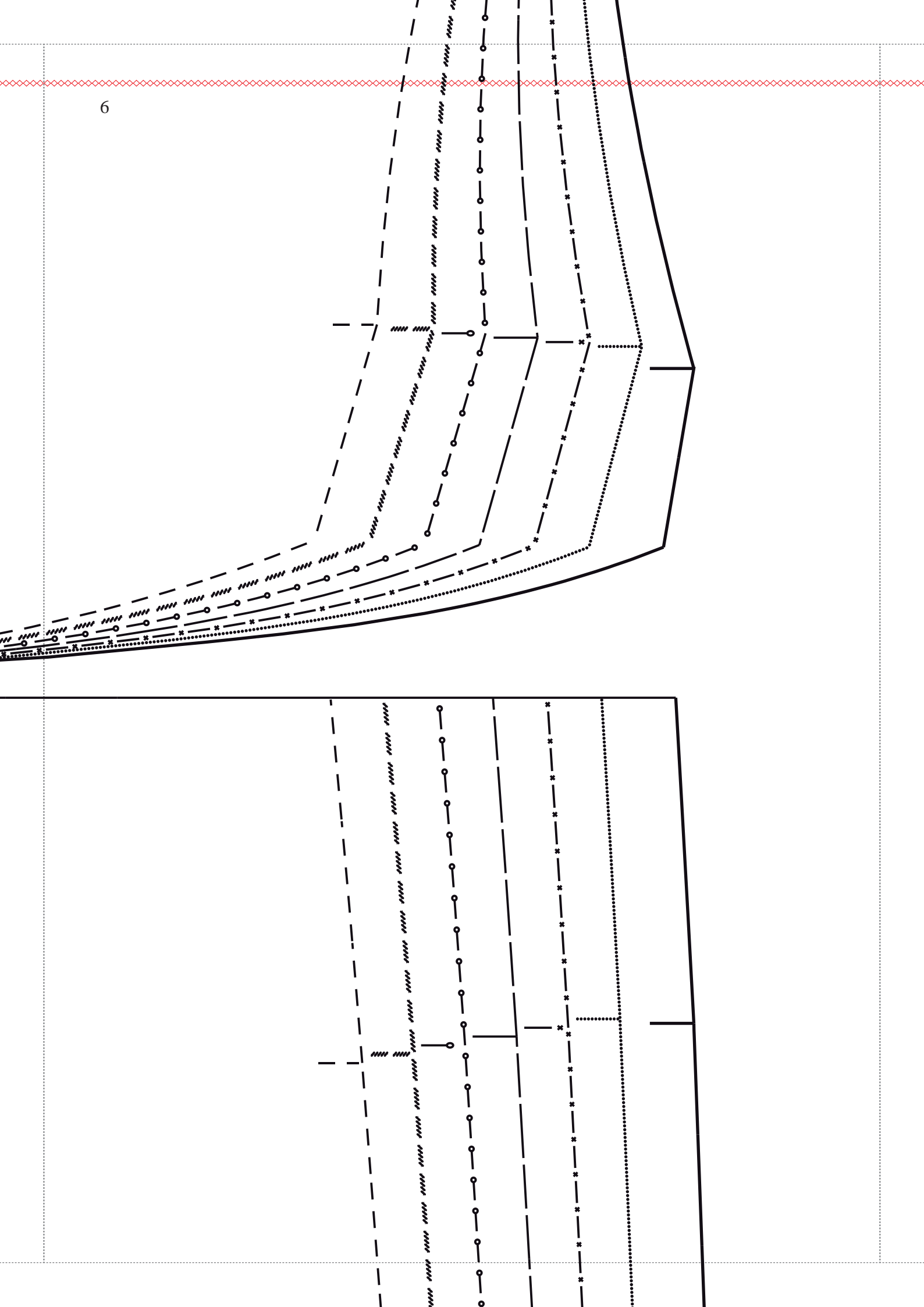

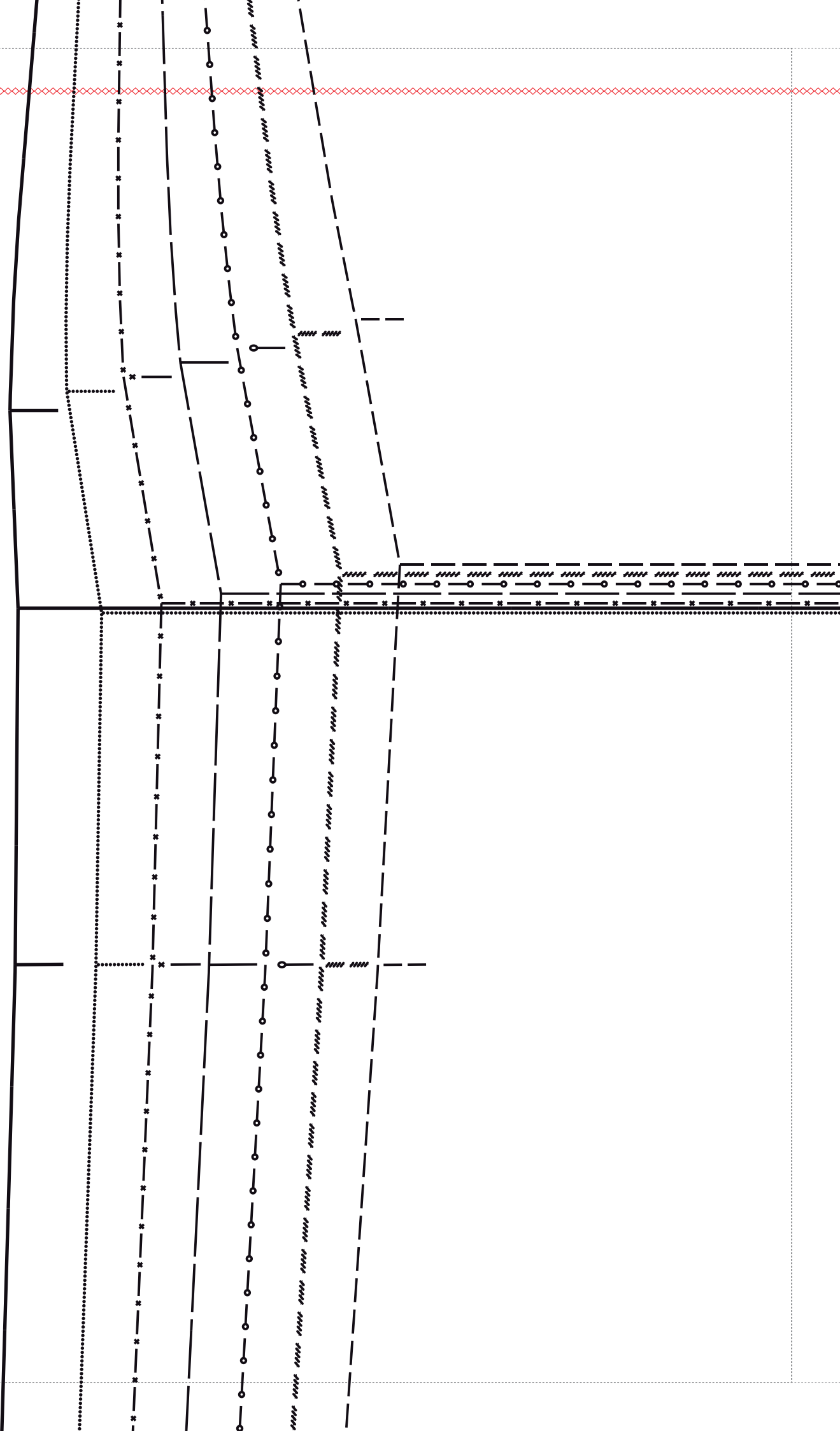



Centre back fold straight grain/ Milieu envers pli/ Middenachter stofvouw Draadrichting





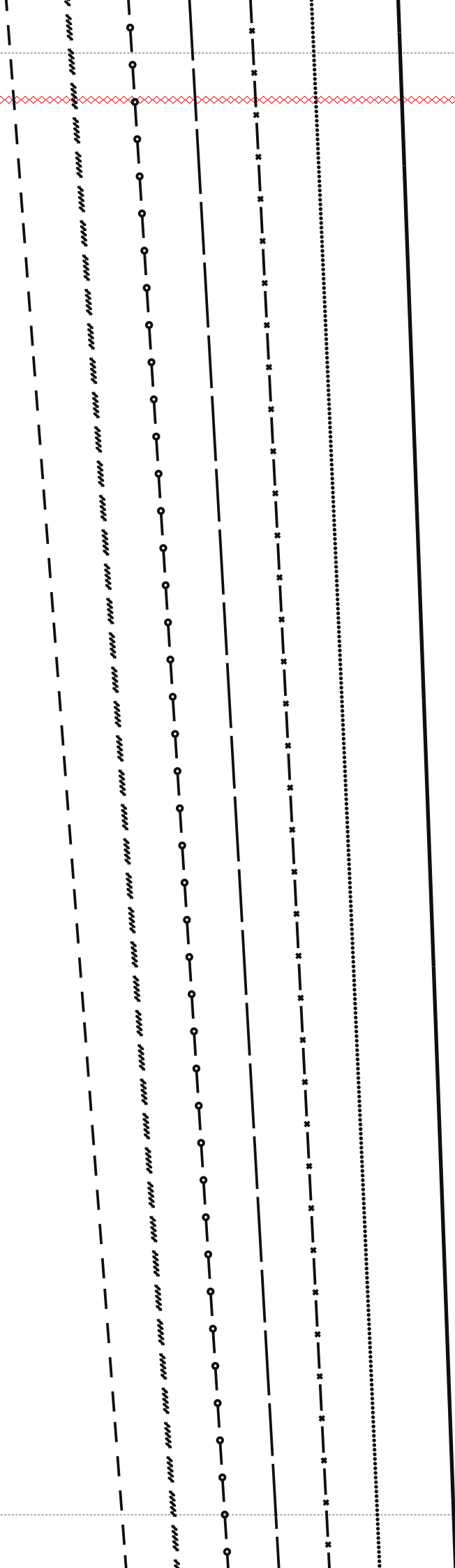

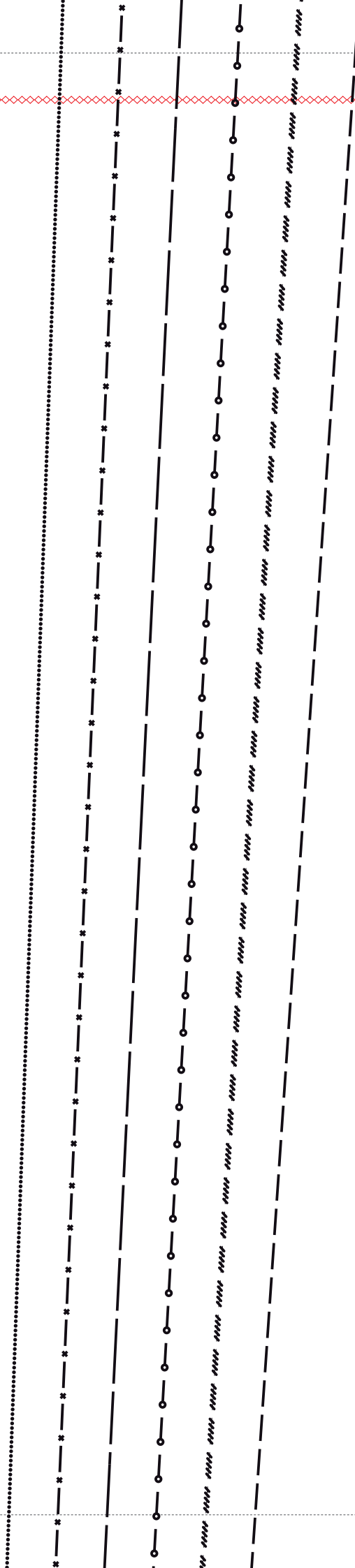



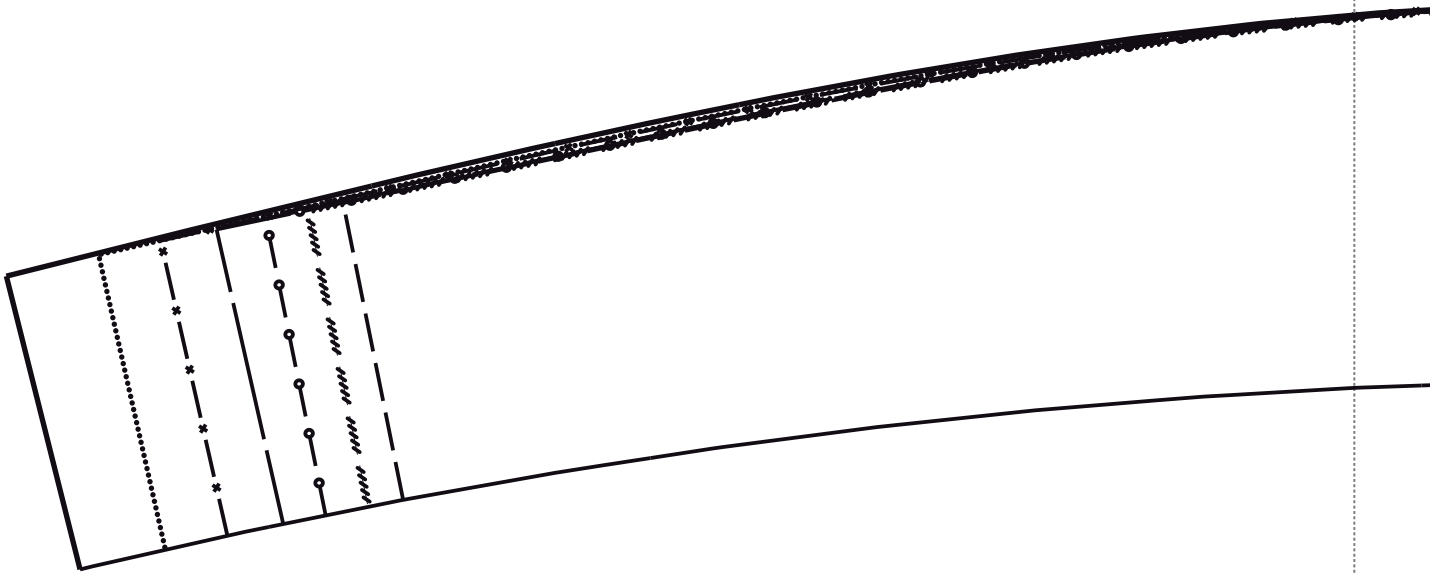

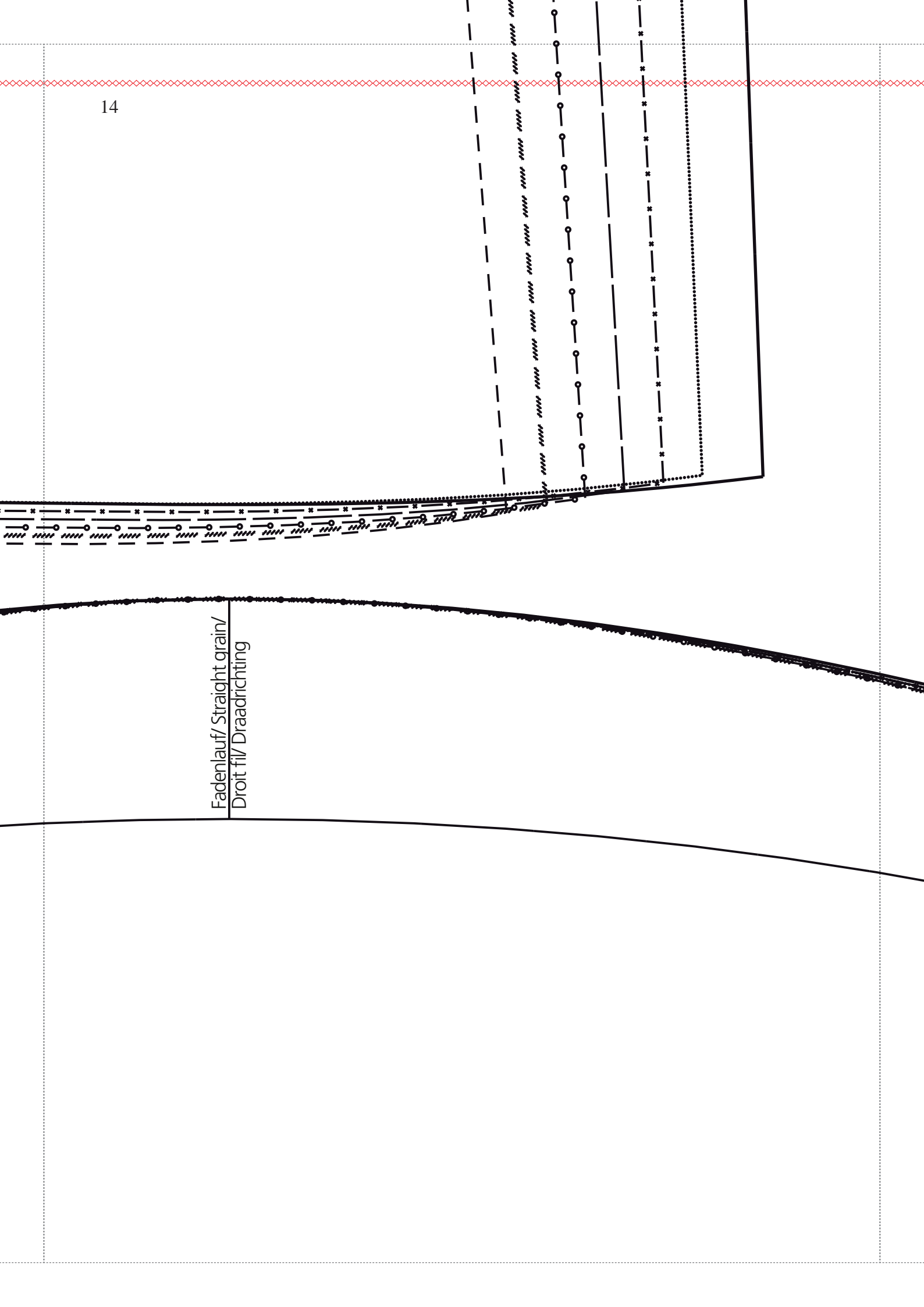

Fadenlauf/ Straight grain/  
Droit fil/ Draadrichting

15

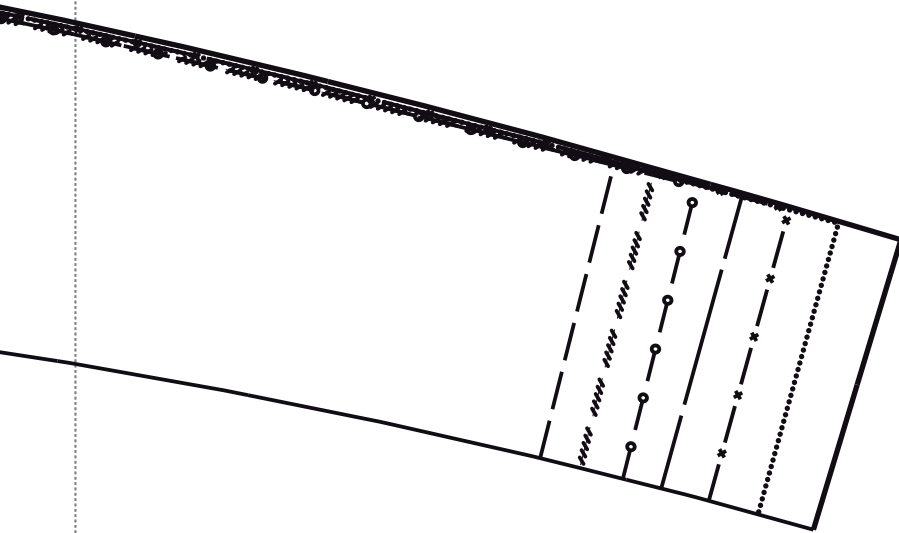
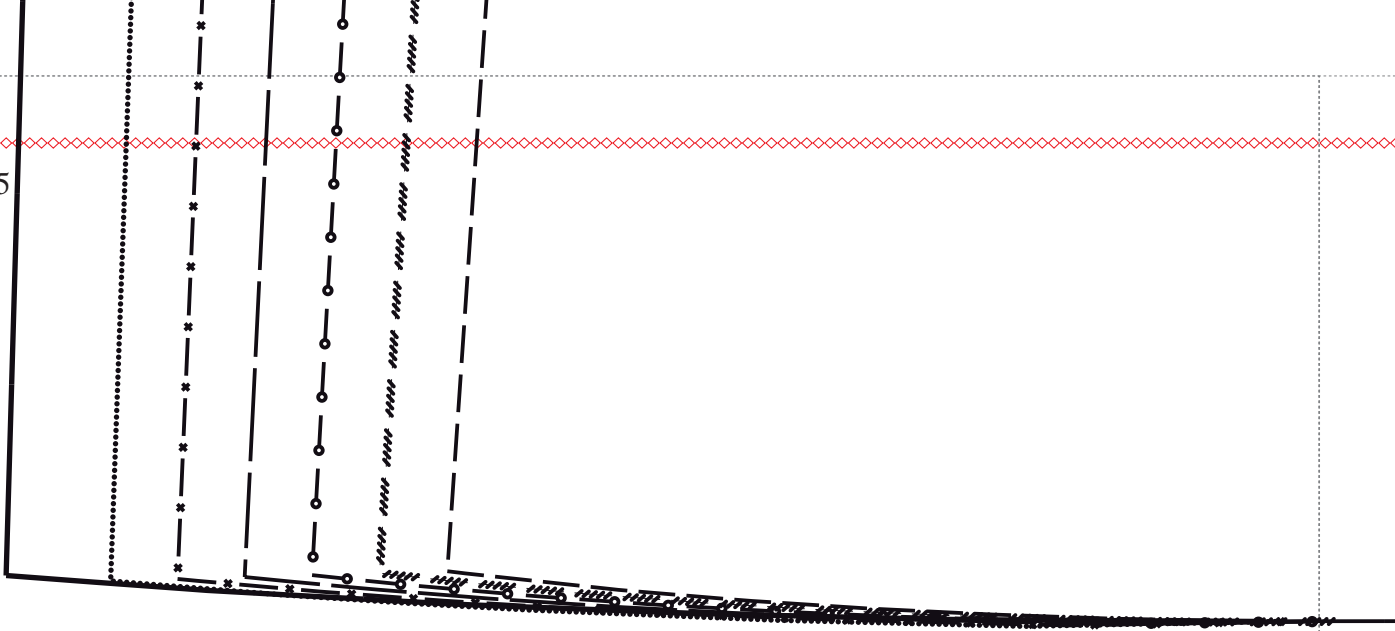

## Keine Ausgabe mehr versäumen! Never miss another issue !



**Im Abonnement erhalten Sie garantiert alle Ausgaben,  
und das viermal im Jahr.**

**With a subscription you can be sure of receiving all 4 issues per year.**

► ICH ABONNIERE DIE INSPIRATION FÜR 1 JAHR (4 AUSGABEN)

► I'D LIKE A YEAR'S SUBSCRIPTION TO INSPIRATION (4 ISSUES)

Land - Country

- Schweiz - Switzerland    CHF 29  
 Europa - Europe    EUR 24  
 Übersee - Overseas    USD 43 / AUD 59

alle Preise inkl. MwSt. und Porto - All prices inclusive of VAT and postage

Sprache - Language

- Deutsch - German  
 Englisch - English  
 Französisch - French  
 Niederländisch - Dutch

Name .....

Geburtsjahr - Year of birth .....

Strasse, Nr. - Street, no. ....

PLZ, Ort- Postal code, town .....

Telefon/Mail - Phone/Mail .....

**Mein Abonnement beginnt mit der jeweils nächsten Ausgabe.**

**Es läuft nach Erhalt von 4 Heften automatisch weiter, sofern ich nicht rechtzeitig vor Ablauf kündige.**

**Subscriptions normally begin with the next issue. Subscriptions are automatically renewed after 4 issues if not cancelled in time before their expiry.**

**BERNINA International AG, Redaktion Inspiration, CH-8266 Steckborn  
 Fax +41 52 762 13 12, E-Mail: [inspiration@bernina.com](mailto:inspiration@bernina.com)**