

Inspiration 60  
Schnittbogen C  
Modell 6060  
36 - 44

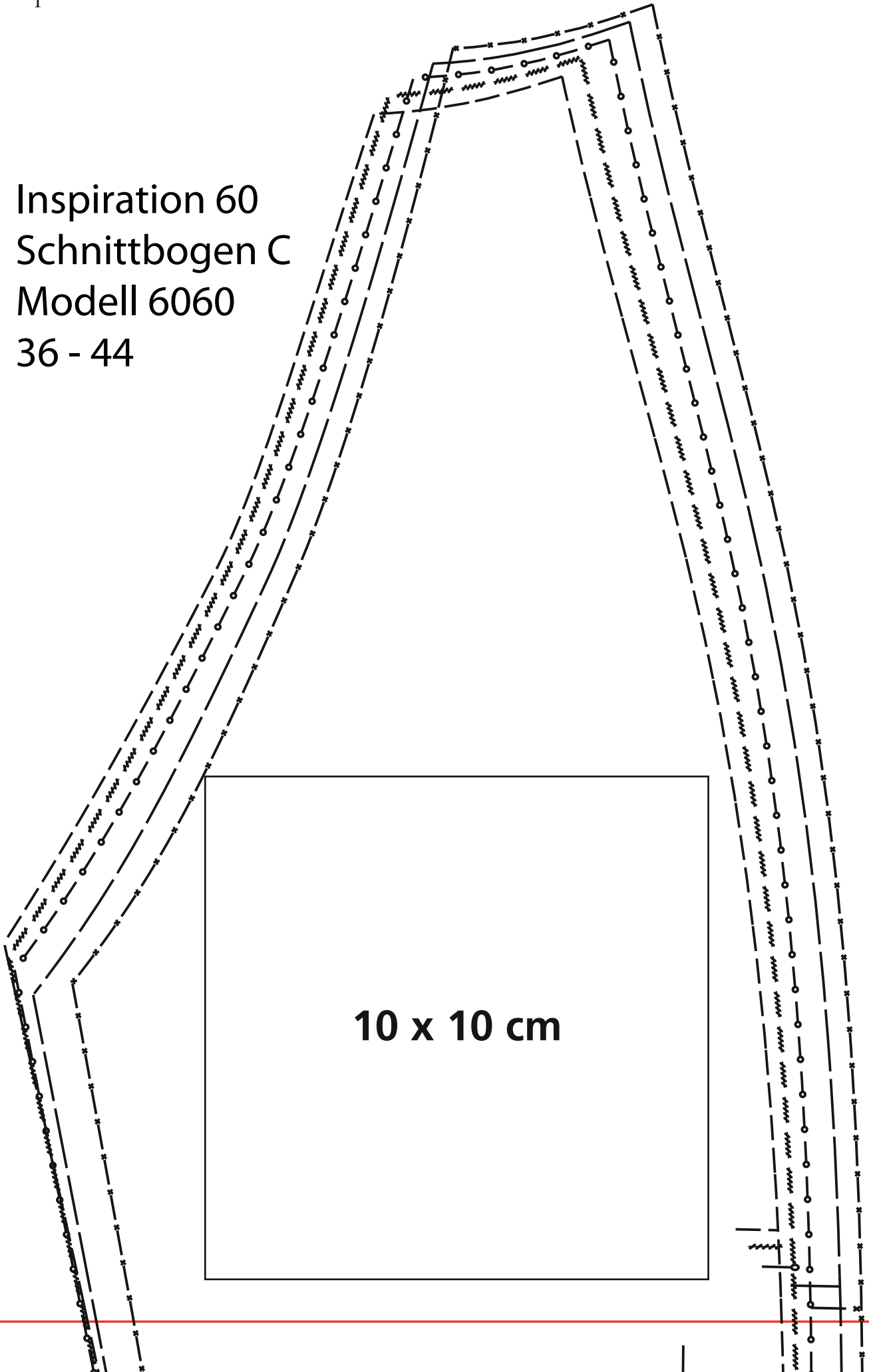

10 x 10 cm

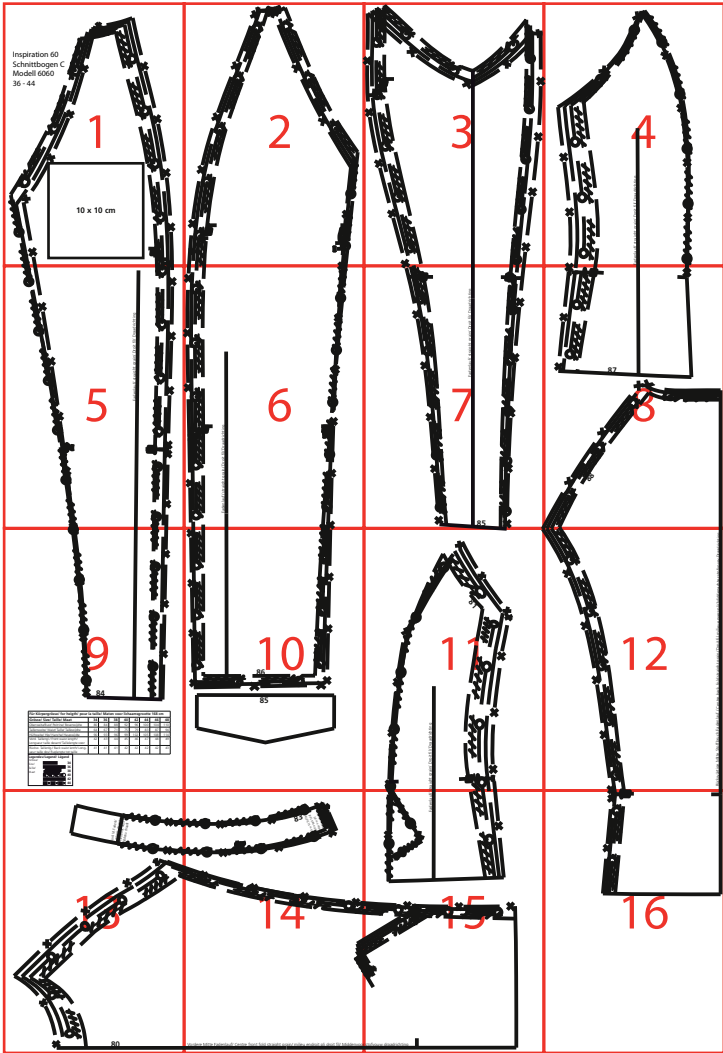
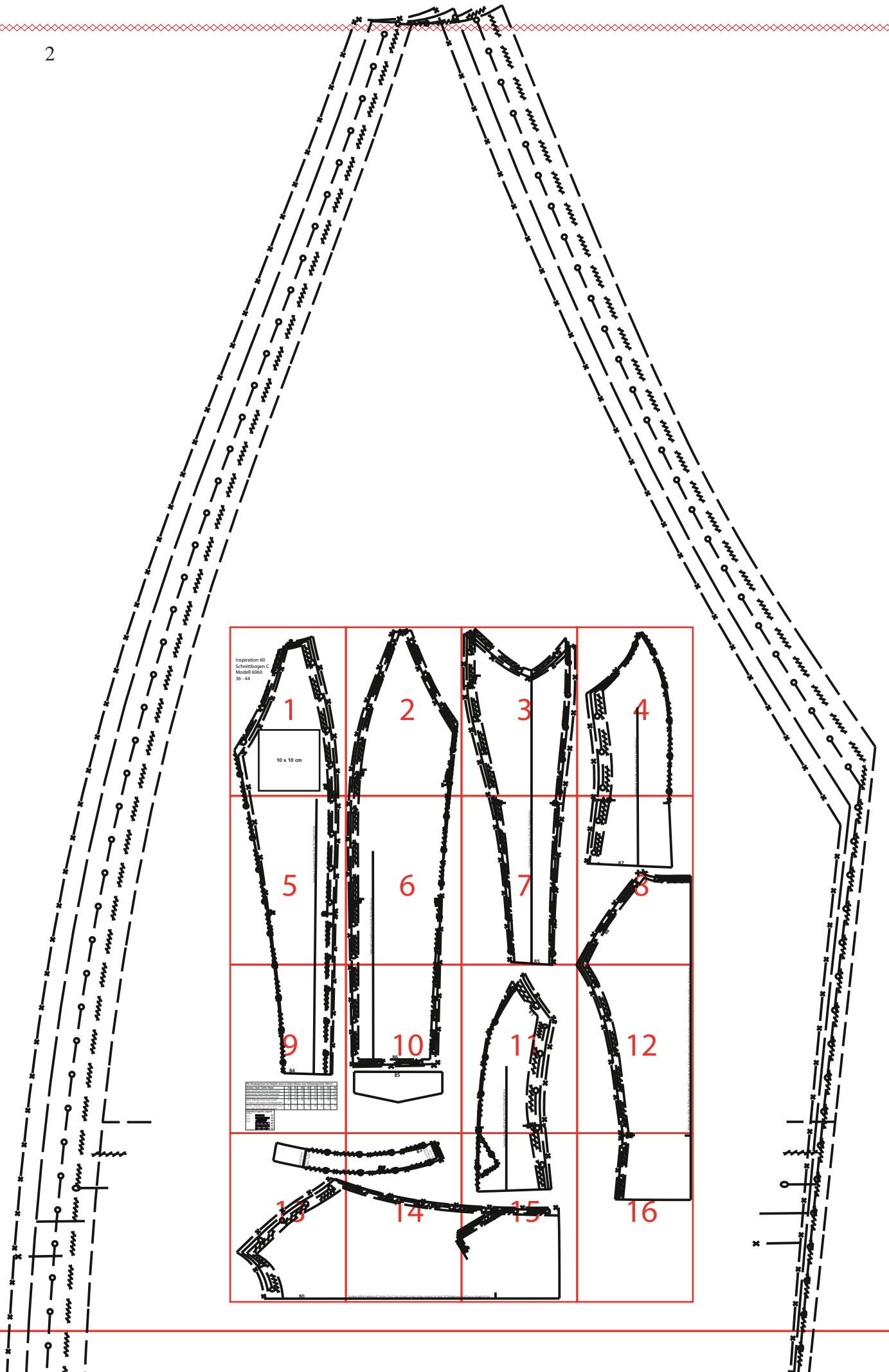

Inspiration 60  
Schreibtischaugen C  
Modell 6050  
36 - 44

10 x 10 cm

1	2	3	4	5	6	7	8	9	10	11	12	13	14	15	16
1	2	3	4	5	6	7	8	9	10	11	12	13	14	15	16
1	2	3	4	5	6	7	8	9	10	11	12	13	14	15	16
1	2	3	4	5	6	7	8	9	10	11	12	13	14	15	16

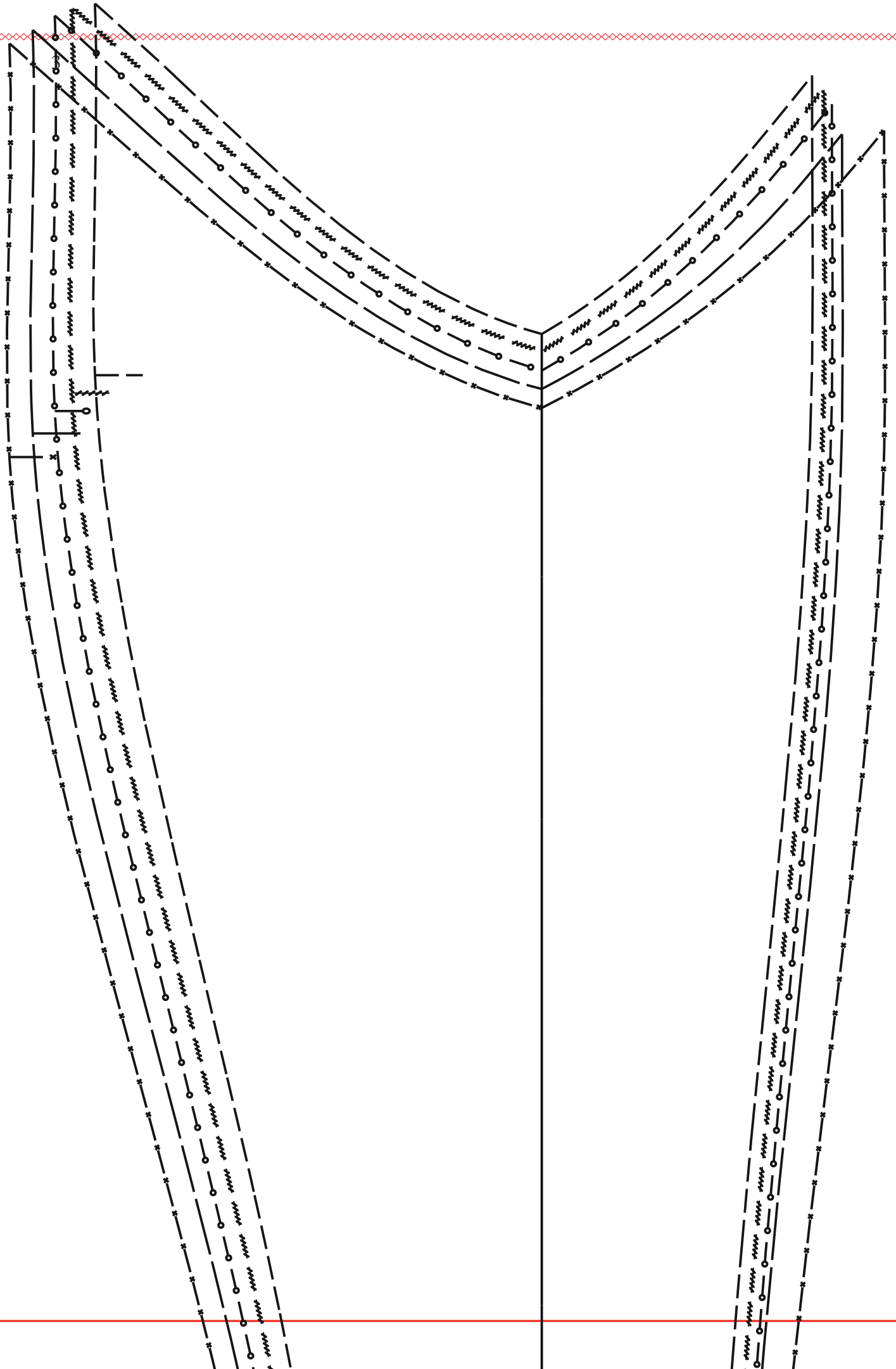

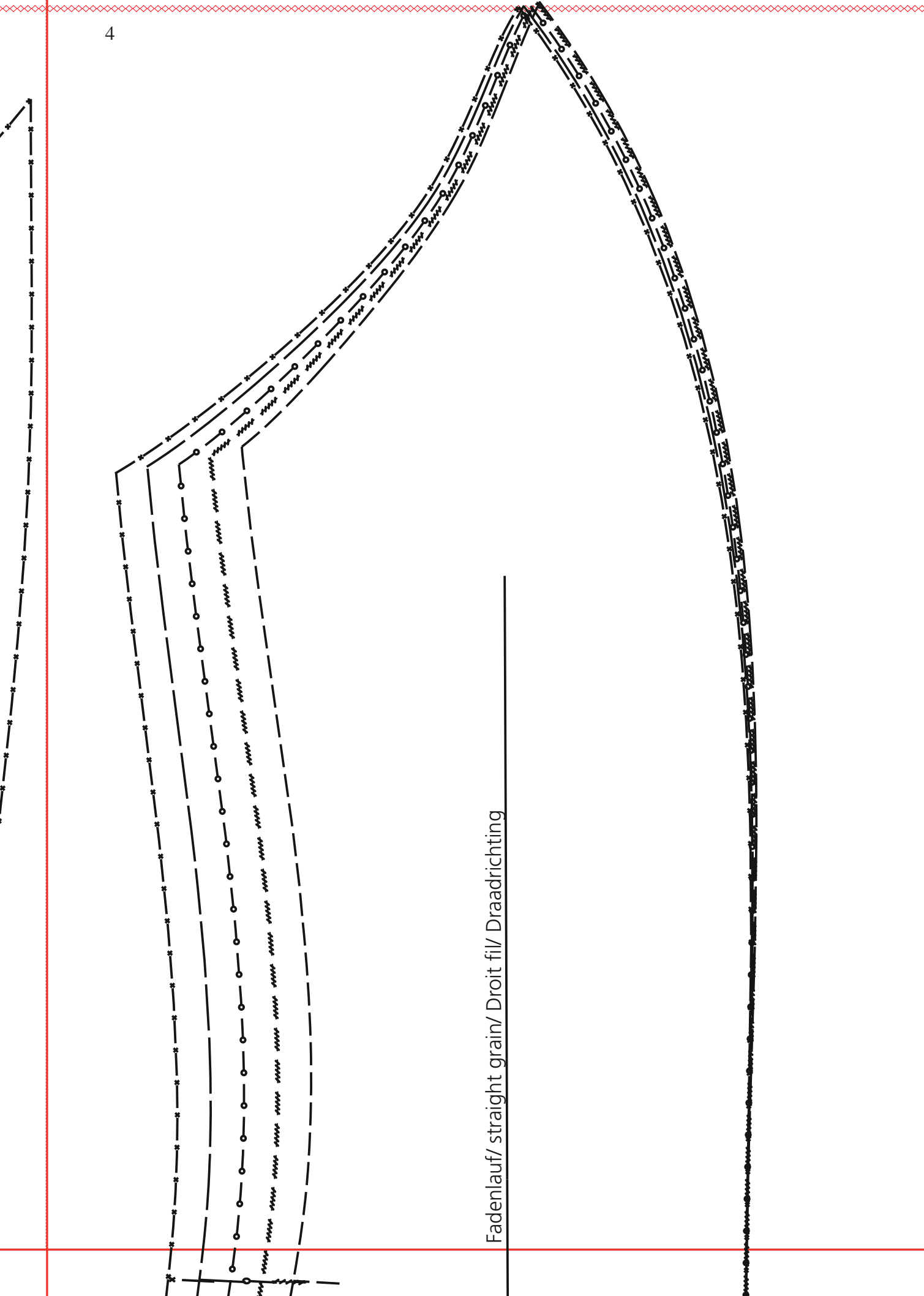

Fadenlauf/ straight grain/ Droit fil/ Draadrichting

5

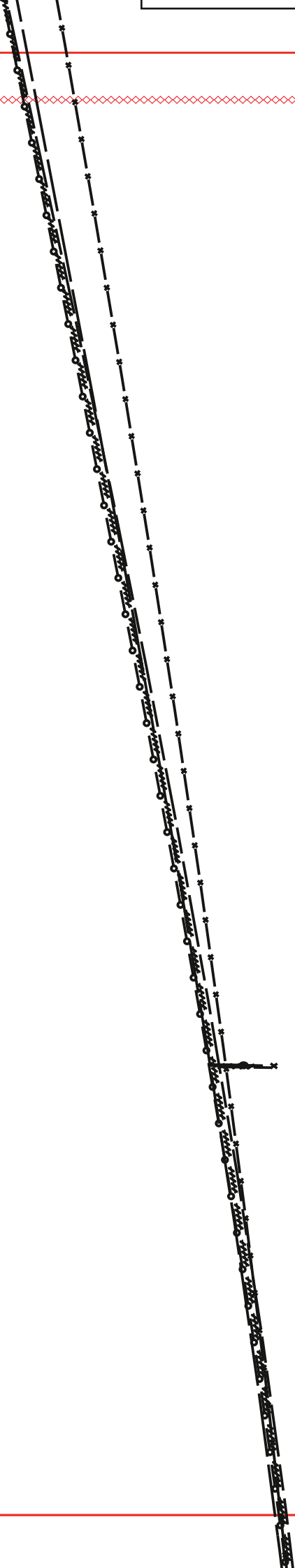

Fadenlauf/ straight grain/ Droit fil/ Draadrichting

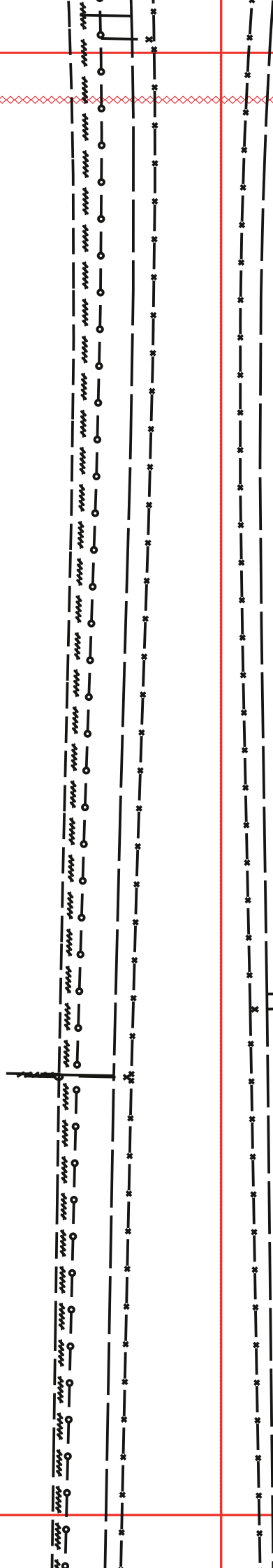

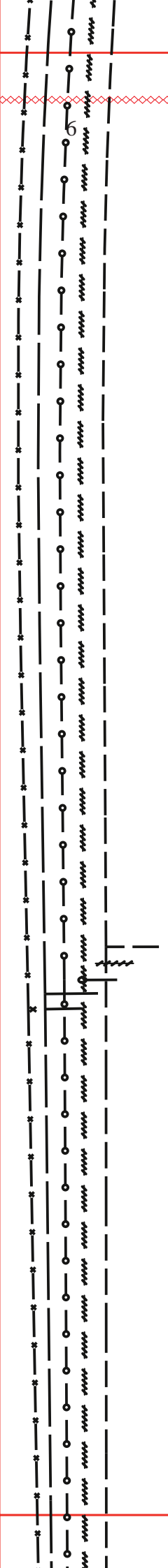

Fadenlauf/ straight grain/ Droit fil/ Draadrichting

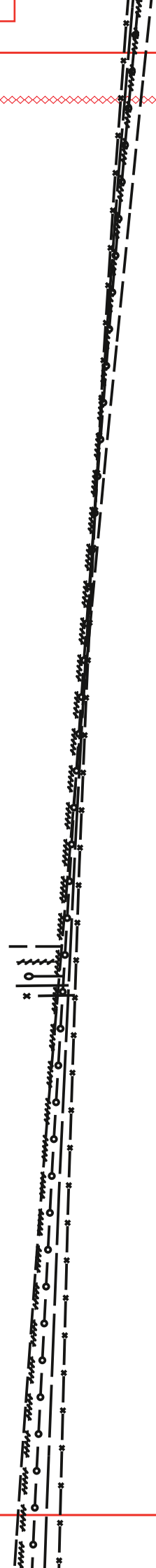

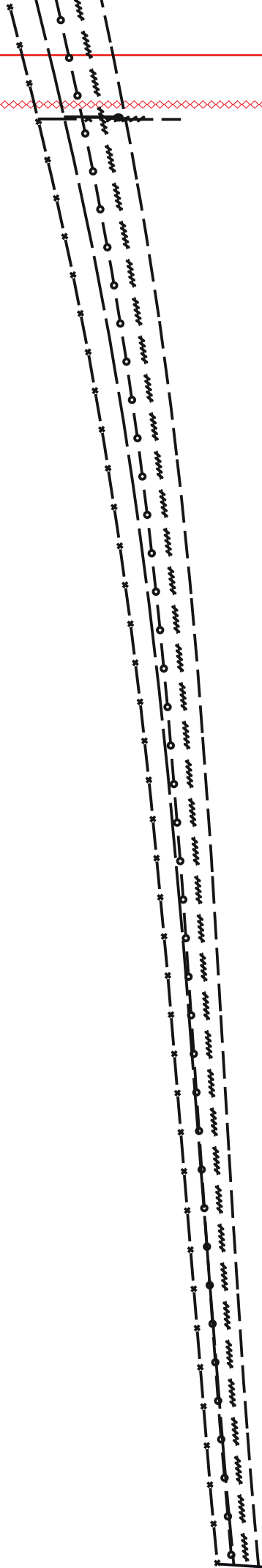

Fadenlauf/ straight grain/ Droit fil/ Draadrichting

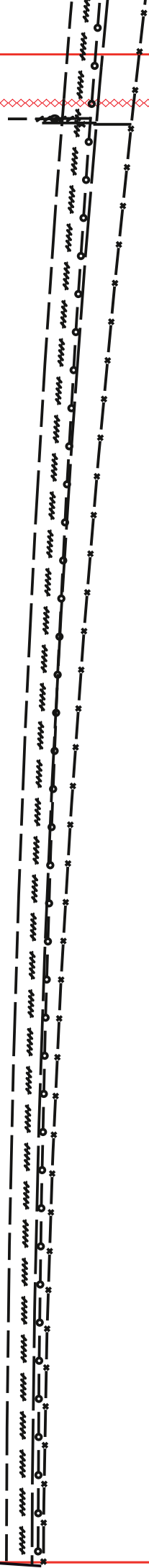

8

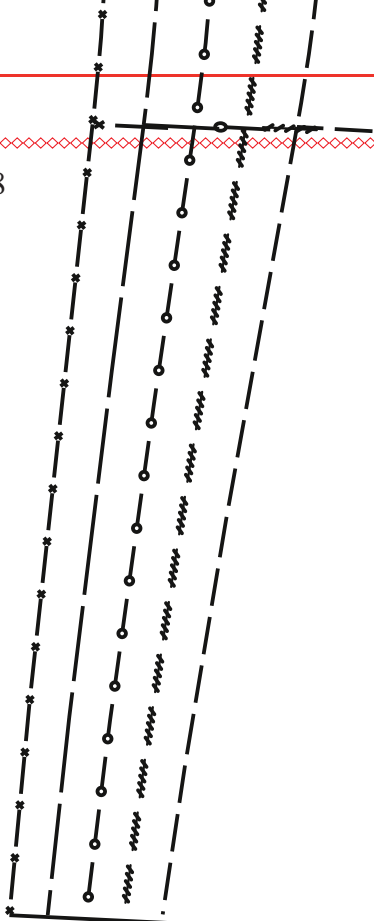

87

Fade

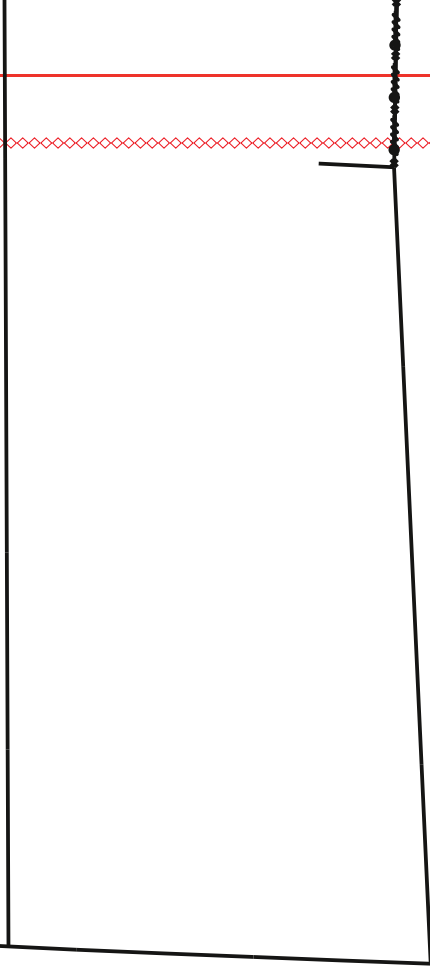

88

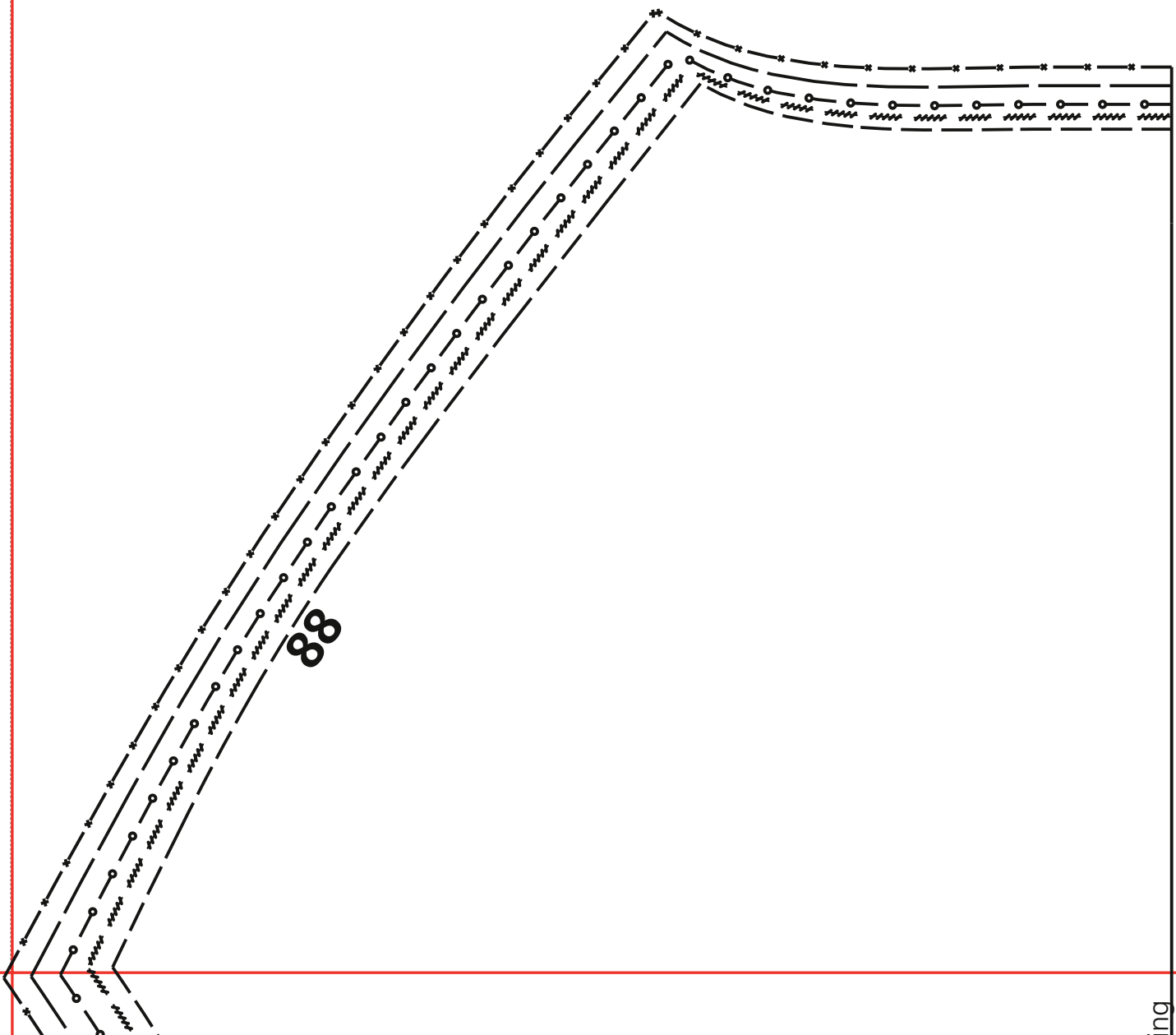



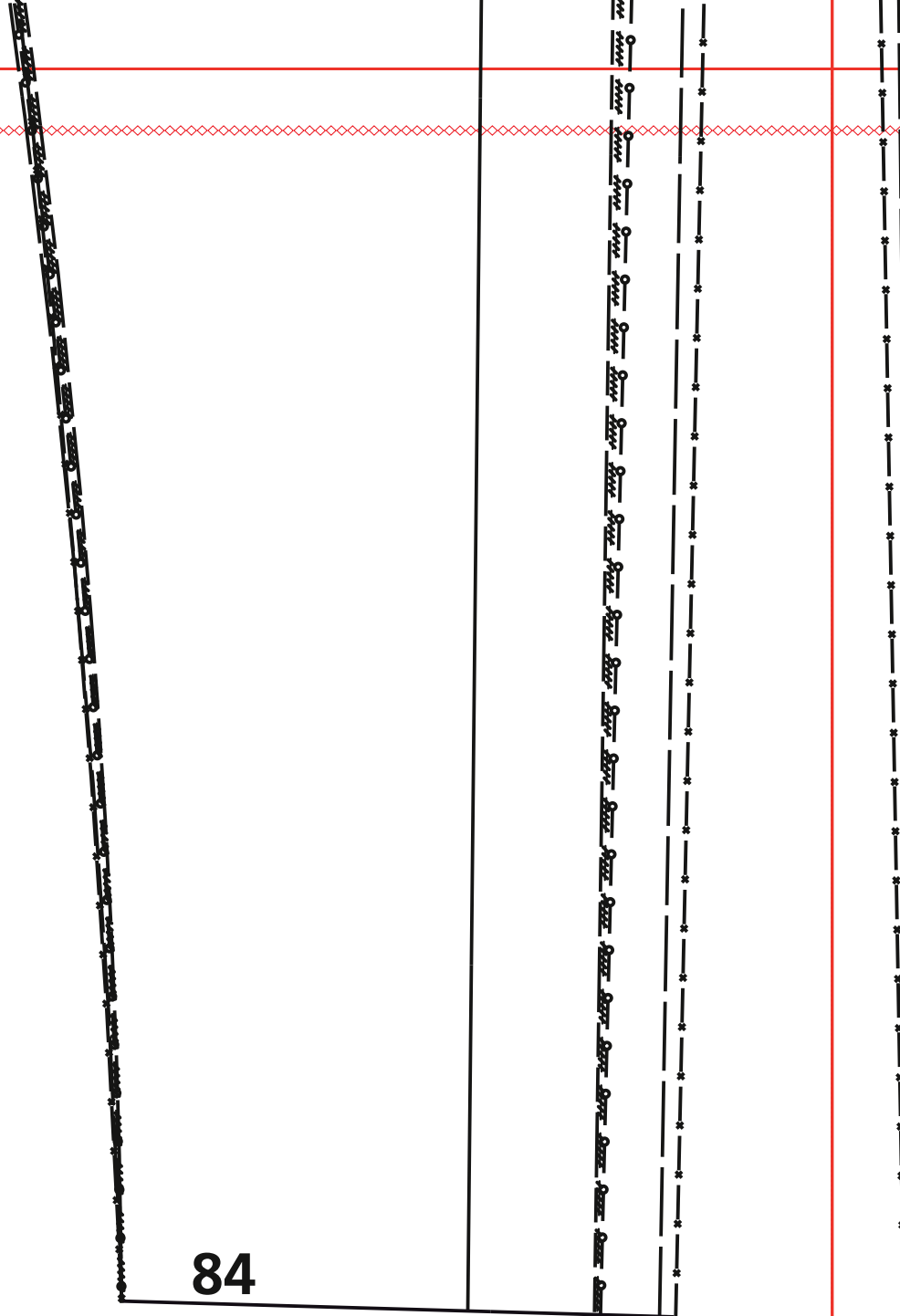

Für Körpergröße/ for heigth/ pour la taille/ Maten voor lichaamsgrootte 168 cm								
Grösse/ Size/ Taille/ Maat	34	36	38	40	42	44	46	48
Oberweite/Bust/ Poitrine/ Bovenwijdte	80	84	88	92	96	100	104	110
Taillenweite/ Waist/ Taille/ Taillewijdte	64	67	71	75	79	83	87	94
Hüftweite/ Hip/ Hanche/ Heupwijdte	90	93	96	99	102	105	108	114
Vord. Taillengl./ Front waist length/ Longueur taille devant/ Taillelengte voor	42	43	44	45	46	47	48	49
Rückw. Taillengl./ Back waist lenth/ Long- ueur taille dos/ Ruglengte tot taille	41	41	41	42	42	42	42	43

**Legende/ Legend/ Légend**

Grösse/	-----	34
Size/	-----	36
Taille/	-----	38
Maat	-----	40
	-----	42
	-----	44

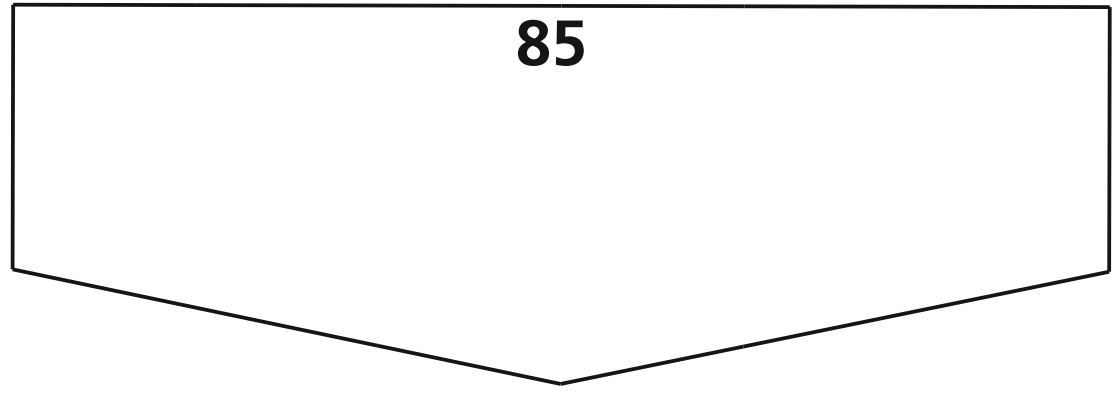
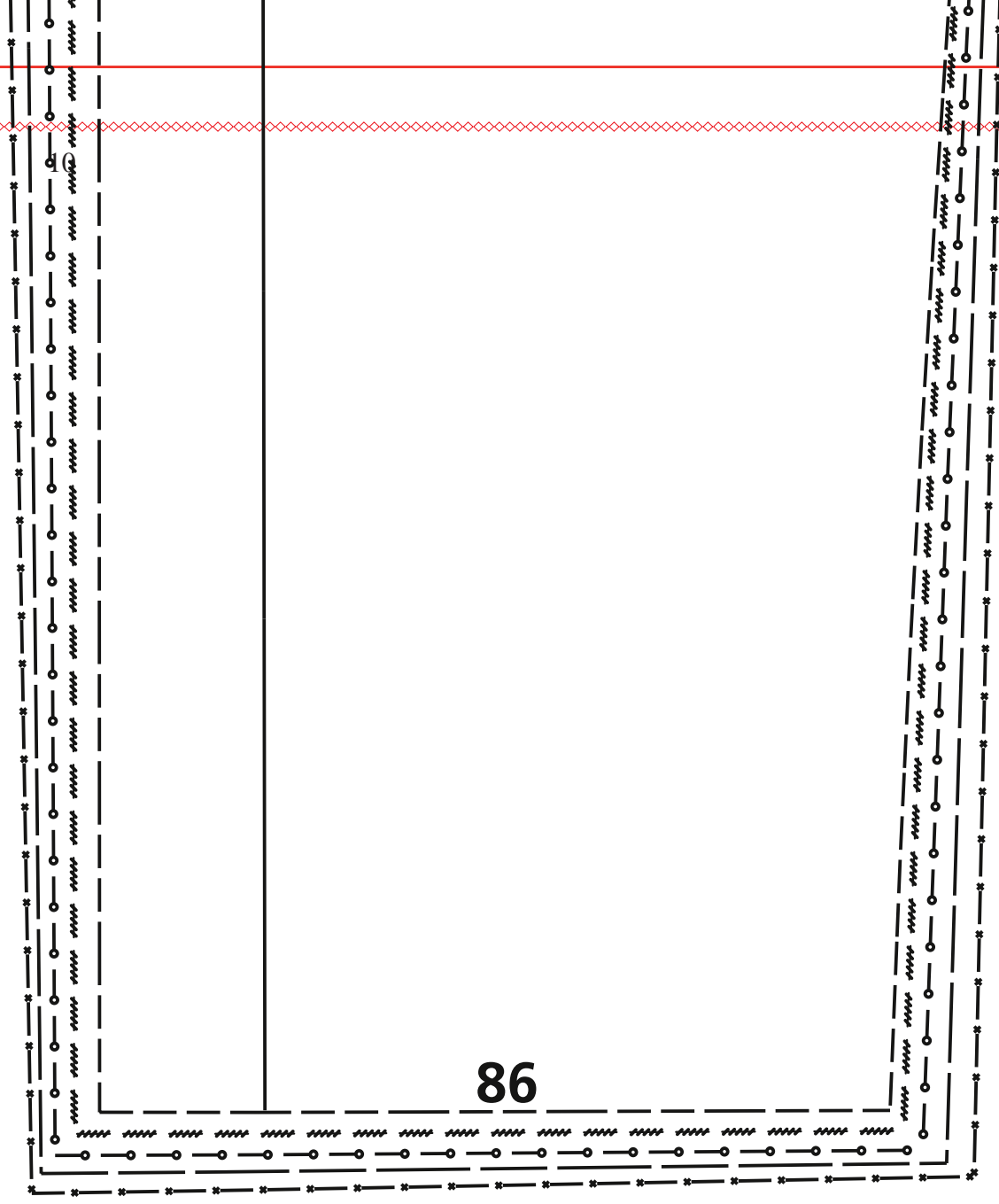

lauf/ straight grain/ Droit fil/ Draadrichting

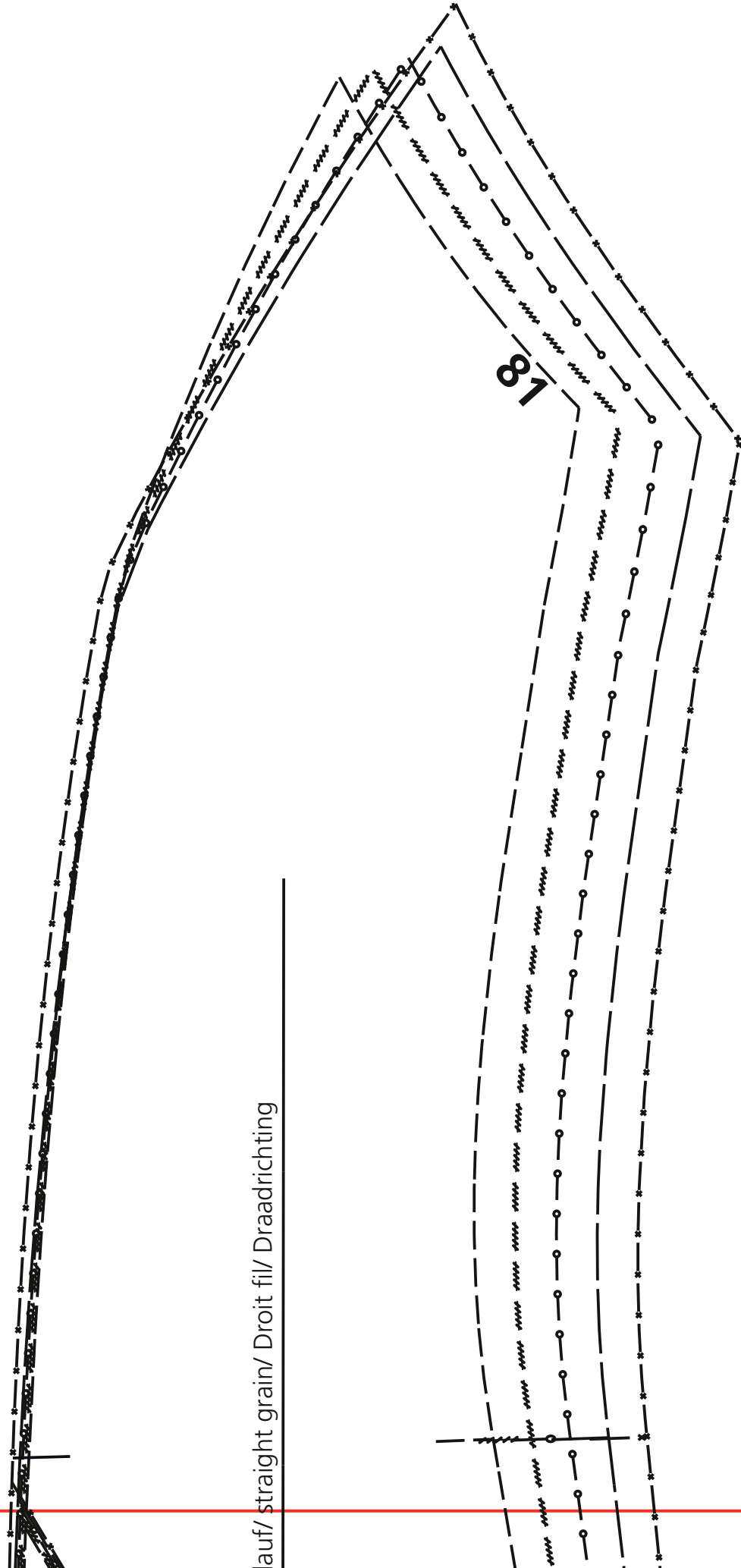

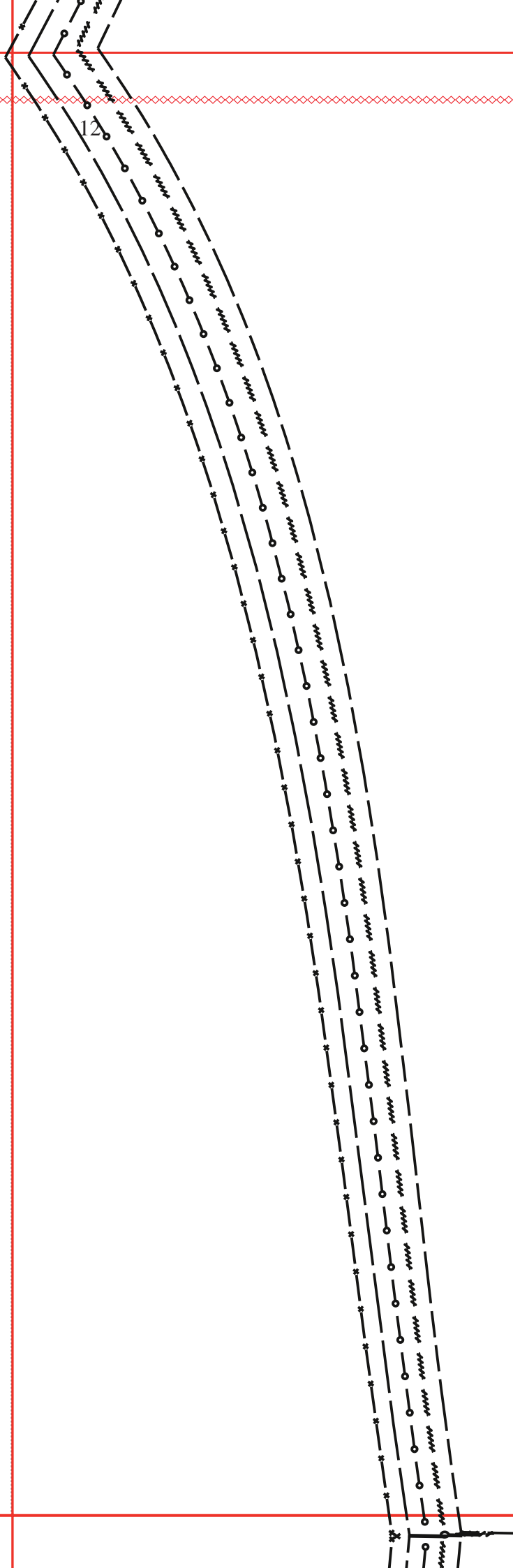

Rückwärtige Mitte Stoffbruch Fadenlauf / Centre back fold straight grain/ Droit fil milieu envers pli/ Middenachter stofvouw Draadrichting

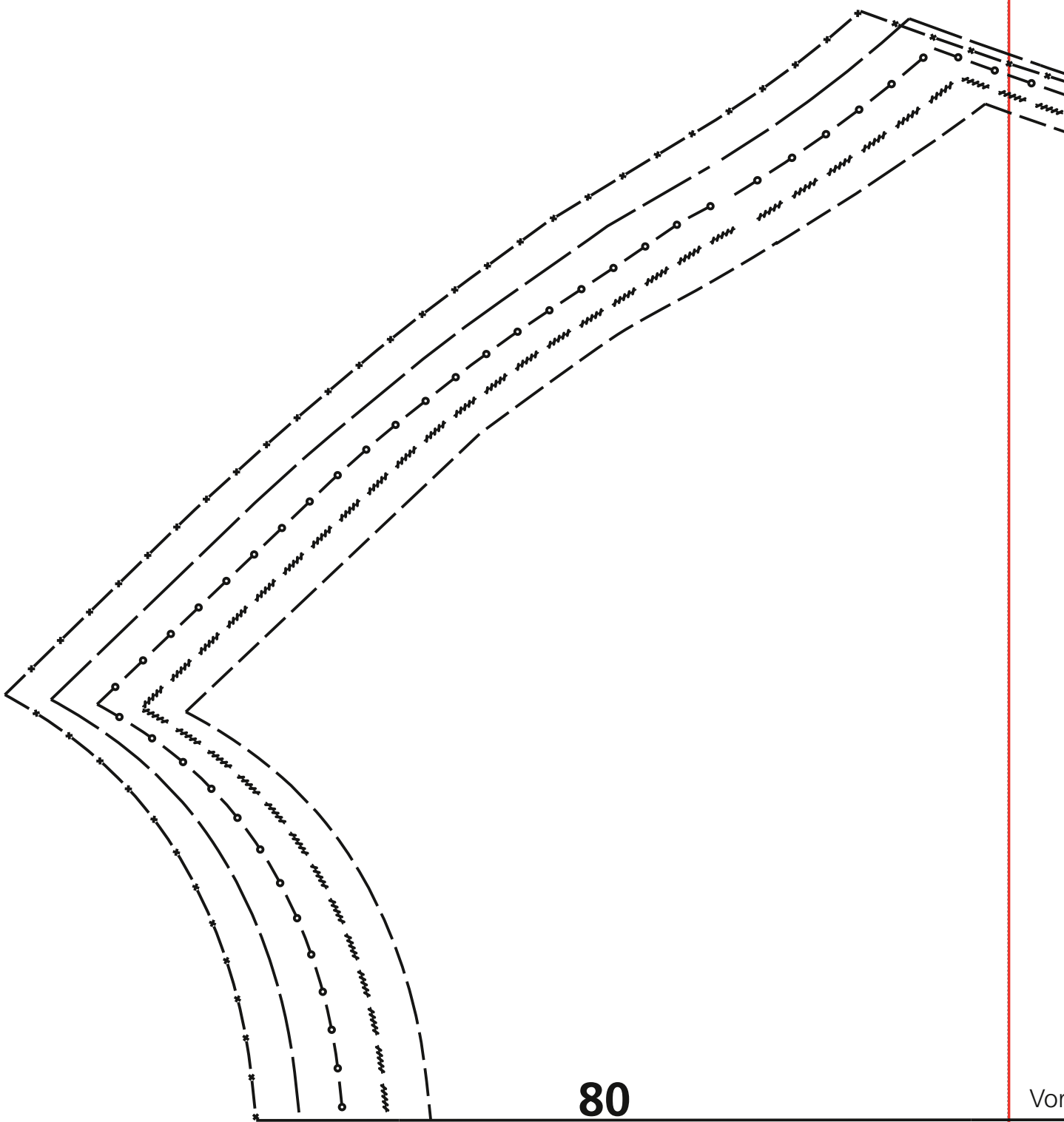
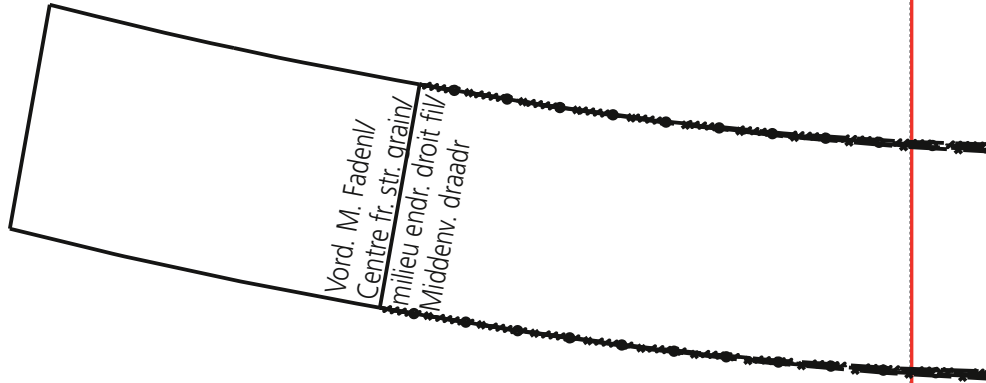

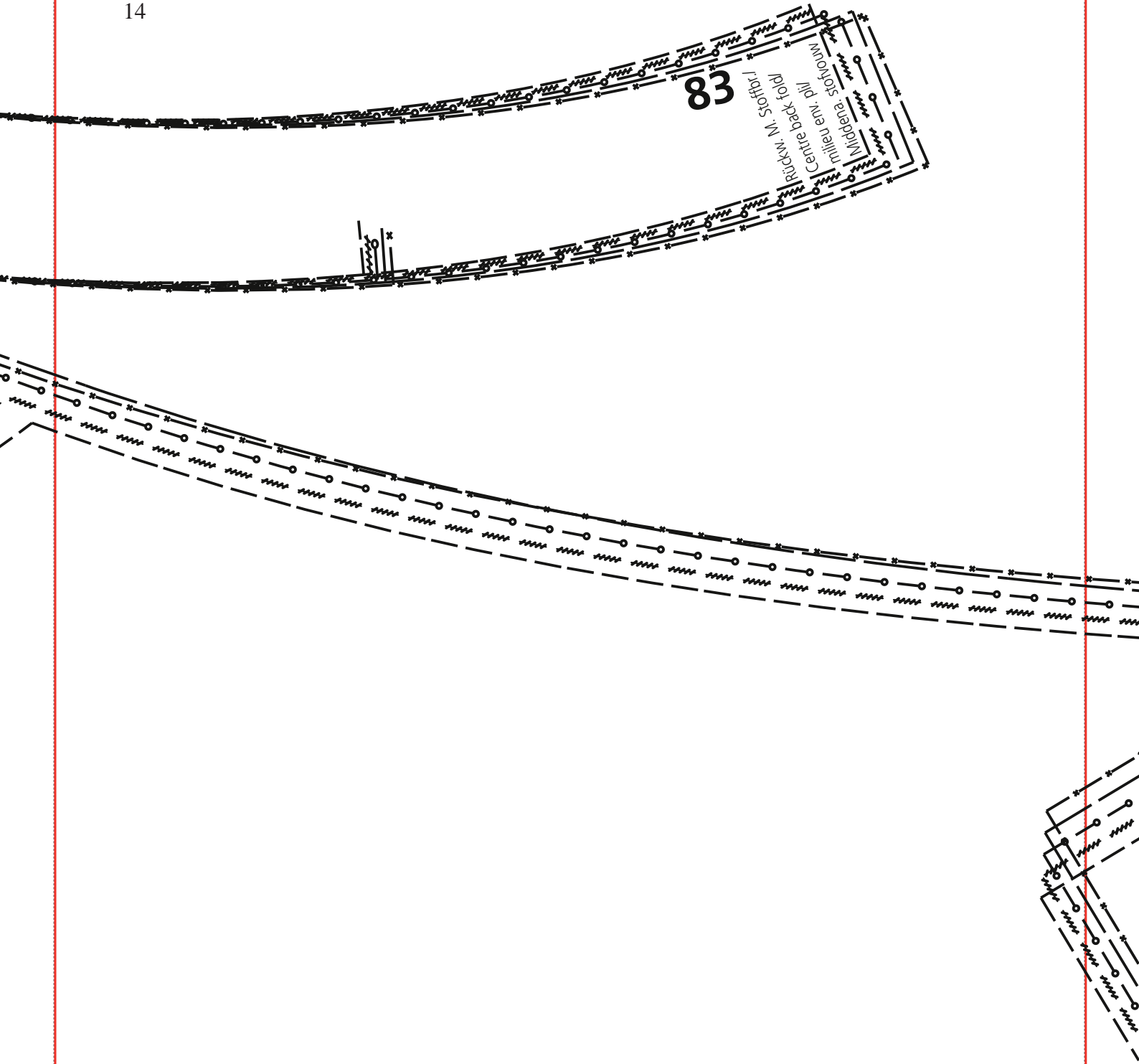

Vordere Mitte Fadenlauf/ Centre front fold straight grain/ milieu endroit pli droit fil/ Middenvoor stofvouw

15

Fadenlauf/ straign

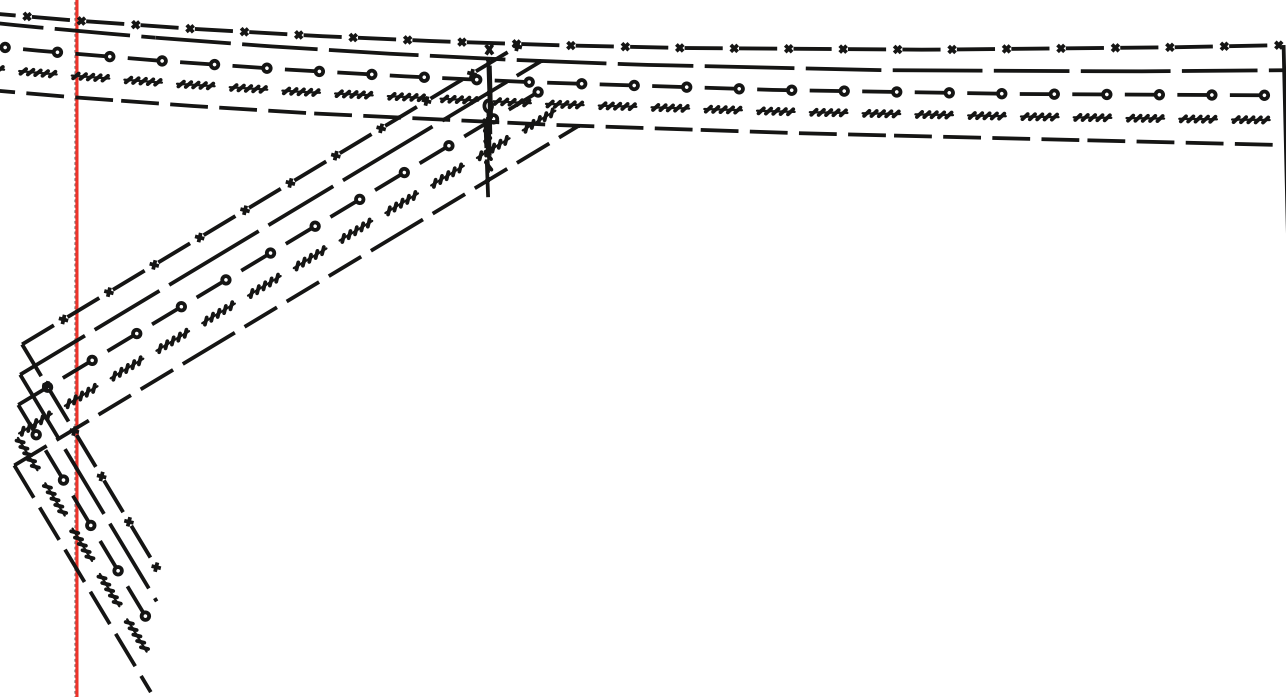
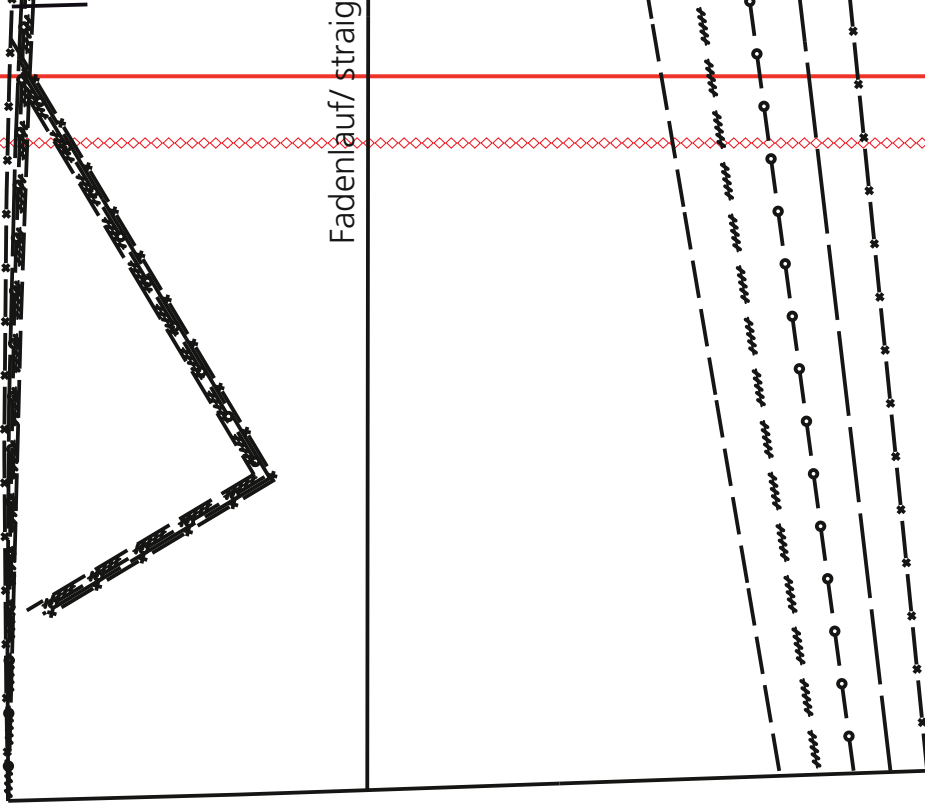

voor stofvouw draadrichting

**4+1-Aktion: Zu Ihrem inspirations-Abo schenken wir Ihnen eine Gratis-Ausgabe!**



**Als Prämie erhalte ich ein Heft gratis, also statt der 4 Ausgaben eines Abonnements erhalte ich 5.**

► ICH ABONNIERE DIE INSPIRATION FÜR 1 JAHR (4 AUSGABEN)

- |      |                                   |         |         |   |
|------|-----------------------------------|---------|---------|---|
| Land | <input type="checkbox"/> Schweiz  | 29 CHF  | Sprache | <input type="checkbox"/> Deutsch        |
|      | <input type="checkbox"/> Europa   | 24 EURO |         | <input type="checkbox"/> Englisch       |
|      | alle Preise inkl. MwSt. und Porto |         |         | <input type="checkbox"/> Französisch    |
|      |                                   |         |         | <input type="checkbox"/> Niederländisch |

Name .....

Geburtsjahr .....

Strasse, Nr. ....

Plz, Ort .....

Telefon .....

E-Mail .....

**Mein Abonnement beginnt mit der nächste inspirations-Ausgabe. Es läuft nach Erhalt von 5 Heften automatisch weiter, sofern ich nicht rechtzeitig vor Ablauf kündige.**

**BERNINA International AG, Redaktion Inspiration, CH-8266 Steckborn  
Fax +41 52 762 13 12, E-Mail: redaktion@bernina.com**