

BERNINA



BERNINA 215

www.bernina.com



BERNINA

**"Welcome to
the BERNINA
family"**

In choosing **BERNINA**, you are assured of years of rewarding sewing. For over 100 years my family has concentrated on providing complete satisfaction to our customers. And it is my personal wish to continue this tradition of offering you Swiss precision engineering combined with state of the art technology and an after sales service second to none.

The new **BERNINA 215** are characterized by a youthful appeal which is combined with a range of added value features to give you, dear Customer, **more sewing pleasure** than ever before. Enjoy modern, creative sewing with **BERNINA**: our wide range of accessories as well as our **sewing publications** brimming with imaginative ideas and practical tips all add to the joy of sewing **BERNINA style**. Any questions you have will be dealt with courteously and efficiently by our highly trained **BERNINA dealers**, who will also be glad to service your sewing computer for you.

H.P. Ueltschi
Owner

www.bernina.com

BERNINA International AG • CH-8266 Steckborn/Switzerland

SAFETY INSTRUCTIONS

IMPORTANT SAFETY INSTRUCTIONS

When using an electrical appliance, basic safety precautions should always be followed, including the following:

Read all instructions before using this sewing computer.

When the sewing computer is not in use, it should be disconnected from the electricity supply by removing the plug from the outlet.

DANGER

To reduce the risk of electrical shock:

1. The sewing computer should never be left unattended when plugged in.
2. Always unplug the sewing computer from

the electrical outlet immediately after using and before cleaning.

3. LED radiation. Do not view directly with optical instruments. LED class 1M

WARNING

To reduce the risk of burns, fire, electric shock or injury to persons:

1. Use the sewing computer only for purposes as described in this manual. Use only attachments/accessory recommended by the manufacturer as contained in this manual.
2. Do not allow the sewing computer to be used as a toy. Close attention is necessary when this sewing computer is used by or near children and infirm persons. This sewing computer is not intended for use by persons (including children) with reduced physical, sensory or mental capabilities, or lack of experience and knowledge, unless they have been given supervision or instruction concerning use of the sewing computer by a person responsible for their safety. Children must be kept under supervision to ensure

-
- that they do not play with the sewing computer.
3. Never operate this sewing computer if:
 - it has a damaged cord or plug
 - it is not working properly
 - it has been dropped or damaged
 - it has fallen into waterTake the sewing computer to the nearest authorized BERNINA dealer for examination, repair, electrical or mechanical adjustment.
 4. Never operate the sewing computer with any air vents blocked. Keep ventilation openings of the sewing computer free from lint, dust and/or fabric bits.
 5. Keep fingers away from all moving parts. Special care is required in the needle area of the sewing computer.
 6. Never drop or insert any objects into any opening on the sewing computer.
 7. Do not use the sewing computer outdoors.
 8. Do not operate the sewing computer where aerosol products (spray) or oxygen is being administered.
 9. Do not pull or push the fabric while stitching. This may deflect the needle, causing it to break.
 10. Do not use bent needles.
 11. Always use the BERNINA original stitch plate. The wrong stitch plate can cause needle breakage.
 12. To disconnect, turn power switch to «0» (off), then remove the plug from the outlet. Do not unplug by pulling the cord, instead grasp the plug to pull it from the outlet.
 13. Turn power switch to «0» (off) when making any adjustments in the needle area, such as changing the needle or the presser foot, etc.
 14. Always unplug the sewing computer from the electrical outlet when carrying out cleaning or maintenance work or any other user servicing adjustments mentioned in this manual.
 15. This sewing computer is provided with double insulation (except USA and Canada). Use only genuine replacement parts. Please note the advice on the servicing of double-insulated products.

SERVICING DOUBLE INSULATED PRODUCTS

In a double-insulated product, two systems of insulation are provided instead of grounding. No grounding means is provided on a double-insulated product nor should a means for grounded be added to the product. Servicing a double-insulated product requires extreme care and knowledge of the system and should only be done by qualified service personnel. Replacement parts for a double-insulated product must be identical to the original parts in the product.

A double insulated product is marked with the words: «Double-Insulation» or «double-insulated».

The symbol  may also be marked on the product.

DISCLAIMER

No liability will be assumed for any possible damage which arises from misuse of this sewing computer.

This sewing computer is intended for household use only. This sewing computer complies with the European Directive 2004/108/EC relating to Electromagnetic Compatibility (EMC).

SAVE THESE INSTRUCTIONS!

Note:

Please find the latest version of your instruction manual at **www.bernina.com**



Environmental Protection

BERNINA is committed to the protection of the environment. We strive to minimize the environmental impact of our products by continuously improving product design and our technology of manufacturing.

At end of life please dispose this product in an environmentally responsible way according to the national directive. Do not throw away this product with your household waste. In case of doubt, please contact your dealer.

Important safety Instructions	2
Details of the sewing computer	6
Standard Accessories	8
Feet selection	9
Optional Accessories	10
Setting up the sewing computer	12
Operating instructions	20
Stitch overview	23
Selected practical stitches	24
Sewing Needles	31
Maintenance	33
Troubleshooting	34
Index	35

Details of the sewing computer



Front view



Right end

- | | | | |
|----|-----------------------------------------|----|-----------------------------------|
| 1 | Bobbin cover | 20 | Stitch length button |
| 2 | Stitch plate | 21 | clr/del-button |
| 3 | Attachment base for special accessories | 22 | Stitch selection buttons |
| 4 | Sewing table socket | 23 | Handwheel |
| 5 | Presser foot shaft | 24 | Balance adjustment |
| 6 | Needle clamp with fixation screw | 25 | Power switch on/off |
| 7 | Needle Threader | 26 | Power plug socket |
| 8 | Thread guide | 27 | Drop feed-dog |
| 9 | Reverse button | 28 | Foot control socket |
| 10 | Thread take up cover | 29 | Spool pin (vertical, collapsible) |
| 11 | Thread path | 30 | Carrying handle |
| 12 | Bobbin pre-tension | 31 | Horizontal spool pin |
| 13 | Thread tension adjustment | 32 | Rear thread guide |
| 14 | LCD display | 33 | Accessory box connection |
| 15 | Needle stop up/down | 34 | Presser foot lifter (manual) |
| 16 | 1/2 motor speed | 35 | Thread cutter |
| 17 | Bobbin winder | | |
| 18 | Stitch width button | | |
| 19 | Needle position button | | |



Back view

Accessories



- Fabric cover
- Accessory case
- 2 bobbins (one of them in the bobbin case)
- Presser feet shaft with 5 soles
- Selection of 130/705H needles
- Seam ripper
- Lint brush
- 3 spool discs
- Foam pad
- Oiler
- Foot control
- Power cable
- Angular Torx button
- Warranty card

Power cable

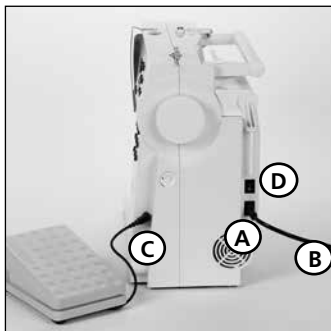

The power cable

- plug **A** into sewing computer
- plug **B** into wall socket

Foot control cable

- plug **C** into sewing computer

Power switch (D)

1 the computer is switched on
0 the computer is switched off
 The sewing light is switched on and off with the power switch.

Foot control



The foot control regulates the sewing speed

Sewing speed is adjusted by applying more or less pressure to the foot control.

Important! (USA/Canada only)

Use only foot controller type SR-1 with sewing computer B215.

Self storing cord

- wind the cord on the reel
- insert the plug into the groove provided



When sewing

- unwind the cable



Refer to the safety instruction!

Important! (USA/Canada only)

This sewing computer has a polarized plug (one blade wider than the other). To reduce the risk of electric shock, this plug is intended to fit in a polarized outlet only one way. If the plug

does not fit fully in the outlet, reverse the plug. If it still does not fit, contact a qualified electrician to install the proper outlet. Do not modify the plug in any way.

Standard snap-on soles



Presser foot shaft
for snap-on soles



1 Reverse pattern sole
for practical and decorative stitches



2 Overlock sole
Overlock seams, hems, over-sewing edges, narrow satin stitches



3 Buttonhole sole
for manual buttonholes



4 Zipper sole
for sewing in zippers



5 Blind stitch sole
Blind hems, edge stitching

Note that all presser feet are available as stable feet as well.

Sewing table



To attach

- raise the needle and presser foot
- place the table over the free arm and press firmly so that it engages on the fixing cam

To remove

- raise the needle and presser foot
- pull the table out of the fixing cam
- pull in a horizontal position to the left

Scale of sewing table

- «0» corresponds to the centre needle position

Seam guide for sewing table

- insert into the groove (underside of table) from the right or left
 - it can be freely adjust over the whole width of the table
- Note:** Remove the presser foot or the presser foot shaft when attaching the seam guide!

Lens Set



We recommend the use of the BERNINA Lens Set for more comfort when sewing.

Foot Control

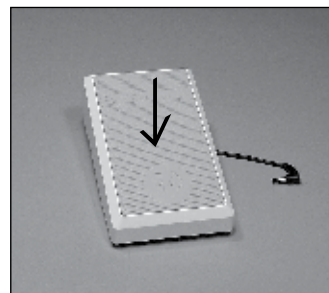

Sewing speed

- control the sewing speed by depressing the foot control
- raise or lower the needle by tapping on the foot control with your heel

Start-stop-unit

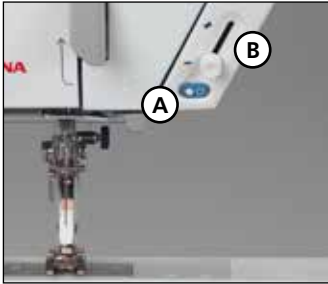

With the Start-stop-unit (SSU) the start-stop-function can be controlled by hand.

- press start-stop-button **A** = stitching starts
- with the speed regulator **B** the sewing speed can be regulated by hand
- to interrupt or stop sewing = press start-stop-button **A** again

Note:

If the foot control is connected with the sewing computer, the Start-stop-unit is deactivated.

LED Sewing Light



Please refer to the safety instructions!

The LED sewing light illuminates the sewing area and has a long product life.

Attention:

Please note that a defective sewing light must **ONLY** be replaced by an authorized technician.

The sewing computer must be taken to an authorized BERNINA dealer!

Winding the bobbin

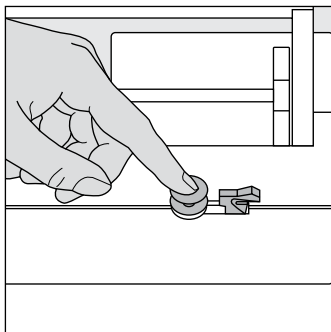

Winding the bobbin

- turn power switch on
- place empty bobbin on spindle

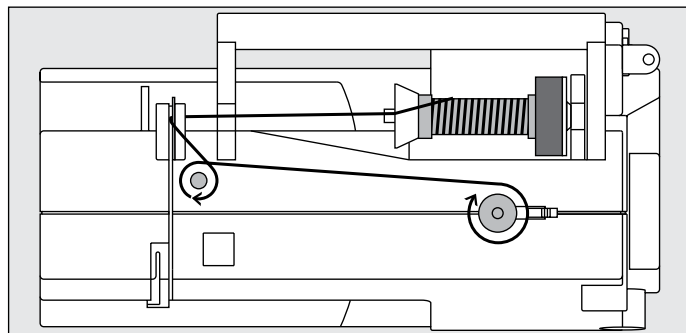

- following the direction of the arrow take thread through the rear guide and round the pre-tension stud
- wind the thread two to three times around the empty bobbin and cut off any excess thread on the thread cutter
- press the engaging lever against the bobbin
- press the foot control
- the motor will stop automatically when the bobbin is full
- remove the bobbin

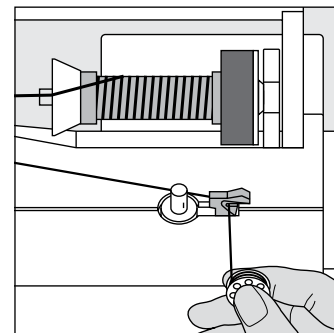

Thread cutter

- cut the thread on the thread cutter

Note:

When winding the bobbin on the vertical spool holder (p. 15), it may be necessary to adjust the speed.

Bobbin case

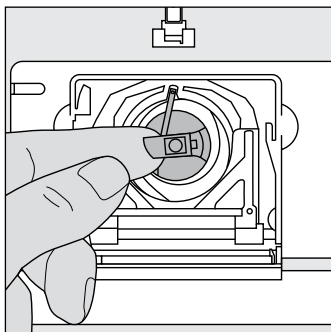

To remove the bobbin case

- raise the needle
- turn power switch to «0»
- open the bobbin cover
- grasp the latch of the bobbin case
- remove case

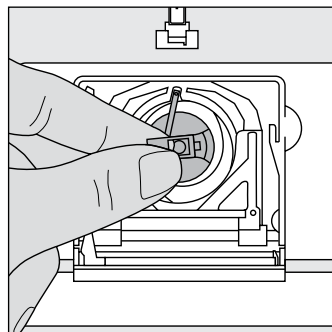

To insert the bobbin case

- hold the bobbin case latch
- the finger on the case should point upwards
- insert so that it clicks into place

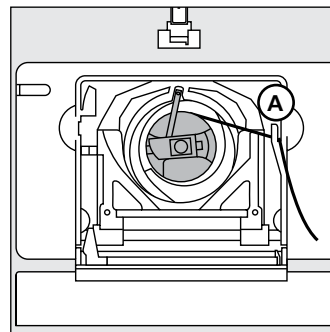

Bobbin thread cutter

- insert the bobbin case
- take the thread over cutter **A**
- thread is cut
- close the bobbin cover

Note:

The bobbin thread does not have to be brought up as the loose end is just the right length to start sewing.



Please refer to the safety instruction!

Inserting the bobbin

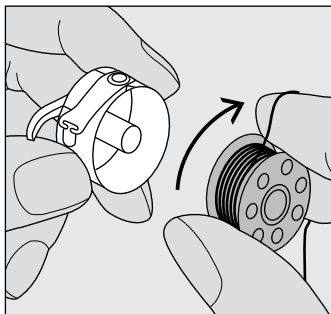

Insert the bobbin

Insert the bobbin so that the thread runs clockwise.

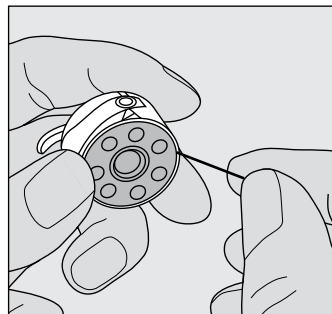

Pull the thread counter clockwise into the slot.

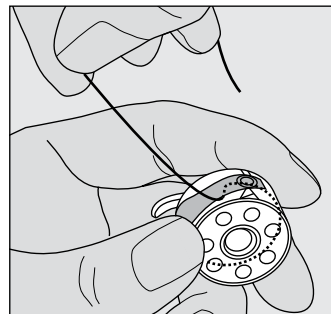

Pull the thread to the left under the spring until ...

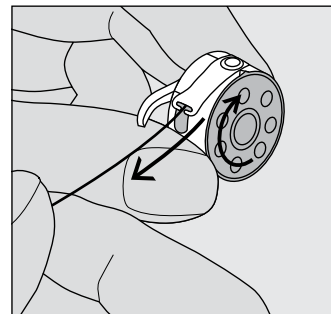

... it lies in the T-shaped slit at the end of the spring.
The bobbin must turn clockwise when thread is pulled.

Changing the needle

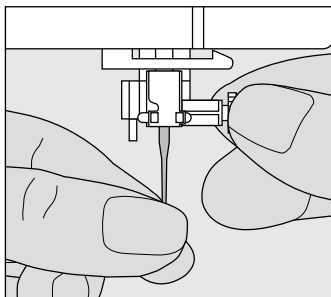

Removing the needle

- raise the needle
- turn power switch to «0»
- lower the presser foot
- loosen the needle clamp screw
- pull the needle down to remove

Inserting the needle

- flat side of needle to the back
- insert the needle as far as it will go
- tighten the needle clamp screw



Please refer to the safety instruction!

Changing the presser foot sole

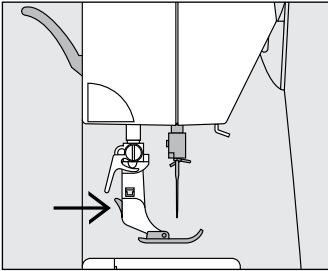

Changing the presser foot sole

- raise the needle and the presser foot shaft
- turn power switch to «0»
- press the button on the shaft to release the sole

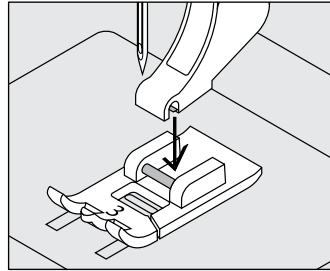

Attaching the presser foot sole

- place the presser foot sole under the shaft so that the peg sits under the opening of the shaft

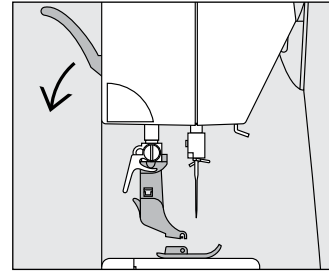

- lower the presser foot lifter and the foot sole will click into position



Please refer to the safety instruction!

Supplementary spool pin

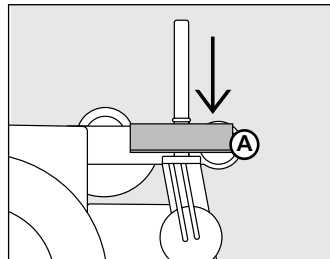
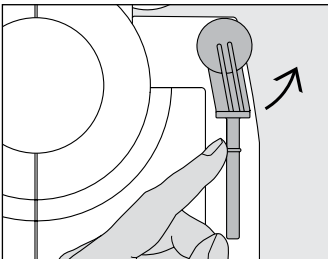

Collapsible vertical spool pin

- found on the back of the sewing computer behind the handwheel
- essential aid for sewing with more than one thread, i.e. double needle work
- raise the pin until it clicks into its vertical position
- when using large reels, add the foam pad **A** for stability

Threading the upper thread

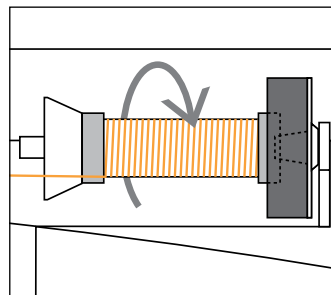
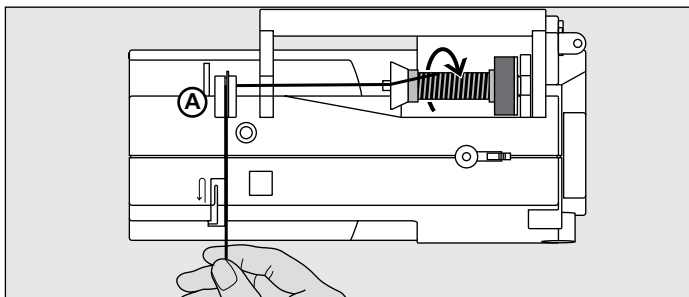

Attaching the thread spool

- raise the needle and the presser foot
- switch the power off
- attach the foam pad
- place spool on pin (thread unwinds clockwise)
- attach the appropriate spool disc - diameter of spool disc is disc size. There must be no clearance between the disc and the spool
- take thread through rear guide **A**
- then into slit of upper thread tension
- pull thread down to the right of the take-up cover to **B**
- take thread up to the left of the cover to **C** in the direction of the arrow, placing it in the take-up level
- take thread down and through guides **D** and **E**

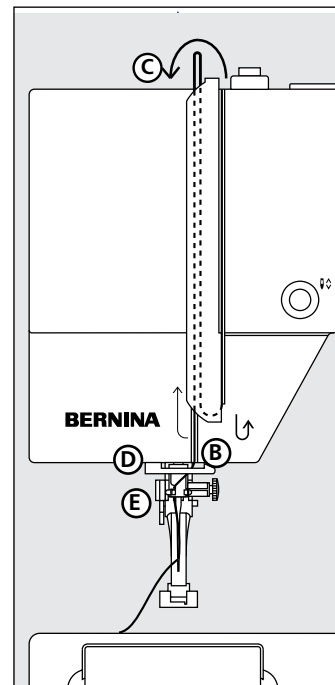

Please refer to the safety instruction!

Needle Threader

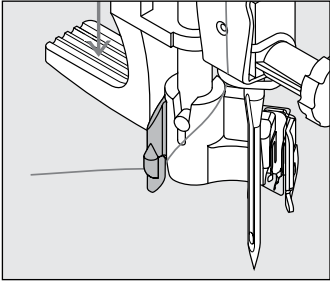

Thread in hook

- raise the needle
- lower the presser foot
- lay the thread behind hook **B** and hold lightly

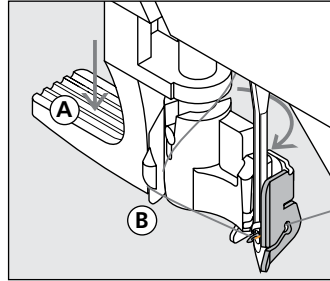

Lever down

- press lever **A** down and simultaneously guide the thread around hook **B** to the right to the needle

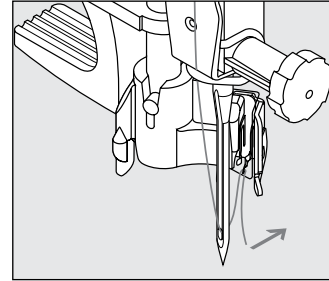

Thread in front of needle

- put the thread from the front into the guide until it catches in the hook
- let go of lever **A** and thread

Thread cutter

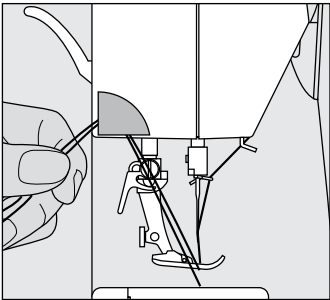

Thread cutter on head frame

- pull both threads from front to back over the cutter
- the threads release as soon as the first stitch is sewn

Stitch plate

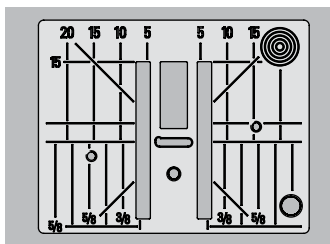

Note: To change the stitch plate see page 33

Stitch plate markings

- the stitch plate is marked with vertical, horizontal and diagonal lines in mm and inches
- the lines help to guide the fabric for sewing seams and precise topstitching, etc.
- the horizontal markings are helpful for sewing corners and buttonholes, etc.
- the diagonal markings are useful for quilting
- the vertical measurements correspond to the distance between the needle and the line
- needle insertion point is position «0» (center needle position)
- the measurements are marked to the right and left, measuring from the center needle position

Feed-dog and fabric feed

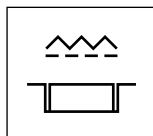
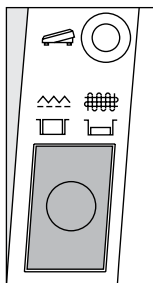

Button flush with housing = sewing position

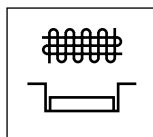

Button depressed = feed-dog is lowered
 • for free-hand sewing or darning

Feed-dog and stitch length

With each stitch the feed-dog moves forward by one step. The length of this step is determined by the stitch length selected. With an extremely short stitch length, the steps are also short. The fabric moves under the foot quite slowly, even at full sewing speed. Buttonholes are sewn with a very short stitch length.

Thread tension

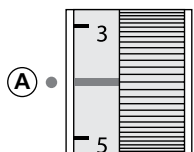

The basic setting

- is indicated when the red line on the tension adjustment wheel is in line with the marking **A**
- the tension does not need adjusting for normal sewing work
- for special sewing work, the tension can be adjusted to suit the fabric

The tension is factory set for the best results.

Metrosene 100/2 (Arova Mettler, Switzerland) is used to set both the upper and lower thread tension.

If other sewing or embroidery threads are used, the tension may need adjusting to suit the fabric and chosen stitch.



Perfect stitch formation

- the stitch formation is in the fabric



Upper thread tension too tight

- the lower thread is pulled more to the right side of the fabric
- to reduce the upper thread tension turn tension adjustment wheel to 3–1



Upper thread tension too loose

- the upper thread is pulled more to the wrong side of the fabric
- to increase the upper thread tension turn tension adjustment wheel to 5–10

For example:

	Tension
Metallic thread	approx. 3
Monofilament	approx. 2–4

Balance

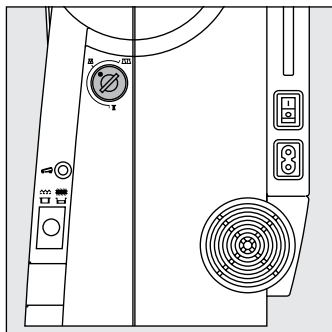

Your sewing computer has been tested and factory set using a double layer of cretonne fabric and Metrosene 100/2 threads (Arova Mettler, Switzerland).

Different fabrics, threads and stabilizers can naturally affect the stitch balance so that they are sewn too close together or not close enough.

This can be remedied with Balance to suit the fabric and produce perfect results.

Applications:
Practical stitches, e.g. Honeycomb stitch on jersey, buttonholes, etc.

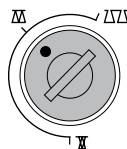

Normal position

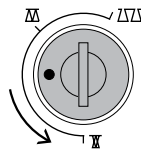

Denser stitch formation
(shorter stitch length)

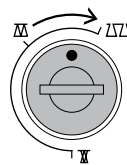

Finer stitch formation
(longer stitch length)

Note:
If the balance has been adjusted, return it to the normal setting once sewing is completed.

LCD Display

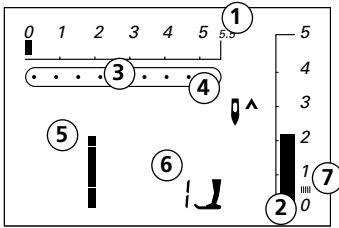

The LCD display shows

- 1 stitch width, basic setting blinks constantly
- 2 stitch length, basic setting blinks constantly
- 3 needle position (9 positions)
- 4 needle stop up/down
- 5 stitch number
- 6 recommended foot for selected stitch
- 7 satin stitch; dense, short zig-zag stitch

Altered Stitch Memory

- any stitch length or width alterations will be saved automatically
- For example:
- sew altered stitch, e.g. zig-zag
 - select another stitch, e.g. straight stitch
 - return to zig-zag, your alterations are still active

Buttons

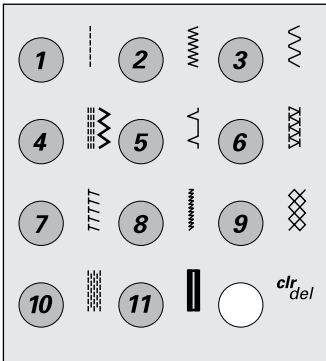

Stitch selection

- stitches 1–11: touch the number of your choice; stitch number and basic width and length settings appear on the LCD display

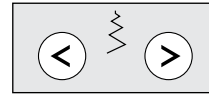

Stitch width

- left button = narrow the stitch width
- right button = widen the stitch width
- the basic settings of the chosen stitch blink constantly

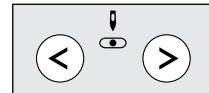

Needle position

- left button = needle to the left
- right button = needle to the right

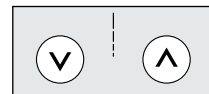

Stitch length

- left button = shorten the stitch length
- right button = increase the stitch length

Functions

Functions are ...

activated when the symbol appears on the LCD display.

deactivated when the symbol no longer appears on the LCD display.

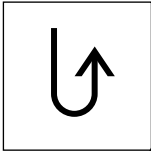

Reverse sewing

quick reverse:

- press button
- Sewing computer sews reverse until button is released (max. stitch length 3 mm)

Applications:

- programming buttonholes
- programming darning program
- manual securing (seam begin and end)

continous reverse:

- press button quickly twice
- the sewing computer sews the chosen stitch in reverse
- press button once to cancel

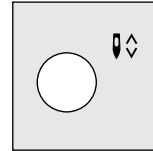

Needle stop

- basic setting needle stop up
- press button
- arrow points down = sewing computer stops with needle down
- press button again
- arrow points up = sewing computer stops with needle up

Note:

Press button a bit longer = the needle will go automatically up or down.

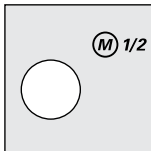

1/2 motor speed

- press the button and the sewing speed will be halved
- press the button again to revert to full speed

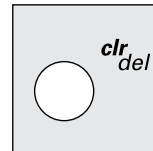

clr/del (clear/delete)

- press button = reverts to basic settings
- other selected functions are cleared

Exceptions:

- needle stop down
- 1/2 motor speed
- when buttonhole is selected, the first step blinks on the display

Stitch overview

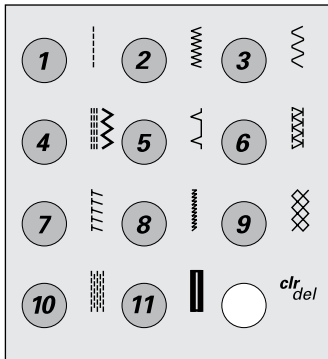

1 Straight stitch

All non-stretch fabrics. All Stitch work

2 Zig-zag stitch

Most fabric types; all simple zig-zag such as oversewing fine fabrics. Sewing on elastic and lace

3 Running stitch

Most types of fabric. Mending, patching, reinforcing seams

4 Triple straight and triple zig-zag stitch

Reinforced seams in tough, heavy fabrics

5 Blind stitch

Most types of fabric; blind hems, shell edging on soft jerseys and fine fabrics, decorative seams

6 Double overlock stitch

All types of knit; Overlock = sew and neaten in one operation

7 Stretch overlock stitch

Mediumweight knits, toweling and firm wovens. Overlock seams, flat joining seams

8 Super stretch stitch

Open seam for all super-stretch fabrics

9 Honeycomb stitch

Most types of interlock and smooth fabrics; visible seams and hems

10 Darning program

Automatic darning for fine and medium weight fabrics

11 Buttonhole

Fine to medium weight woven fabrics; blouses, shirts, trousers, bedlinens, etc.

Straight stitch No. 1



Use reverse pattern sole No. 1 or blindstitch sole No. 5

Outer Edges

- needle position far left for outer edge
- place finished or folded edge of fabric against the left side of the guide on the sole No. 5
- select needle position left at desired distance from the edge

Hem Edges

- needle position far right for inner edge (hem edges)
- place edge of fold (inside upper edge of hem) against the right side of the guide on the sole No. 5
- set to right needle position to stitch along upper edge

Zig-zag stitch No. 2

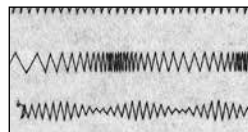

- A** Fabric edges finished with zig-zag stitch
- B** Zig-zag stitch with altered stitch length
- C** Zig-zag stitch with altered stitch width

Use reverse pattern sole No. 1

Zig-zag stitch

- for all fabrics
- for neatening edges
- for decorative work

Satin stitch

- dense (shorter) zig-zag stitch = filled in zig-zag
- adjust stitch width as you sew for new effects

Oversewing edges

- guide edge of fabric under the center of the presser foot
- needle goes into fabric on one strike and over the edge of the fabric on the next stroke
- do not select too wide a width or too long a stitch – the edge should lie flat and not roll
- use darning thread for fine fabrics

Running stitch No. 3

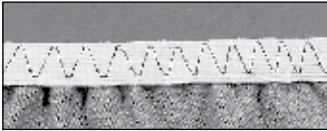

Use reverse pattern sole No. 1

Wide Elastic

- for edges on sportswear and lingerie

Preparation

- cut elastic to length desired
- divide fabric edge and elastic into 4 equal sections and mark
- pin elastic to raw edge, matching up marks

Sewing

- stretch the elastic to fit the raw edge while sewing
- trim excess fabric close to the stitching

Triple straight stitch No. 4



Use reverse pattern sole No. 1

Open Seam

- durable seam for firm and densely woven fabrics such as denim and corduroy
- reinforced seam for garment areas subject to hard wear

Decorative top stitch

- lengthen out stitch and use as a decorative top stitch with denim

Note:

For best results when topstitching with the triple stitch, set the length to 4.

Blind stitch No. 5



Use blind stitch sole No. 5

For «invisible» hems in medium to heavy cotton, wool and blended fabrics.

Preparation

- neaten raw edges
- prepare seam as for sewing by hand
- place work under the presser foot (see drawing)

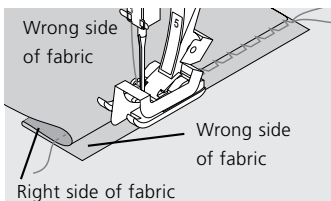

Sewing

- the needle should just pierce the edge of the fold (same as hand sewing)
- adjust the stitch width to suit the fabric
- after sewing about 10 cm (4"), check both sides of fabric and adjust width again if necessary

Double overlock stitch No. 6

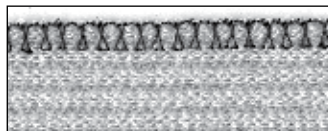

Use reverse pattern sole No. 1 or overlock sole No. 2

Closed seam

Overlock seam in loose knits and cross seams in knits and jerseys.

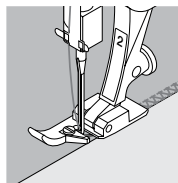

Sewing

- guide the raw edge along the pin on the overlock sole or the reverse pattern sole
- the stitch will form over the pin and over the edge of the fabric

Stretch overlock stitch No. 7

TTTTT

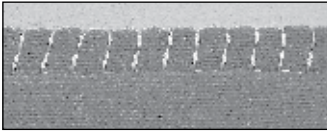

Use reverse pattern sole No. 1

Closed Seam

- overlock seam in coarse or loose knits

Sewing

- sew stretch overlock along the fabric edge
- the stitch should sew over the edge of the fabric on the right sewing of the needle

Super stretch stitch No. 8

NNNNNN

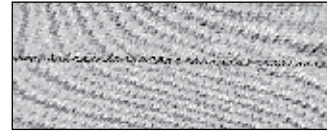

Use reverse pattern sole No. 1

Open Seam

- very elastic seam for knit fabrics
- ideal for sports and leisure wear
- seam lies flat and is not bulky

When using heavyweight fabrics (rolling edges) sew 3/8" (1cm) in from the edge and cut off seam allowance.

Honeycomb stitch No. 9

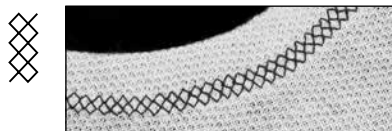

Use reverse pattern sole No. 1

Ribbing with visible seam

- for all cotton, wool, synthetic and mixed fiber jersey

Preparation

press 1 cm (3/8") to wrong side

Sewing

- sew from the right at a foot's width from the edge
- trim surplus fabric (wrong side)
- adjust balance if necessary

Balance/corrections

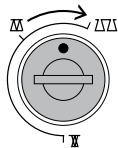
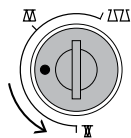

bring stitch together open out stitch

Note:
After sewing
return balance to
the normal set-
ting!

Zippers with Straight stitch No. 1

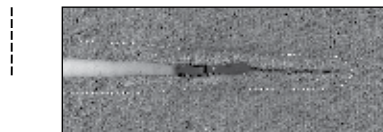

Use zipper sole No. 4

Preparation

- baste in zipper
- fabric edges should meet over the center of the zipper
- needle position far right or far left

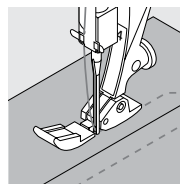

Sewing

- sew in the zipper, each side from bottom to top
- once with needle position far right and once with needle position far left
- the edge of the foot runs along the teeth of the zipper
- the needle inserts close to the teeth

Darning program, stitch No. 10

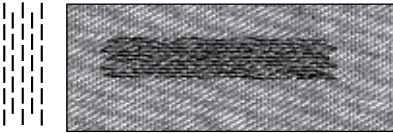

Use reverse pattern sole No. 1

Darning with Reverse pattern sole No. 1 (auto stitch counter)

- insert needle in top left of damaged area
- sew the first length and stop the sewing computer
- press the quick reverse button: length is programmed
- complete the darn; the sewing computer stops automatically
- clear the programme by pressing the «clr/del»-button

Large areas:

- the darning area can be extended by moving the work under the foot

Buttonhole, stitch No. 11

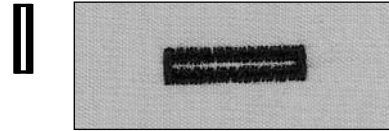

Use buttonhole sole No. 3

Preparation

- select buttonhole
- the LCD display shows the buttonhole number, presser foot sole No. 3 and the buttonhole symbol (the first step blinks on the display)
- insert the lower thread in the finger of the bobbin case = thread tension is a little higher
- mark the buttonhole length in the appropriate position

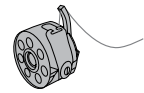

Test sewing

- test on the fabric and stabilizer you intend to use
- sew buttonholes in the same grain direction (with or against)
- cut the buttonhole open
- push the button through and adjust length if necessary

Manual buttonholes are particularly suitable for single buttonholes, for repairing existing buttonholes or to decorative effect. Manual buttonholes cannot be saved.

Sewing a manual standard buttonhole

Both beads are sewn in the same direction.
The individual steps blink on the LCD display.

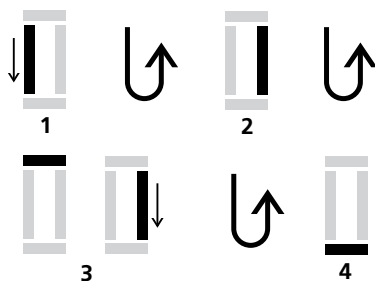

- 1 sew the first bead forward, stop the sewing computer
 - press the reverse button
- 2 sew reverse straight stitch, stop the sewing computer at the first stitch (buttonhole begin)
 - press the reverse button
- 3 sew the bartack and the second bead, stop the sewing computer
 - press the reverse button
- 4 sew the bartack and the securing stitches

Individual steps can be eliminated or repeated.

Corrections

To adjust the bead width

- alter the stitch width
- altered stitch widths can be deleted by pressing the «clr/del»-button

Altering the stitch length

- any alterations to the stitch length affect both beads (denser or less dense)
- altered stitch length can be deleted by pressing the «clr/del»-button

Balance for manual buttonholes

- any balance alterations to the manual buttonholes affects both beads identically because they are sewn in the same direction

Note:

When all buttonholes have been sewn, return balance to the normal setting!

Important facts about sewing needles

Your **BERNINA** uses needle system 130/705H.

Needle and thread

The most commonly sold needles are nos. 70–120. The finer the needle, the lower the number. The table shows which needle is suitable for which threads.

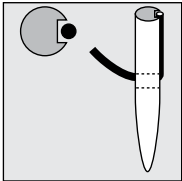

Needle appropriate for thread

When sewing, the thread runs in the long groove on the needle.

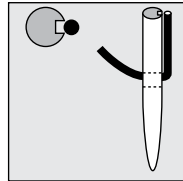

Needle inappropriate for thread

If the needle is too fine, the groove will be too narrow for the thread and faulty stitching or thread breakage can occur.

Needle and fabric

Condition of needle

The needle must be in perfect condition. Problems can occur with damaged needles.

Needle	70	80	90	100	110–120
Darning thread	•	•			
Mercerised cotton thread		•	•		
Synthetic thread		•	•		
Thick threads, synthetic mercerised thread			•	•	
Buttonhole thread for decorative seams (cordonnet)				•	•

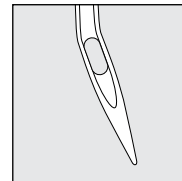

bent needle

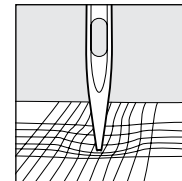



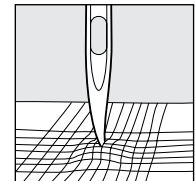

blunt needle

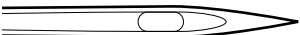
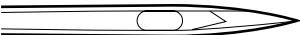
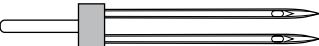

hooked needle

Special materials are easier to sew if the appropriate needle is used.
Special needles are available at your **BERNINA** dealer.

Type of needle	Model	Suitable for	Needle size
Universal 130/705 H	 Normal point, slightly rounded	For nearly all natural and synthetic fabrics (woven and knitted)	60–100
Jersey/Stretch 130/705 H-S 130/705 H-SES 130/705 H-SUK	 Ball point	Jersey, stretch fabrics	70–90
Jeans 130/705 H-J	 Very fine point	Heavyweight fabrics such as denim, canvas, overalls	80–110
Leather 130/705 H-LL 130/705 H-LR	 Cutting point	Natural and synthetic leather and plastic	90–100
Double needle 130/705 H-ZWI	 Needle distance: 1.0 / 1.6 / 2.0 / 2.5 / 3.0 / 4.0	Visible hems in stretch fabrics, pintucks, decorative sewing	70–100
Triple needle 130/705 H-DRI	 Needle distance: 3.0	Decorative sewing	80
Wing needle 130/705 HO	 Wing needle (wing)	Hemstitch	100–120

Cleaning



If the sewing computer is stored in a cold room, it should be brought to a warm room about one hour before use.

Clean the sewing computer after every use

- turn power switch to «0» (off) and pull out plug from electric outlet
- remove presser foot and needle
- open the free-arm cover
- press the stitch plate down at the back right corner, lift and remove
- clean the area with the lint brush
- replace the stitch plate

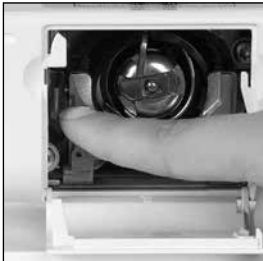

Cleaning the hook

- turn power switch to «0» (off) and pull out plug from electric outlet
- remove the bobbin case
- push the release lever to the left
- push the locking lever to the left and fold down the hook race cover
- remove the hook
- clean the hook race with a cloth or brush, never use a sharp instrument
- replace the hook, turning the handwheel if necessary so that the hook driver is on the left
- close the hook race cover and secure with the locking lever, the locking pin must engage
- check by turning the handwheel
- insert the bobbin case

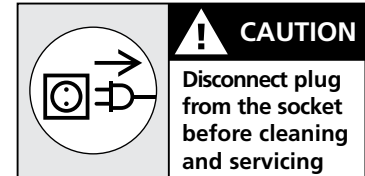

Lubricating

- squeeze 1–2 drops of oil into the hook race
- run the machine for a short time without thread to prevent oil soiling your work

Cleaning the LCD display and the sewing computer

- wipe with a damp cloth

Important!

Never use alcohol, petrol, white spirit or any type of solvent to clean the sewing computer!



Please refer to the safety instruction!

Trouble shooting

In most cases you will be able to identify and remedy faults by checking the following.

Check whether:

- the upper and lower threads are threaded correctly
- the needle is inserted correctly
- the needle size is correct – check the needle/thread table p. 31
- the sewing computer is clean – brush out any thread fluff
- the hook race is clean
- any threads are trapped between the tension discs or under the bobbin case spring
- the bobbin runs smoothly in the case or if remnants or lint need removing

Lower thread breaks

- The lower thread tension is too tight.
- The bobbin is jamming in the bobbin case. Remove and replace the bobbin.
- The hole in the stitch plate has been damaged by the needle. This must be repolished by an expert.
- The needle is blunt or bent.

Upper thread breaks

- The upper thread tension is too tight.
- The needles are of a poor quality. Ideally needles should be purchased from your **BERNINA** dealer.
- The needle is bent or blunt.
- Poor quality, knotted or dried out thread has been used.
- Use the correct spool disc.
- Stitch plate or hook tip damaged. Take your sewing computer to your **BERNINA** dealer.

Skipped stitches

- Wrong needles used. Use only 130/705H system.
- The needle is blunt, bent or incorrectly inserted.
- Push right to the top when inserting.
- Needle inserted all the way to the top.
- The needle point does not suit the fabric being sewn. If necessary use a ball point for knitted fabrics and cutting point for hard leather.

Needle breaks

- Needle clamp screw loose.
- Fabric taken out in front instead of behind presser foot.
- When sewing over thick area, the fabric was pushed with the needle still in the fabric.
- Poor quality thread, unevenly wound or knotted.
- See pages 31 and 32 for information about needles.

Faulty stitching

- Remnants of thread between the tension discs.
- Remnants of thread under the bobbin case spring.
- Lower thread still threaded in the bobbin case finger.
- Sewing computer threaded with foot down.
- Incorrect threading. Check upper and lower threads.
- Use the correct spool disc.

Sewing computer fails to run or runs slowly

- Plug not properly inserted.
- Power switch in off position.
- Sewing computer has been standing in a cold room.
- Bobbin winder still switched on.

Index

A		F		O		T	
Accessories	8–11	Fabric cover	8	Optional accessories	10, 11	Thread cutter	12, 13, 17
Accessory case	8	Fabric feed	18			Thread tension	19
Altered stitch memory	21	Feed-dog	18	P		Threading	16
B		Foot control	8, 10	Power cable	8	Threads	31
Balance	20, 28, 30	H		R		Triple straight stitch	23, 25
Blind stitch	23, 26	Honeycomb stitch	23, 28	Reverse sewing	22	Trouble shooting	34
Bobbin	12–14	I		Running stitch	23, 25	U	
Bobbin case	13	Inserting the bobbin	14	S		Upper thread	16
Bobbin thread cutter	12, 13	L		Seam guide	10	W	
Buttonhole	29, 30	LCD display	21	Sewing light	11	Winding the bobbin	12
C		Lens Set	10	Sewing table	10	Z	
Changing the presser foot sole	15	M		Snap-on soles	9	Zig-zag stitch	23, 24
Changing the needle	14	Maintenance	33	Spool pin	15	Zippers	28
Cleaning	33	1/2 Motor speed	22	Standard accessories	8, 9		
Clear / Delete	22	N		Start-stop-unit	11		
D		Needle position	21	Stitch length/width	21		
Darning program	23, 29	Needle stop	22	Stitch overview	23		
Delete / Clear	22	Needle Threader	17	Stitch plate	18		
Details of the sewing computer	6–7	Needle up/down	22	Stitch selection	21		
Display	21	Needles	31, 32	Straight stitch	23, 24, 28		
Double overlock stitch	23, 26			Stretch overlock stitch	23, 27		
				Super stretch stitch	23, 27		
				Supplementary spool pin	15		

Imprint

Typesetting, Layout, DTP: Silvia Bartholdi
Graphics: Müller-Melzer ID, Kreuzlingen

© copyright 2010

BERNINA International AG, Steckborn

All rights reserved

For technical and product improvement reasons, the sewing computer's features, parts and accessory are subject to unannounced changes and alterations at any time. The accessory included can differ from country to country.

BERNINA

