

Dear BERNINA 820 customer,

Congratulations! With the purchase of the BERNINA 820, you have acquired the ultimate sewing and quilting computer available in today's market. By purchasing the 820, you have established that you are a creative person who is looking for the opportunity to explore and expand the unlimited world of creativity.

The use of modern, future-oriented technologies in the computerized sewing field coupled with the tradition of BERNINA quality and reliability offer you the best of the future and the best of the past. With the BERNINA 820 you will be able to sew faster, smarter, longer, and more creatively – and with more enjoyment. We have put all the dreams that our customers have shared with us into this product.

BERNINA wants you to fully enjoy the enormous possibilities that the BERNINA 820 sewing system offers you. To do so, you must learn all the wonderful features of the product. Therefore, don't hesitate to frequent your local BERNINA dealer and tap into the knowledge of the BERNINA educators.

I wish you much happiness and great satisfaction while enjoying your creative pastime.

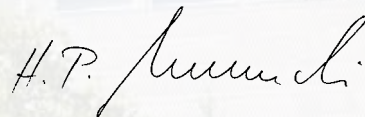

H.P. Ueltschi
President
BERNINA International AG
CH-8266 Steckborn
www.bernina.com



IMPORTANT SAFETY INSTRUCTIONS

When using an electrical appliance, basic safety precautions should always be followed, including the following:

Read all instructions before using this sewing computer.

When the sewing computer is not in use, it should be disconnected from the electricity supply by removing the plug from the outlet.

DANGER!

To reduce the risk of electrical shock:

- 1 An appliance should never be left unattended when plugged in.
- 2 Always unplug this sewing computer from the electrical outlet immediately after using and before cleaning.
- 3 LED Radiation – Do not view directly with optical instruments. Class 1M LED product.

WARNING!

To reduce the risk of burns, fire, electric shock or injury to persons:

- 1 Use this sewing computer only for its intended use as outlined in this manual. Use only attachments, accessories and parts recommended by the manufacturer.
- 2 Do not use the sewing computer as a toy. Caution is advised when the sewing computer is used by children, or near children. The sewing computer is not intended for use by persons (including children) with reduced physical, sensory or mental capabilities or lack of experience and knowledge, unless they have been given supervision or instruction concerning use of the sewing computer by a person responsible for their safety. To ensure children do not play with the sewing computer they must be supervised.
- 3 Never operate this sewing computer if:
 - ▶ the cord or plug are damaged
 - ▶ it is not working properly
 - ▶ it has been dropped or damaged
 - ▶ it has fallen into water

Return the sewing computer to your local authorized BERNINA dealer for examination or repair.

- 4 Never operate the sewing computer with any air openings blocked. Keep ventilation openings of the sewing computer and foot controller free from the accumulation of lint, dust and loose cloth.
- 5 Keep fingers away from all moving parts. Special care is required around the sewing needle.
- 6 Never drop or insert any objects into any openings on the sewing computer.
- 7 Do not use the sewing computer outdoors.
- 8 Do not operate the sewing computer where aerosol products (sprays) or oxygen are being used or where oxygen is being administered.

- 9 Do not pull or push fabric while stitching - this may cause the needle to break.
- 10 Do not use bent needles.
- 11 Always use a proper BERNINA stitch plate. The wrong plate can cause needle breakage.
- 12 To disconnect, turn all controls to the OFF («0») position, then remove the plug from the outlet. To unplug, pull the plug not the cord.
- 13 Turn all controls OFF (to the «0» position) when making any adjustments in the needle area - such as changing or threading the needle, presser foot etc.
- 14 Always unplug the sewing computer from the electrical outlet when removing covers, lubricating, or when making other user servicing adjustments mentioned in this instruction manual.
- 15 This sewing computer is provided with double insulation (except USA and Canada). Use only identical replacement parts. See instructions for servicing of double-insulated products.

SERVICING DOUBLE INSULATED PRODUCTS

In a double-insulated product two systems of insulation are provided instead of grounding. No grounding means is provided on a double-insulated product, nor should a means for grounding be added to the product. Servicing a double-insulated product requires extreme care and knowledge of the system and should be done only by qualified service personnel. Replacement parts for a double-insulated product must be identical to those parts in the product. A double-insulated product is marked with the words «DOUBLE INSULATION» or «DOUBLE INSULATED».

The symbol  may also be marked on the product.

DISCLAIMER

No liability will be assumed for any possible damage which arises from misuse of this sewing computer.

This sewing computer is intended for household use only.

SAVE THESE INSTRUCTIONS!

Sewing

Accessory & Preparation

Functions & Settings

Main Stitch Categories

BERNINA World

Maintenance/Troubleshooting

Stitch Patterns

Index



Very important!
Risk of damage!



Helpful tips!

Text

Gayle Hillert, Herbert Stolz, Joanna Wild

Sewing Projects

Colette Cogley, Jeanne Delpit, Susan Fears, Claudia Giesser,
Gayle Hillert, Nina McVeigh, Pia Welsch, Joanna Wild

Screen Design & Drawings

sculpt.ch, CH-Steckborn

Photographs

Sterling Rice Group, USA
Patrice Heilmann, CH-Winterthur

Manual Design & Concept

Erika Vollenweider-Czibulya

Typesetting, Layout, DTP

Susanne Ribl, Erika Vollenweider-Czibulya

Copyright

2008 BERNINA International AG, CH-Steckborn



All rights reserved

For technical and product improvement reasons, the sewing computer's features, parts and accessory are subject to unannounced changes and alterations at any time. The accessory included can differ from country to country.

Accessory & Preparation

Accessory	6	Stitch plates	23
Your Delivery	6	Feed-Dog and Fabric Feed	23
Sewing computer cover	6	Sewing with the Height Compensation Tool	24
Accessory	6	Sewing Corners	24
In plastic bag	6		
Presser Feet	7	Thread Tension	25
BERNINA Specialty presser feet	7	Upper Thread Tension	25
		Lower Thread Tension	25
		Altering the Tension	25
Accessory Box	8	Needle	26
Free Standing	8	Important facts about Thread and Needles	26
Lay-out	9	Thread	26
		Needle, Thread and Fabric	26
Sewing Computer	10	Needle/Thread	26
Details	10	Guidelines	27
Preparation	12	Overview	28
Battery	12		
Power Switch/Power Cable	12		
Free-Hand-System (FHS) Presser Foot Lifter	12		
Foot Control	13		
LED Sewing Light	13		
Pivotable Triple Spool Holder	14		
Bobbin	14		
Winding the Bobbin	15		
Interrupting the winding process	15		
Removing/Inserting the Bobbin	16		
Slide-on Table	17		
Thread Cutter	17		
Threading the Upper Thread	18		
Double/Triple Needle	19		
Thread-Guide-and-Lubricating Unit	20		
As a thread-guide eyelet	20		
As a thread lubricator	20		
Assembly	20		
Radial Thread Guide	21		
Various Options of Application	21		
Changing the Needle	22		
Changing the Presser Foot	22		

Your Delivery



Sewing computer cover

- ▶ protects from dust and dirt

Accessory

- ▶ foot control
- ▶ power cable
- ▶ warranty card
- ▶ FHS presser foot lifter (Free Hand System)
- ▶ slide-on table
- ▶ seam guide for slide-on table
- ▶ Instructional DVD
- ▶ sewing computer cover
- ▶ accessory box
- ▶ thread lubricator



In plastic bag

- 1 4 bobbins
- 2 adjustable guides
- 3 wire threader for threading cording for bobbin play
- 4 tweezers
- 5 2 nets
- 6 cording attachment
- 7 magnifying glass adapter
- 8 small screwdriver, gray
- 9 touch pen
- 10 seam ripper
- 11 lint brush
- 12 multifunction tool
- 13 manual threader
- 14 spool disc small
- 15 holder for king-size spools, cone holder
- 16 height compensating tool
- 17 needle pack 130/705H
- 18 lubricator
- 19 monitoring mirror
- 20 hook cleaning tool

Presser Feet



1C Reverse pattern foot



1D Reverse pattern foot



3A Automatic buttonhole foot with slide



4D Zipper foot



5 Blindstitch foot



20C Open embroidery foot



37D Patchwork foot



42 BSR foot

BERNINA Specialty presser feet



8 Jeans foot



50 Walking foot



It is recommended that BERNINA specialty presser feet be used for specific sewing tasks such as quilting, heirloom sewing, home decorating, tailoring etc. All the presser feet are shown in the enclosed accessory catalog. They are available at your BERNINA dealer.

Accessory Box

Free Standing



- ▶ on the back of the box, pull both extensions out until they click into place

Lay-out

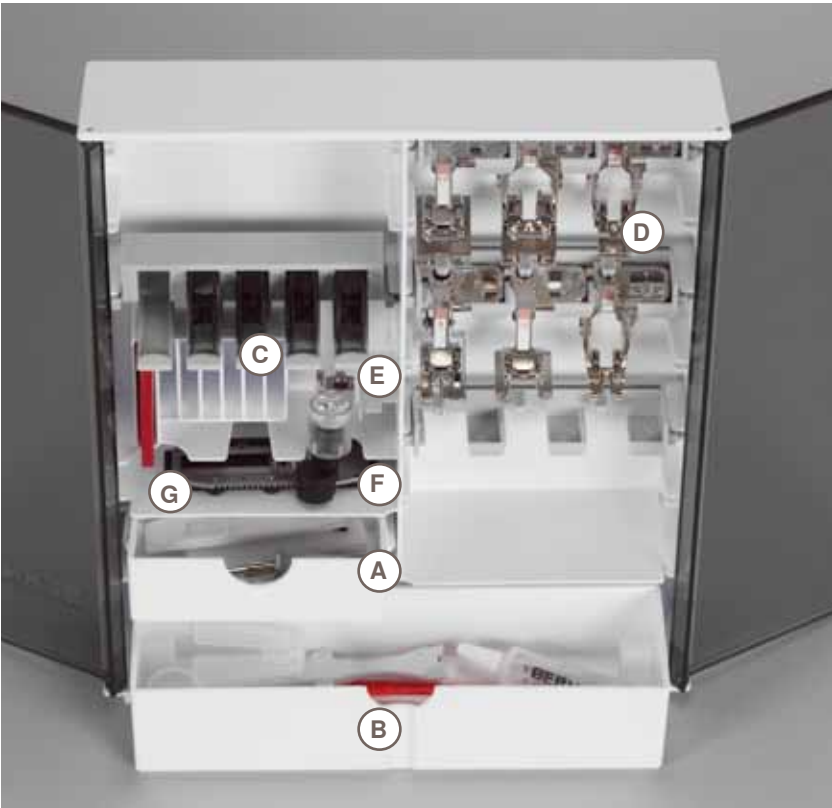

The box is equipped as standard with one small **A** and one large **B** drawer as well as a compartment for bobbin holders **C** and presser feet **D**.

- ▶ to remove a bobbin, press the compartment holder **E** lightly
- ▶ buttonhole foot with slide no. 3A can be stored in the left compartment **F**
- ▶ store the needle range supplied in the special compartment **G**

Details

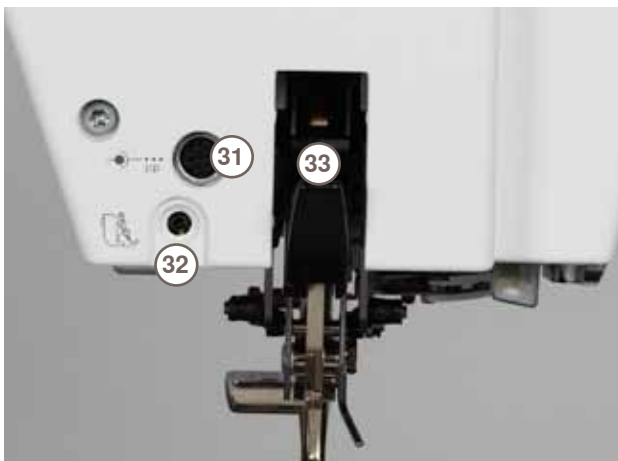

- 1 Bobbin cover
- 2 Stitch plate
- 3 Attachment base for special accessories
- 4 Presser foot
- 5 Needle clamp
- 6 Thread guide
- 7 Screen
- 8 Carrying handle
- 9 System Settings
 - ▶ Setup button
 - ▶ Tutorial button
 - ▶ Creative Consultant button
 - ▶ Help button
 - ▶ Eco button
 - ▶ «clr» clear button
- 10 Stitch width knob
- 11 Stitch length knob
- 12 Needle position buttons
- 13 Bobbin winder
- 14 Thread cutter for bobbin winder
- 15 Threading slit
- 16 Triple spool pin
- 17 Telescope
- 18 Bobbin pre-tension
- 19 Slide-on table socket
- 20 Darning hoop connection
- 21 FHS (Free Hand System) connection
- 22 Slide speed control
- 23 Automatic needle threader
- 24 Needle stop up/down button
- 25 Presser foot up/down button
- 26 Securing button
- 27 Pattern end button
- 28 Automatic thread cutter
- 29 Start/Stop Button
- 30 Quick reverse button
- 31 Special-accessories port
- 32 BSR connection
- 33 BERNINA Dual Feed
- 34 Handwheel
- 35 USB connection
- 36 PC connection
- 37 Foot control socket
- 38 Power switch on/off («I», «0»)
- 39 Power plug socket
- 40 Connection for Magnifying glass (optional accessory)
- 41 Thread cutter on head frame

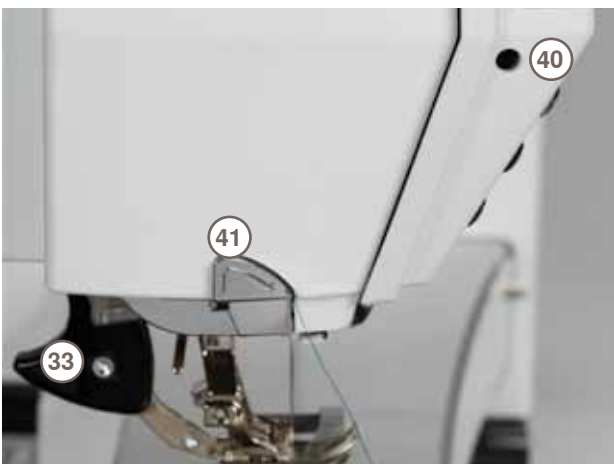

Battery

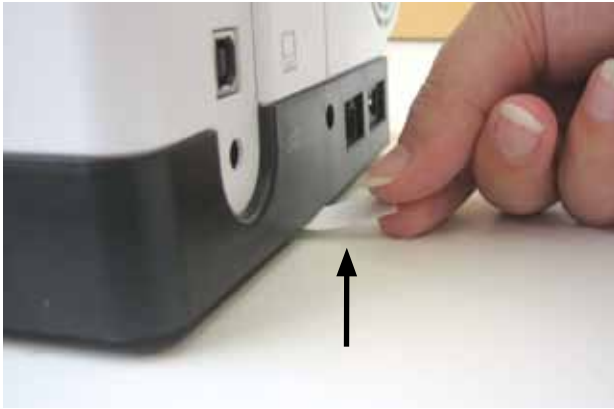

Please remove the protective sticker of the battery before taking the sewing computer in use.

Power Switch/Power Cable



A Power Switch

The sewing computer is switched on («I») and off («0») with the power switch.

I the sewing computer is switched on
0 the sewing computer is switched off

B Power connection
C Foot control connection
D PC connection
E USB stick connection



If the sewing computer is kept in a cold room, place it in a warm room for 1 hour before use.



(USA/Canada only):

The sewing computer has a polarized plug (one blade wider than the other). To reduce the risk of electrical shock, this plug is intended to fit in a polarized outlet only one way. If the plug does not fit fully in the outlet, reverse the plug. If it still does not fit, contact a qualified electrician to install the proper outlet. Do not modify the plug in any way!

Free-Hand-System (FHS) Presser Foot Lifter



The FHS is used to raise and lower the Presser Foot.

Attaching the Free Hand System

► insert into the opening; you should be able to operate the FHS with your knee in your normal sitting position

Raising and Lowering the Presser Foot

► with knee push FHS to the right
 ► the presser foot is raised and the feed-dog is lowered simultaneously. Tension is released
 ► the feed-dog is raised as soon as the first stitch is sewn



Your dealer can adjust the FHS if necessary.

Foot Control



Sewing Speed

- ▶ sewing speed is controlled by pressure on the foot control

Raise or Lower the Needle

- ▶ entire foot rests comfortably on Foot Pedal
- ▶ tap the Foot Control with your heel to raise or lower the needle



Cable tidy

- ▶ wind the cable around the reel
- ▶ insert the cable end (plug) into A

When sewing

- ▶ unwind the cable to the desired length and slip into B or C



(USA/Canada only):

Use only foot controller type LV1 or WFC1 with sewing computer model 820.

LED Sewing Light



The LED sewing light illuminates the sewing area with no shadows and has a very long service life.



A defective sewing light must only be replaced by a technician.

Take the sewing computer to your BERNINA dealer.

Pivotable Triple Spool Holder

Preparation

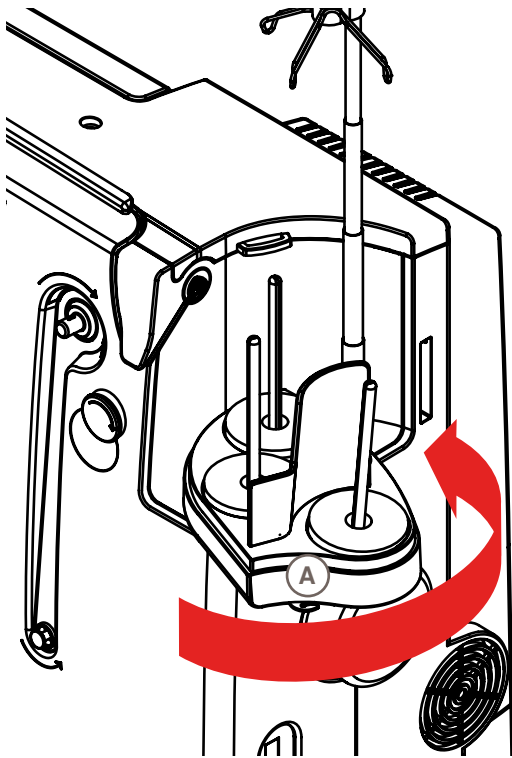

- ▶ remove spool-pin cover vertically upwards
- ▶ pull out the telescopic rod and ensure that all the parts snap into place
- ▶ swing spool pin to the right until it is engaged. This ensures a good overall view and access to the spool pins
- ▶ eyelet **A** is used when winding a bobbin

Bobbin

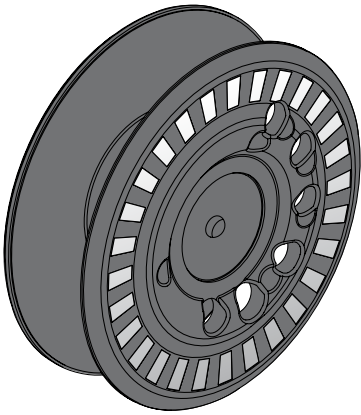

The 820 bobbin, exclusive to BERNINA, supplies till 40% more lower thread. If the bobbin is not inserted correctly, an error message is displayed.



You can preselect a bobbin fill of 25%, 50% or 100%.



Treat the bobbins with care. Keep the white sensor surfaces free of scratches or stains to ensure correct functioning of the lower thread indicator. Store the bobbins in the respective compartment of the accessories box.

Winding the Bobbin

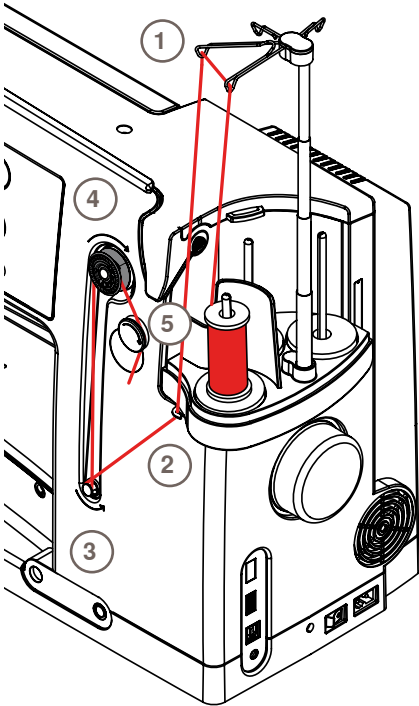

Preparation

- ▶ turn power switch on (to «I»)
- ▶ place empty bobbin on Pin, white mark in front
- ▶ the bobbin winding screen appears
- ▶ the amount of bobbin fill is recognized by the system and displayed by bar below the selectable bobbin fill
- ▶ place thread spool on the front spool pin and thread the respective guides 1 on the telescope

Winding the Bobbin

- ▶ hold thread with both hands, guide the thread in the thread guide on the swivel plate 2 in the direction of the arrows and around the bobbin pre-tension 3
- ▶ wind the thread one to two times around the empty bobbin 4 following the direction of the arrows and pull any excess thread in the direction of the arrows, cut off on the thread cutter 5
- ▶ select the bobbin filling, standard = 100%
- ▶ «Start» field = touch bobbin symbol
- ▶ adjust the winding speed with the «+» or «-» Icon or with the stitch width knob
- ▶ winding process stops as soon as the selected fill percentage is reached
- ▶ remove the bobbin and pull the thread over the thread cutter
- ▶ the screen is closed

Manual Winding Mode

- ▶ touch «man»
- ▶ the winder will run as long as the «bobbin» icon is pressed



Interrupting the winding process

- ▶ the winding process can be interrupted by touching «Start»-(bobbin) icon, and the screen closed by touching **X**
- ▶ Continuing the winding process
 - ▶ touch «bobbin» icon (it appears in the place of the clock) = the winding screen opens
 - ▶ touch «Start»-to start winding process

Removing/Inserting the Bobbin

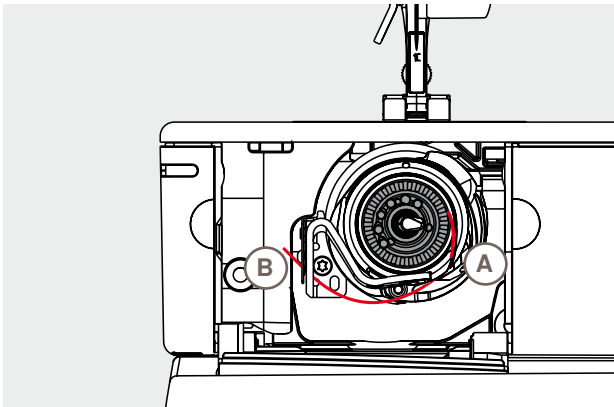
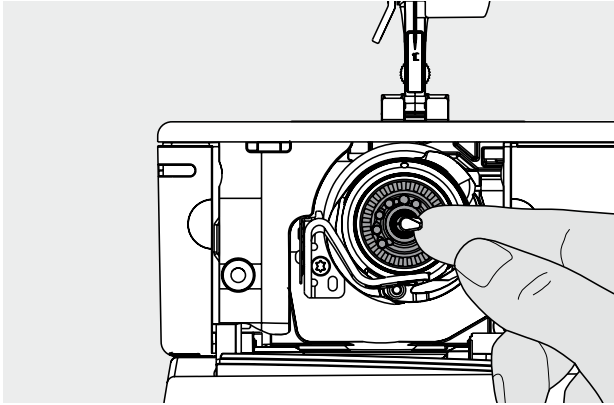

Removing the Bobbin

- ▶ open bobbin cover, the hook system swings to the front
- ▶ push the latch in the center of the bobbin to the left, the bobbin pops out and can be removed

Inserting the Bobbin

- ▶ with bobbin markings facing the front, place the bobbin into the hook and push until it clicks into place

Threading Lower Thread

- ▶ pull the thread to the right into slit **A**, then left under the spring
- ▶ pull thread over thread cutter **B** and cut
- ▶ close the bobbin cover slowly, the hook swings back to the rear



It is not necessary to bring the bobbin thread up through the hole in the stitch plate as the loose end is just the right length to start sewing.



Only remove the bobbin if the hook is at the end position (threading position).



Check the threading path

After threading the hook, hold the mirror under the swung-out hook unit as shown in the pictures below.

- ▶ Position of bobbin thread when threaded for sewing

Slide-on Table



The slide-on table increases the sewing surface.

Attaching the Table

- ▶ raise the needle and presser foot
- ▶ from the left, push table to the right over the free-arm and push firmly so that it engages over the fixing cam

Removing the Table

- ▶ raise needle and presser foot
- ▶ press the button down and remove to the left



Remove the slide-on table only when bobbin cover is closed.



Seam Guide

- ▶ press the release button and insert into the groove (underside of table) from left or right
- ▶ can be moved over the entire table length

Scale

- ▶ «0» corresponds to the center needle position

Thread Cutter



on Head Frame

- ▶ pull both threads from back to front over the cutter and down
- ▶ threads release automatically as soon as the first stitch is sewn



at bobbin winder

- ▶ after winding bobbin, pull thread in direction of arrow over thread cutter and down

Threading the Upper Thread

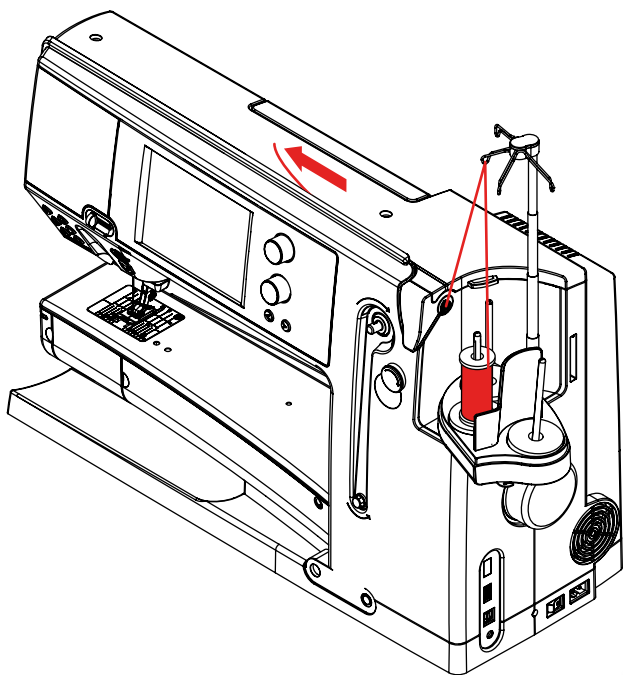

Automatic threading

- ▶ place thread spool on the rear or center spool pin
- ▶ thread the corresponding guide on the telescopic rod, hold with both hands and guide into the threading opening of the sewing computer, taking it up to the thread guide in the needle clamp **A** and **B** and pull from back to front over the thread cutter **C**
- ▶ touch the automatic threader button, a message and an animation appear
- ▶ during threading the Start/Stop Button is illuminated red
- ▶ if the thread has not been threaded correctly, an error message appears
- ▶ close the message with **X** and start again
- ▶ if the thread has been threaded correctly the Start/Stop Button is illuminated green

Manual threading

- ▶ follow the two first steps as described above
- ▶ touch «Manual threading» icon on screen
- ▶ press «Automatic threading» button, then thread the needle by hand

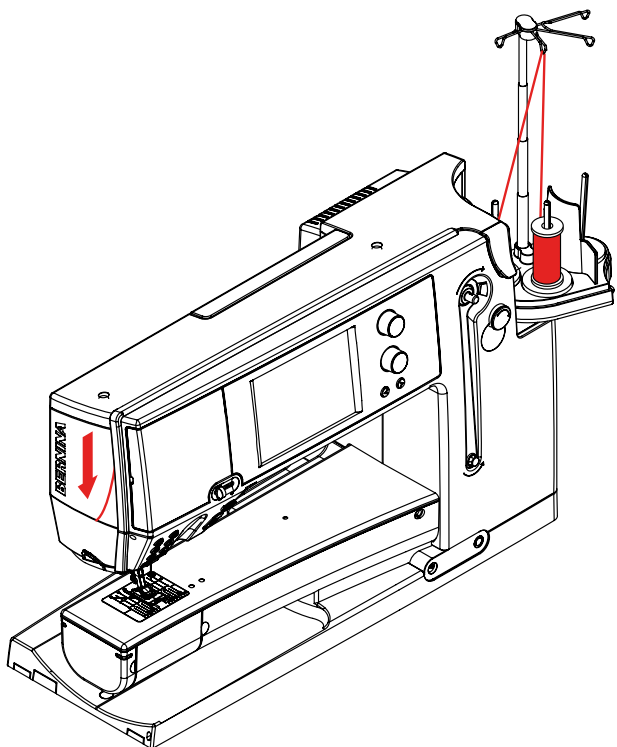

- ▶ when using unruly threads, slip the net over the upper thread spool
- ▶ large net for large spools, small net for small spools
- ▶ this prevents the upper thread from slipping and gives an even thread feed
- ▶ place the thread(s) under the presser foot and to the back before starting to sew



Do not start the threaded sewing computer if there is no fabric on the stitch plate.

The sewing computer must be switched ON for threading.

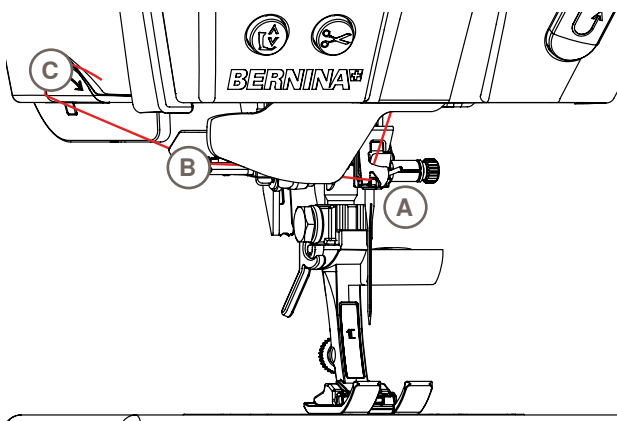

Double/Triple Needle

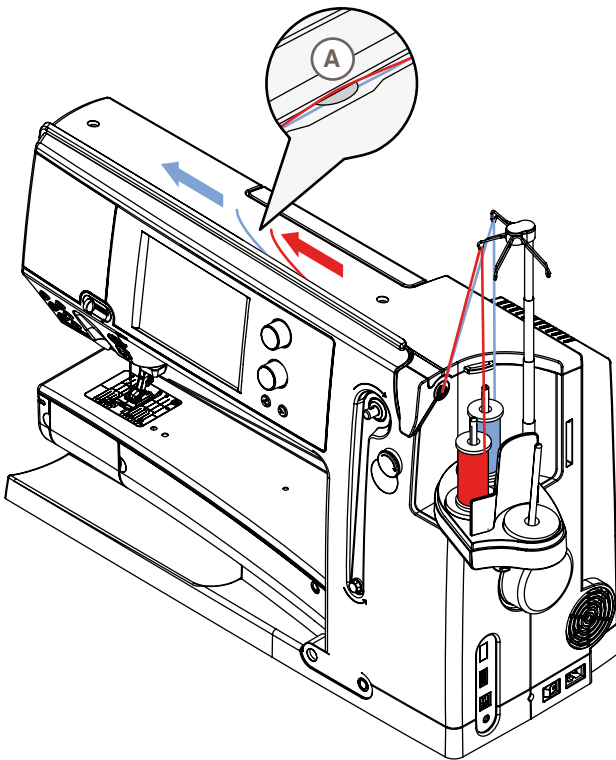

Double Needle

- ▶ touch the «Security Program» icon
- ▶ touch the appropriate needle icon (double needle) in the Security Program screen
- ▶ place a thread spool on the center spool pin and one on the rear spool pin and thread the corresponding guides on the telescopic rod
- ▶ insert the two threads together into the threading slit, guiding the thread of the rear spool pin **behind** the thread-tension disc **A** while guiding the thread of the center spool pin **in front of** the tension disc **A**. Then guide the two threads through the thread guide at the needle clamp
- ▶ touch the icon «Manual Threading» on the threading animation screen. Next touch the illuminated automatic threading button
- ▶ using the manual threader in your accessory kit, manually thread the left needle and then the right needle

Triple Needle

- ▶ in the Security Program select triple needle
- ▶ place a thread spool on each spool pin and thread the respective guides on the telescopic rod
- ▶ thread as usual, guiding the thread from the rear and center spool pin in the threading slit **to the rear of** thread tension disc **A** and the thread from the front spool pin **in front of** the tension disc **A**

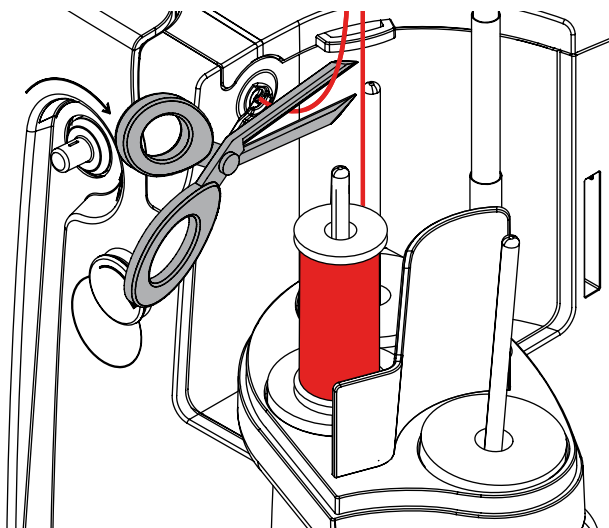
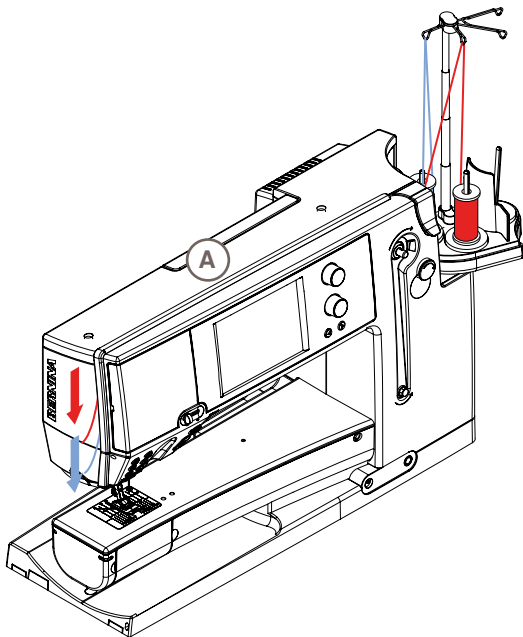

Changing the thread

- ▶ cut the spool thread before the pre-tension and pull out of the sewing computer **to front near the needle**

Thread-Guide-and-Lubricating Unit

As a thread-guide eyelet (Fig. 1)

Use the unit without lubricator for a controlled guiding of the thread into the pretensioner, e.g. when using lively thread types.

As a thread lubricator (Fig. 2)

Using the lubricator is advisable when using e.g. threads with high function values, metallic threads, loosely twisted thread types etc. The silicone fluid improves the threads' gliding properties considerably and therefore helps to produce flawless stitching results.

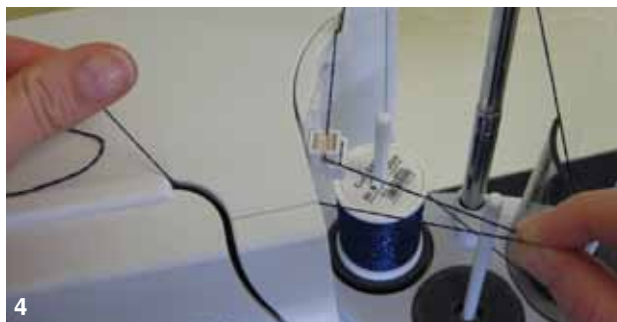
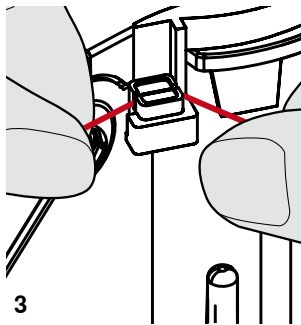
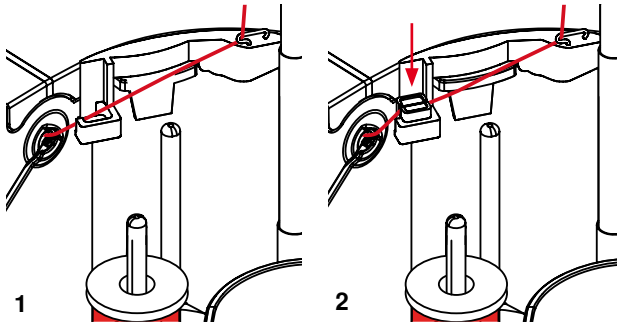

Assembly

- ▶ insert the unit into the spool-holder cover fixture and push down entirely (Fig. 1)
- ▶ insert the lubricator into the holder on the left side of the unit, taking care to place the lubricator in such way that the openings for the thread are in line with the thread flow or thread direction (Fig. 2)
- ▶ moisten the felt, add a few drops of silicone fluid
- ▶ place the thread spool onto the middle or rear spool pin as usual. Then guide the thread through the respective eyelet of the telescopic rod and the eyelet of the thread-guide-and-lubricating unit
- ▶ hold the thread with both hands, pull it in to the slit of the felt, pulling it down as far as it goes so that it'll stay in the felt during machine operation (Fig. 3)
- ▶ continue and complete threading the sewing computer as normal
- ▶ take care that the felt remains moistened. It mustn't dry out. Apply some drops of silicone fluid once in a while to keep it moist
- ▶ during the initial threading of the sewing computer and when the radial thread release is used it is advisable to pull an extra inch of thread from the spool before the threader button is pushed (Fig. 4)



The silicone fluid must ONLY be used for thread lubrication. Never use it to lubricate the hook system!

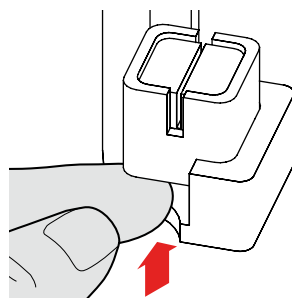

When using the Thread-Guide-and-Lubrication Unit and depending on the type of thread used it might be necessary to reduce the upper-thread tension slightly to achieve perfect stitching results,

- ▶ to remove the Thread-Guide-and-Lubrication Unit, push the entire unit up

Reattach the Thread-Guide-and-Lubrication Unit. Thread the sewing computer as usual, including the eyelet of the unit (Fig. 2).

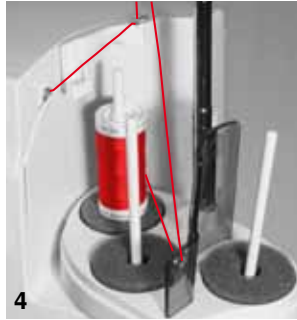
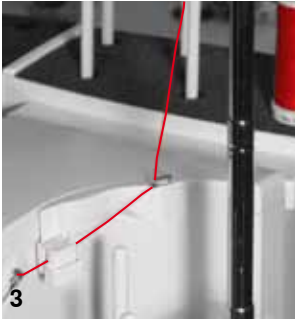
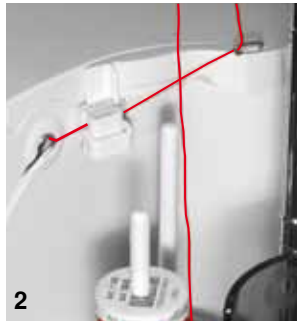
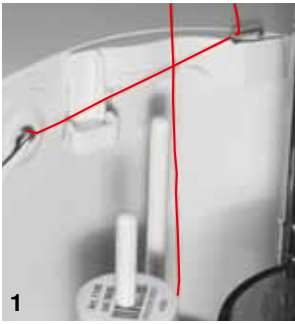

Various Options of Application

► **Vertical thread** unwinding (with or without lubricator) from normal spool pin or optional multiple spool holder (Fig. 1-3)

► **Radial thread** unwinding (with or without lubricator) (Fig. 4)

► during the initial threading of the sewing computer and when the radial thread release is used it is advisable to pull an extra inch of thread from the spool before the threader button is pushed (Fig. 5)

Radial Thread Guide



How to use the thread guide

► it is preferable to replace the standard foam disc with **the foam rotary disc** (with white plastic inner part) on the rear spool pin

The extra thread guide ensures the consistent thread release, when using threads i.e. metallic, lively or even wounded thread spools.

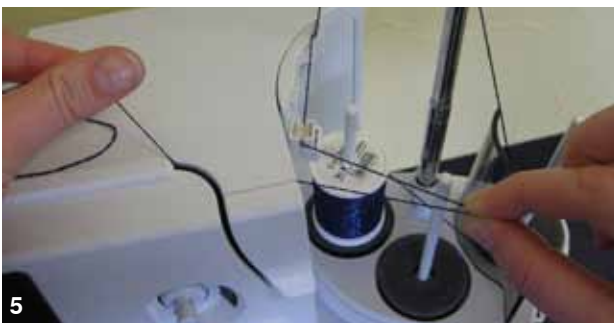

► place thread spool on spool pin and guide thread through thread guide. Then run thread via middle eyelet of telescopic rod. Continue threading the sewing computer as normal

► during the initial threading of the sewing computer and when the radial thread release is used it is advisable to pull an extra inch of thread from the spool before the threader button is pushed

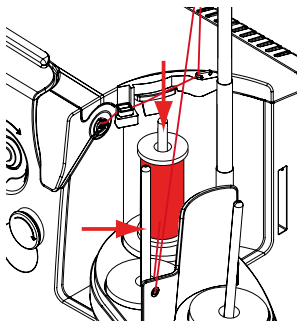

Any of the two spool pins (see arrow markings) can be used. However, it is best to use the rear pin due to its more favourable unwinding angle. Refrain from using the pin of the winder.

In order to achieve perfect stitching results, it might be necessary to reduce the upper-thread tension slightly when using the radial thread unwinding and depending on the thread used.



It is absolutely essential to use the correct foam disc under the thread spool.

Changing the Needle

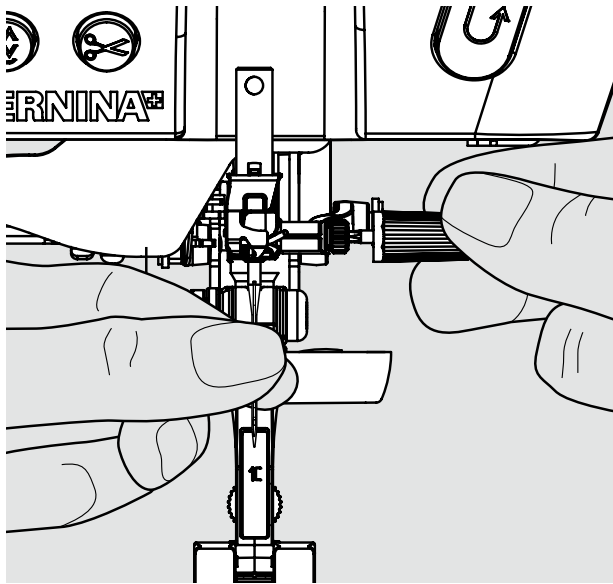

- ▶ raise the needle
- ▶ lower the presser foot and turn the power switch to «0»

Removing the Needle

- ▶ loosen the clamp screw with the gray screwdriver and pull needle down



Turn the handwheel to lower the needle in order to get better access to the fastening screw.

Preparation

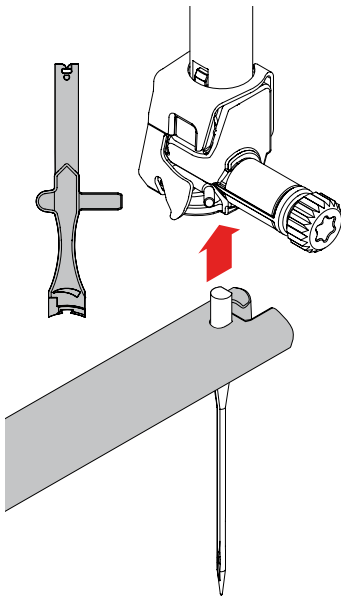

Inserting the Needle

- ▶ flat side of needle to the back
- ▶ insert the needle with the multifunction tool as far as it will go
- ▶ tighten needle clamp screw

Changing the Presser Foot

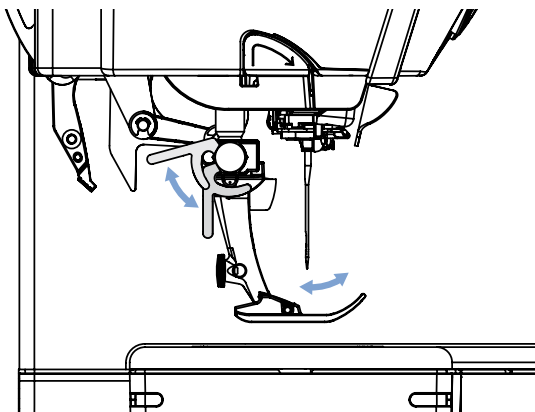

- ▶ raise the needle and presser foot
- ▶ turn power switch to «0» (off)

Releasing the Presser Foot

- ▶ raise the clamping lever
- ▶ remove presser foot

Attaching the Presser Foot

- ▶ guide the presser foot upwards over the cone
- ▶ touch the clamping lever down

Stitch plates

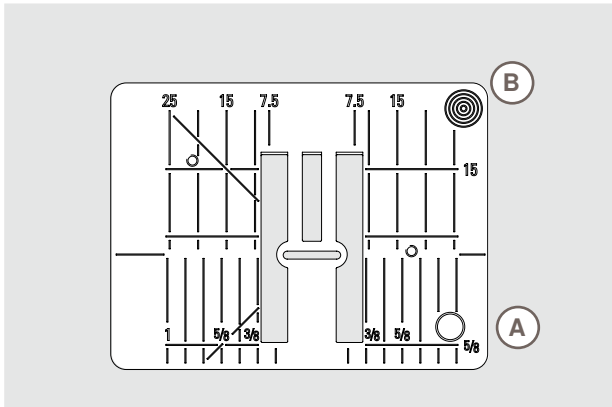

9mm

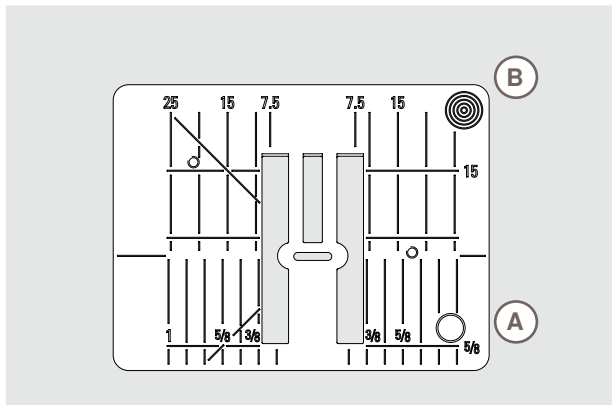

5.5mm (Optional accessory)

Stitch Plate Markings

- ▶ the stitch plates are marked horizontally, vertically and diagonally in mm and inches
- ▶ markings help with sewing e.g. precise seaming and top stitching
- ▶ horizontal markings are helpful for sewing corners and buttonholes etc.
- ▶ diagonal markings are helpful for Quilt piecing
- ▶ the vertical markings refer to the distance from the needle to the marking
- ▶ needle insertion point is position «0» (= center needle position)
- ▶ measurements are marked to the right and to the left of center needle position

Removing the Stitch Plate

- ▶ raise the presser foot and needle
- ▶ turn power switch to «0» (off)
- ▶ press the stitch plate down at the right back corner B until it flips up
- ▶ remove stitch plate

Replacing the Stitch Plate

- ▶ place the stitch plate over the opening A and press down until it clicks into place

Feed-Dog and Fabric Feed

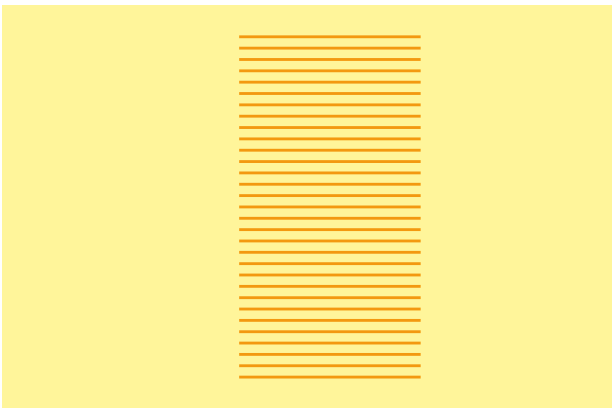

Let the fabric feed fabric evenly.

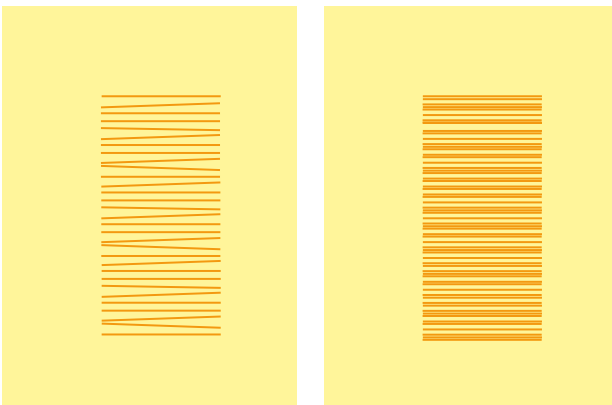

Pulling, pushing or holding back the fabric will result in uneven stitches.

With each stitch the feed-dog moves forward one step. The length of this step is determined by the stitch length selected.

With a very short stitch length the steps are very short. The fabric moves relatively slowly under the presser foot, even at full sewing speed, e.g. buttonholes and satin stitch and decorative stitches are sewn with a very short stitch length.

Sewing with the Height Compensation Tool

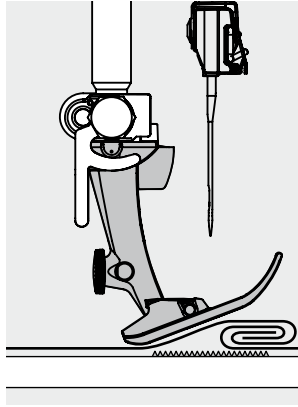
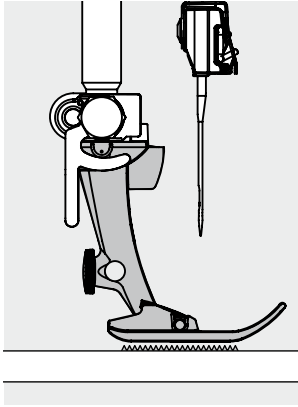

The feed-dog works accurately if the presser foot is level.

If the presser foot is at an angle when sewing over a thick seam, the feed-dog cannot grip. The fabric may jam.

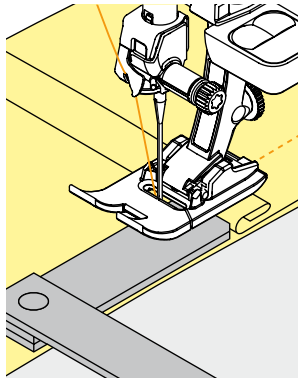
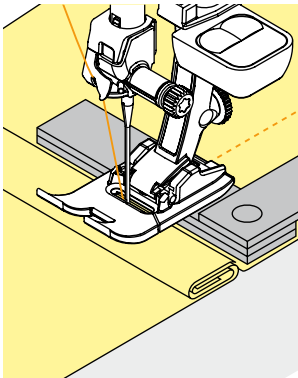

To level the presser foot as required, place one, two or three height-compensating plates behind the needle under the presser foot.

To level the front of the foot, place one or more plates under the right of the presser foot close to the needle. Sew until the presser foot has passed the thick area and remove the plates.

Sewing Corners

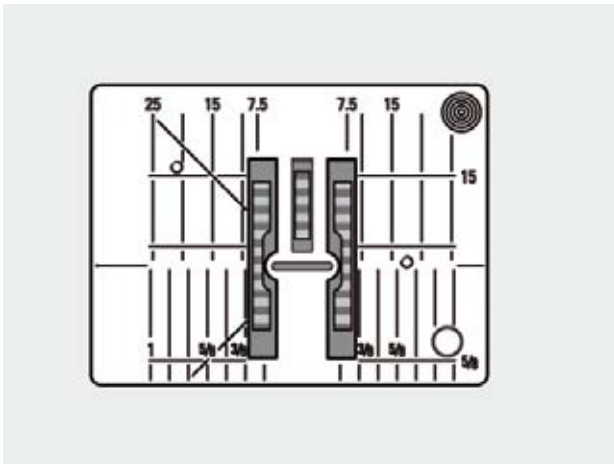

Due to the width of the stitch plate hole the outer feed-dog rows are relatively far apart.

When sewing corners the fabric does not feed well, since only a part of the fabric is on the feed-dog.

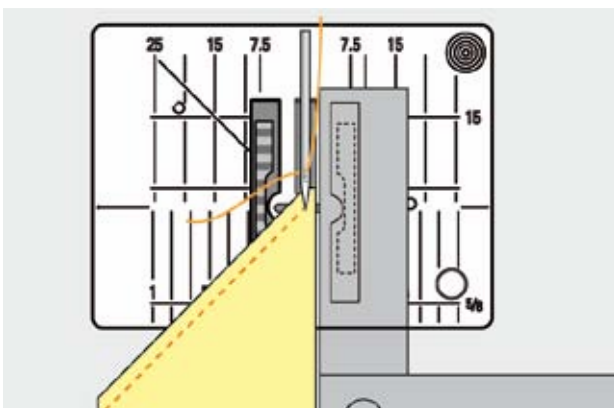

Correct this by placing one or more plates close to the edge of the fabric.

Thread Tension

Upper Thread Tension



Higher upper thread tension = the upper thread is tightened, which pulls the lower thread up to the topside of fabric.

Lower upper thread tension = the upper thread is loosened, which enables it to be pulled to the backside of the fabric.

Basic settings are applied automatically when a stitch pattern or program is selected.

Optimal upper thread tension is set in the factory. For this, Metrosene threads 100/2 weight (Mettler, Switzerland) are used in the bobbin and also in the upper thread.

When using decorative thread, tension adjustments may be necessary to receive optimal stitching results.

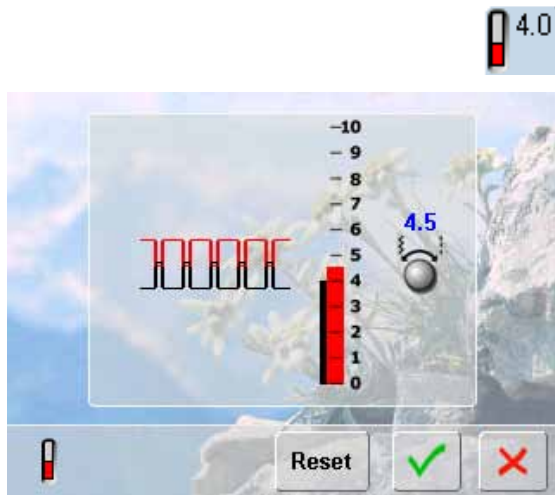

Altering the Tension

- ▶ touch the icon and the optimal stitch formation (stitch formation in the fabric) is displayed
- ▶ the red bar on the scale shows the basic value
- ▶ turn the stitch width or stitch length knob to the left or the right = the thread tension is loosened or tightened
- ▶ the tension alteration is indicated on the right side of the thread tension scale
- ▶ the tension alteration only affects the stitch selected
- ▶ the alteration is shown on the scale (red) and in the function icon
- ▶ the basic setting remains visible (gray) when a change is made
- ▶ the settings are saved by touching ✓
- ▶ touch «Reset» to return to basic settings
- ▶ touch ✗, settings do not change
- ▶ delete: with «clr», «Reset», also when turning off the sewing computer

Lower Thread Tension

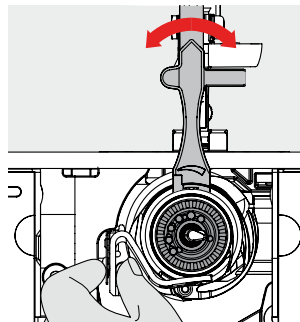
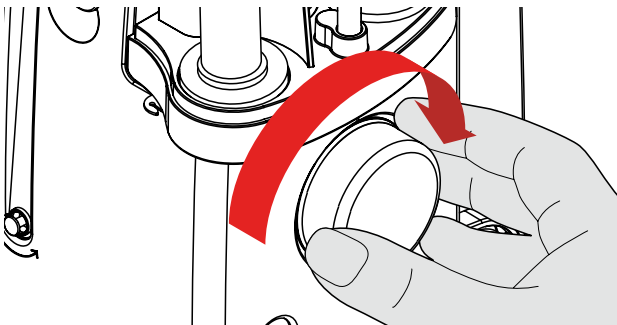

- ▶ hold bobbin case firmly with your left hand; with your right hand, turn the hand wheel clockwise until the setting tool can be slid over the lug at the slider
- ▶ basic value:
 - ▶ lug of the slider matches with the marking of the bobbin carrier, or
 - ▶ lug is shifted 1-2 points to the right, or
 - ▶ lug is shifted 1-2 points to the left
- ▶ turn lug to the left with the setting tool = thread tension becomes looser
- ▶ turn lug to the right with the setting tool = thread tension becomes tighter
- ▶ change per point = 4 g

- ▶ bring hook into the position shown in the illustration by turning the handwheel clockwise in order to be able to thread it properly

Important facts about Thread and Needles

Thread

The thread is chosen according to its intended use. For a perfect sewing result, thread and fabric quality play an important role. Use of quality brands is recommended.

Cotton Thread

- ▶ cotton thread has the advantage of being a natural fiber and is therefore particularly suited for sewing cotton fabrics
- ▶ mercerized cotton thread has a slight sheen and is preshrunk

Polyester Thread

- ▶ polyester thread has a high tensile strength and is particularly colorfast
- ▶ polyester thread is more resilient than cotton thread and is recommended where a strong and elastic seam is required

Needle, Thread and Fabric

Care should be taken when matching the needle and thread.

The correct needle size does not just depend on the thread selected but also on the fabric to be used. The fabric weight and type determines which thread weight, needle size and needle tip to use.



Checking Needle Condition

The condition of the sewing needle should be checked and the needle replaced regularly. A defective needle does not just damage the fabric but also the sewing computer.

As a guide:

Replace the needle before starting a new sewing project.

Needle/Thread

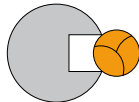
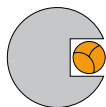

Correct Combination

To sew optimally, the thread should travel smoothly down the long groove on the front of the needle.

Thread Too Thin or Needle Too Thick

The thread has too much clearance in the groove; there may be skipped stitches or damage to the thread.

Thread Too Thick or Needle Too Thin

The thread rubs on the edges of the groove and can get jammed. This can break the thread.

Guidelines



Fabric/Thread	Needle size
Fine fabrics: Fine thread (darning thread, embroidery thread)	70–75
Medium weight fabrics: Normal thread	80–90
Heavy weight fabrics:	100, 110, 120

130/705 H - S / 70

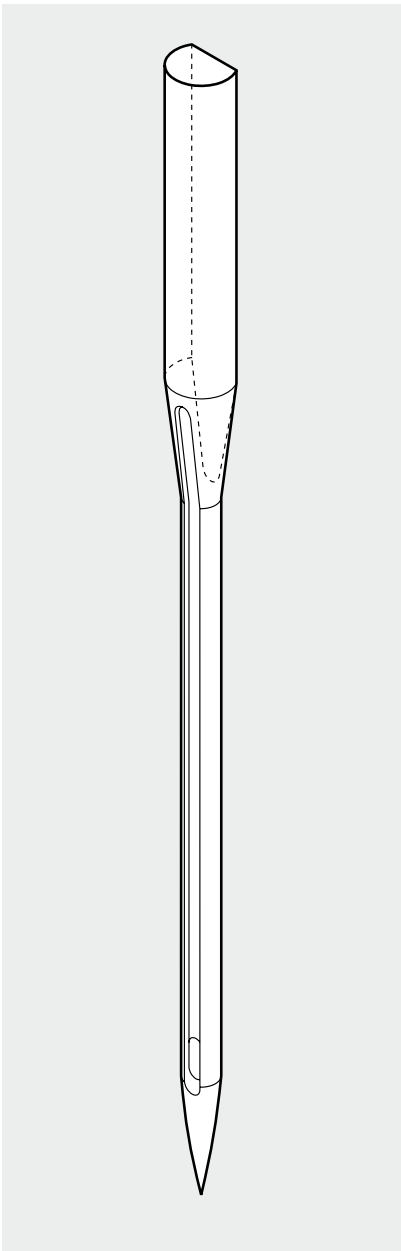

130 Shank length

705 Flat shank

H Needle scarf

S Needle point (here e.g. medium ball point)

70 Needle size (shank diameter)

Overview

Universal

130/705 H/60-100



Normal point, slightly rounded

For nearly all natural and synthetic fabrics (woven and knitted)

Metafil

130/705 H-MET/75-90 or H-SUK/90-100



Large eye

Sewing with metallic threads

Jersey/Stretch

130/705 H-S, H-SES, H-SUK/70-90



Ball point

Jersey, stretch fabrics

Cordonnet (Topstitching)

130/705 H-N/80-100



Small ball point, long eye

Topstitching with thick thread

Leather

130/705 H-LL, H-LR/90-100



With cutting point

All types of leather, synthetic leather, plastic, sheeting

Wing needle (hemstitch needle)

130/705 HO/100-120



Wide needle (wing)

Hemstitching

Jeans

130/705 H-J/80-110



Very fine sharp point

Heavy weight fabrics such as jeans, canvas, overalls

Double wing needle

130/705 H-ZWI-HO/100



For special effects with hemstitch embroidery

Microtex

130/705 H-M/60-90



Especially fine sharp point

Micro fiber fabrics and silk

Double needle

130/705 H-ZWI/70-100



Needle distance: 1.0/1.6/2.0/2.5/3.0/4.0/6.0/8.0

Quilting

130/705 H-Q/75-90



Fine sharp point

Straight and topstitching

Visible hems in stretch fabrics, pin tucks, decorative sewing

Embroidery

130/705 H-SUK/70-90

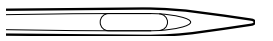

Large eye, slight ball point

Embroidery on all natural and synthetic fabrics

Triple needle

130/705 H-DRI/80



Needle distance: 3.0

For decorative sewing

Functions & Settings

Overview	30	Balance	51
Function Buttons	30	Balance Description	51
Display	32	Practical and Decorative Stitches	51
Functions	34	Corrections	51
Sewing	34	BERNINA Dual Feed	52
Setup Program	36	Balance/Presser Foot Pressure	52
Entry Screen	36	Presser Foot Pressure Settings	52
Display	37	ECO	53
Wallpaper	37	ECO Description	53
Sewing	38		
Securing stitches on/off	38		
Information	40		
Version	41		
Service Data	41		
Screen Calibration	42		
Monitoring	43		
Reset/Delete User Data	44		
Update	45		
Cleaning the sewing computer	46		
Cleaning	46		
Cleaning the needle threading mechanism	46		
Lubricating the hook	46		
Calibrating buttonhole foot no. 3A	47		
Tutorial	48		
Overview of Topics	48		
Creative Consultant	49		
General	49		
Help Program	50		
General	50		
Stitch Pattern	50		
Functions	50		



Start/Stop Button

- ▶ starts and stops the sewing computer when operating it without foot control
- ▶ slightly raise the presser foot when turning or moving the project while sewing - hover position



Quick Reverse Button/Backstepping

- ▶ secures the seam beginning and end: sews in reverse as long as the button is pressed
- ▶ used to program the buttonhole length
- ▶ used to program the darning length
- ▶ used to determine end of stitching in straight stitch Securing stitch no. 5
- ▶ used for securing in Quilters Securing Program no. 1324
- ▶ switching for accurate stitch-by-stitch backstepping (exact retracing of the last 200 needle penetrations)



Pattern End

- ▶ a stop symbol which appears during sewing indicates that the function is activated
- ▶ sewing computer stops at the end of the active single pattern or the active pattern of a combination



Automatic Thread Cutter

- ▶ upper and lower threads are cut automatically
- ▶ 2-6 securing stitches can be programmed in the setup program - these are sewn before the thread is cut



When using metallic or cordonnet thread, use the thread cutter on the head frame only.



Automatic Needle Threader

- ▶ touch button = completes the threading process and threads the needle



Double, triple and wing needles require manual threading after the Automatic Needle Threader button has been pressed. Use the automatic needle threader for needle sizes 70 - 120. Metallic threads, thick threads like cordonnet and difficult to work with threads should be threaded by hand.



The automatic threader mustn't be activated with one of these presser feet attached:
nos. 50, 55, 80, 85 and 86.



Needle Stop Up/Down

In the default setting the needle symbol is displayed above the presser foot indicator.

- ▶ touch the button briefly:
 - ▶ the needle is raised or lowered (as when tapping the foot control with your heel)
- ▶ touch the button longer:
 - ▶ the needle is lowered, the needle symbol is displayed below
 - ▶ the sewing computer stops with the needle down
 - ▶ this becomes your default setting
- ▶ touch the button longer again:
 - ▶ the needle is raised, the needle symbol is displayed above
 - ▶ the sewing computer stops with the needle up



Presser Foot Position

- ▶ touch the button = the presser foot is lowered and raised slightly again so the fabric can be easily positioned. When sewing starts the foot is lowered on to the material
- ▶ touch the button again = the presser foot is raised and the Feed-dog is simultaneously lowered



Automatic Securing Program

- ▶ touch the button before the sewing starts or during sewing = single patterns are secured at the end, with the selected number of stitches programmed
- ▶ touch the button before starting a combination = the first pattern is secured at the end, with the number of stitches programmed
- ▶ touch the button while stitching a combination = the active pattern is secured at the end, with the number of stitches programmed
- ▶ the sewing computer stops automatically after all securing variations
- ▶ the number and type of the securing stitches can be programmed in the setup program

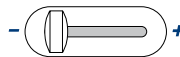

Slide Speed Control

- ▶ the motor speed is infinitely variable with the slide



Altering Needle Positions

- ▶ touch left button – the needle moves to the left
- ▶ touch right button – the needle moves to the right
- ▶ quick change – hold the button down
- ▶ total of 11 needle positions (5 left, 5 right, 1 center)

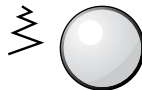

Stitch Width/Length (Multi-function) Knobs

- ▶ to adjust stitch width or length
- ▶ to alter thread tension
- ▶ to alter presser foot pressure
- ▶ to adjust button size or the slit size of the buttonhole
- ▶ to adjust the balance



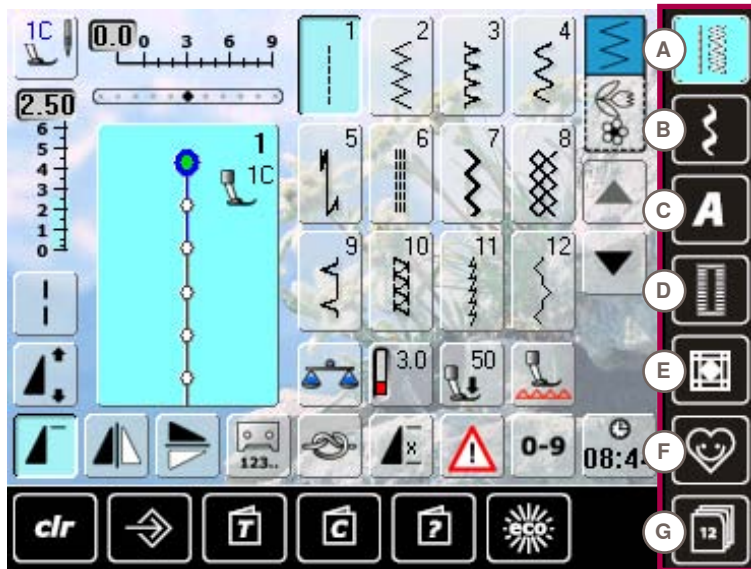

Menu Selection

- A Practical stitches
- B Decorative stitches
- C Alphabets
- D Buttonholes
- E Quilt stitches
- F Personal Program
- G History



System Settings

- H clr - Delete
- I Setup Program
- J Tutorial
- K Creative Consultant
- L Help
- M ECO

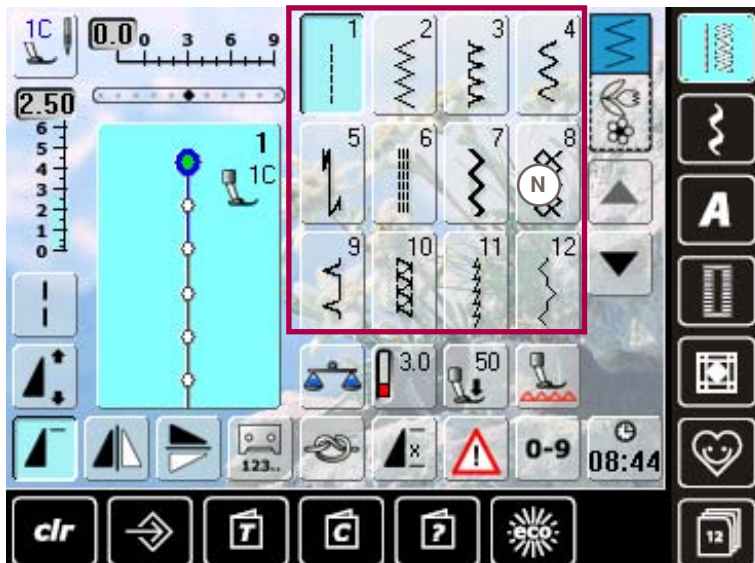

Stitch Display

- N Stitch Pattern selections

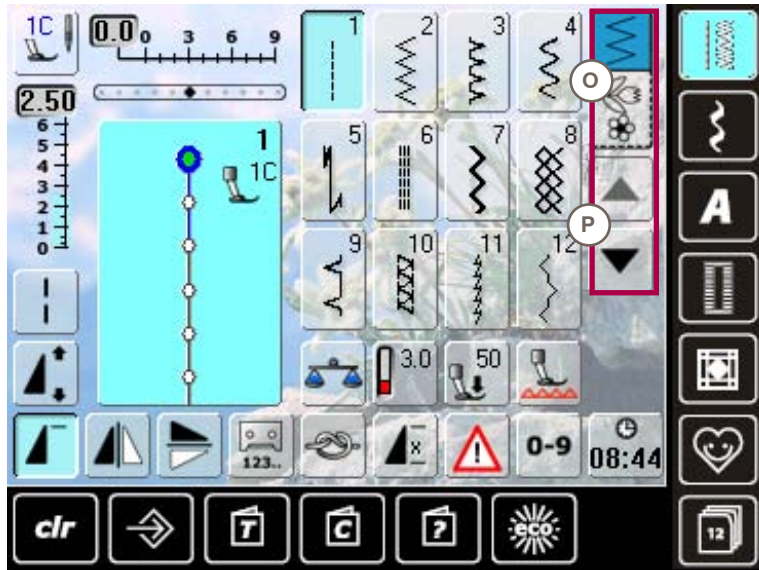

Selection

- O Single/Combi mode
- P Scroll up/down

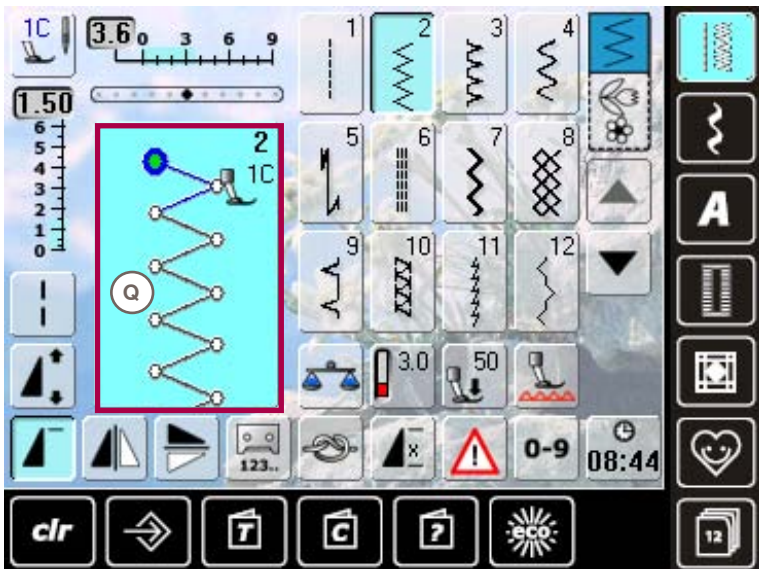

Stitch Altering Area



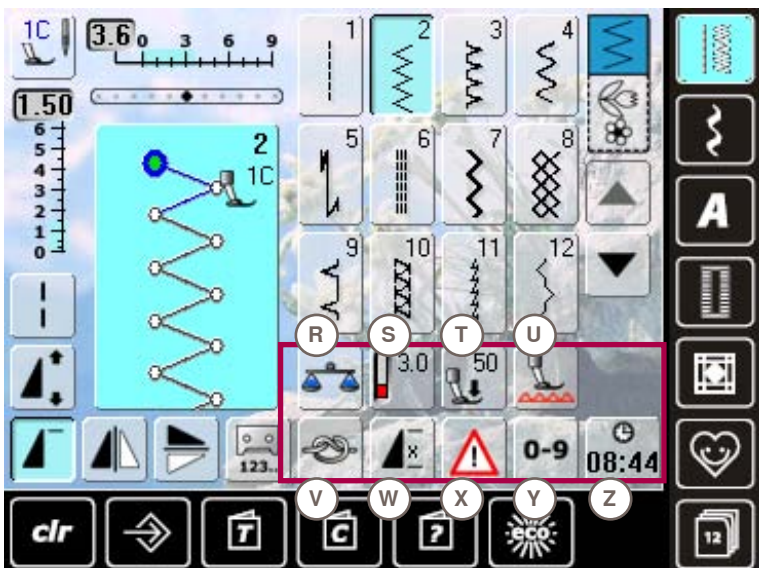













- Q Display of the stitch pattern selected



Functions

- R Balance
- S Thread tension
- T Pressure foot pressure
- U Lower Feed Dog
- V Securing function
- W Pattern repeat
- X Security program
- Y Stitch selection by number
- Z Time/Alarm

Active functions are highlighted in blue, inactive functions are gray.
The multifunction keys are switched off by keeping them pressed a few seconds.

- 
Confirm Selection
 - ▶ activate or confirm change/selection
- 
Leave Active Screen
 - ▶ close application
 - ▶ return to the last active screen
- 
Long stitch
 - ▶ the sewing computer sews every second stitch (max. stitch length 12mm)
 - ▶ can be used for practical and decorative stitches
 - ▶ exception: buttonholes
- 
Mirror Image (Up/Down)
 - ▶ the sewing computer sews the selected stitch pattern in vertical Mirror Image (up/down – determined by the sewing direction)
- 
Mirror Image (Left/Right)
 - ▶ the sewing computer sews the selected stitch pattern in horizontally Mirror Image (left/right – determined by the sewing direction)
- 
Stitch Counter
 - ▶ when the desired length is achieved (e.g. first buttonhole bead or straight stitch), touch the Quick Reverse Button
 - ▶ the display changes to «auto» (for the buttonhole, only after length of second bead is determined by pressing the Quick Reverse Button)
 - ▶ the stitch pattern selected is temporarily programmed
- 
Pattern Extend 2-5x
 - ▶ touch the icon one or more times, the numbers 2-5 appear
 - ▶ stitch integrity is maintained
 - ▶ stitch pattern is extended
- 
Pattern begin
 - ▶ the needle moves to the beginning of a stitch pattern or program
- 
Buttonhole Length Direct Entry
 - ▶ enter buttonhole length via stitch width or stitch length knob. Number in mm
- 
Pattern repeat 1-9x
 - ▶ touch the icon several times, the numbers 1-9 appear
 - ▶ number 1: the sewing computer stops at the end of an individual stitch or stitch combination
 - ▶ numbers 2-9: the sewing computer stops at the end of a stitch or stitch combination after the number of repeats selected
- 
Manual Buttonhole
 - ▶ special screen appears
 - ▶ sew manual buttonhole in 5 or 7 steps (depending on buttonhole type)
- 
Programming Buttonhole Length
 - ▶ icon is automatically highlighted in blue when a buttonhole is selected
 - ▶ set the buttonhole length with the Quick Reverse Button or directly program the length displayed by pressing the icon
 - ▶ function turns inactive after programming the length
 - ▶ if a new length is to be programmed, touch icon again
- 
Feed-dog position
 - ▶ touch the icon «lower feed-dog» = feed-dog is lowered
 - ▶ the lowered feed-dog is shown by the red, flashing symbol
- 
Buttonhole Slit Width
 - ▶ set the buttonhole slit width to between 0.1mm and 2.0mm using the Stitch Width or the Stitch Length Knob
 - ▶ the standard width is 0.6mm
- 
Securing
 - ▶ touch icon before sewing starts = single pattern is secured at the start with 4 securing stitches
 - ▶ touch icon during sewing individual stitches = individual stitches will be secured at the end, the sewing computer stops
 - ▶ program the function within a pattern combination = each individual pattern of the combination can be secured at the start or the end
- 
Multi-function button
 - ▶ only active in combination mode
 - ▶ when selected, a screen with further functions appears
- 
Lettering size in alphabets
 - ▶ when alphabet is selected, the lettering size is 9mm
 - ▶ when the function is selected, «2» is activated and the alphabet is sewn with 6mm lettering size



Combination subdivider (1)

- ▶ each combination or memory folder can be subdivided into several parts
- ▶ only those parts where the cursor is located will be sewn
- ▶ to sew another part, the cursor must be placed in this part



Combination subdivider (2)

- ▶ each combination can be subdivided as desired
- ▶ after stopping, the needle moves to the next part to be sewn



Presser foot indicator

- ▶ number of presser foot recommended is shown for the stitch pattern selected
- ▶ if the presser foot is raised it is indicated with an animation
- ▶ touch the icon
- ▶ screen is opened with further presser foot options



Back Stepping

- ▶ the last 200 needle penetrations of a stitch pattern are retraced, i.e. sewn backwards (see p. 79 on how to select the function)



Save

- ▶ save stitch pattern combinations and lettering



Delete

- ▶ e.g. single stitch pattern, pattern combinations, memory bank contents, stitch pattern in personal program etc.



Balance

- ▶ balance forward and reverse stitches
- ▶ balance dual feed



Stitch selection by numbers

- ▶ select individual stitch pattern by inputting the stitch pattern number



Permanent reverse sewing

- ▶ the sewing computer sews backwards permanently (see p. 79 on how to select the function)



Upper/Lower Case

- ▶ switch from upper case to lower case lettering



File Drawers

- ▶ saved stitches are visible



Thread tension

- ▶ change upper thread tension
- ▶ the respective value is visible in the icon



Presser foot pressure

- ▶ increase or decrease the presser foot pressure using the multifunction knobs
- ▶ the respective value is visible in the icon



Time/Alarm

- ▶ set the current time (hh:mm) in the upper part of the screen using the «+» and «-» icons
- ▶ touch the alarm button in the lower part of the display
- ▶ set the alarm time using the «+» and «-» or the multifunction knobs. A personal message can be input using the keyboard
- ▶ the current time now appears in red numbers



Test-sew first on a piece of the fabric you intend to use for the sewing project.



Security Program

- ▶ when selecting the respective needle icon the stitch width will be limited automatically
- ▶ this prevents the inserted special needle (double needle etc.) from hitting the presser foot or stitch plate = avoiding needle breakage
- ▶ the numbers on the needles represent the distance in mm between the needles
- ▶ by selecting the standard needle icon the standard needle is active again and the stitch width limitation is switched off
- ▶ by selecting the corresponding stitch plate the stitch width is automatically limited, so the inserted standard needle cannot hit the stitch plate
- ▶ the function remains active even when the sewing computer is turned off and on



Single Mode

- ▶ the Single Mode is always active (blue) when turning on the sewing computer and only the selected stitch can be sewn



Combi Mode

- ▶ touch the button
- ▶ the Combi Mode is active (blue) and stitch combinations can be programmed

Entry Screen



The Setup Program enables you to personalize the touch screen according to your own requirements and preferences.

After setting the sewing computer to your personal requirements, all changes made in the Setup Program are saved, even when the sewing computer is switched off. Exceptions from this rule are outlined within the description of the function concerned in each case.



Selection Menu

- 1 Display (screen) settings
- 2 Sewing settings
- 3 Information
- 4 Display (screen) calibration
- 5 Monitoring settings
- 6 Reset basic settings
- 7 Update sewing computer
- 8 Cleaning the sewing computer



Customized alterations are saved even when the sewing computer is switched off. Alterations can be re-programmed at any time.



The System Settings can be changed using the stitch width and stitch length knobs and the «+/-» icons. «Reset» button resets to the basic System Settings.

Display

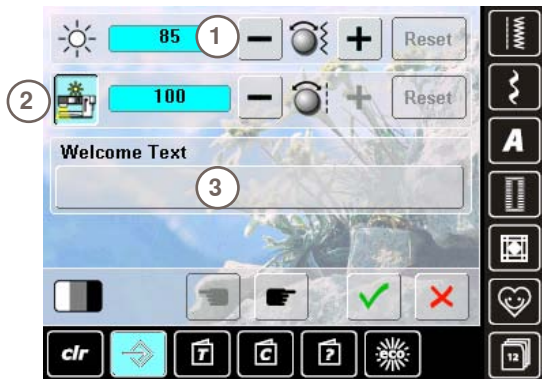

Brightness

- ▶ turn stitch width knob or touch the «+» or «-» icon the brightness 1 of the screen is altered
- ▶ alterations are indicated by the number in the bar and the blue background of the «+» or «-» icons
- ▶ the basic settings are indicated by a dark bar

Sewing Light

- ▶ when icon 2 is active, the sewing light is on
- ▶ when the icon is inactive, the sewing light is off
- ▶ the brightness can be set with the stitch length knob or the «+» or «-» icon

Welcome Text

- ▶ create or change Welcome Text 3
- ▶ space bar is at the bottom of the letter keys
- ▶ welcome text 4 appears in the text icon above the letter keys
- ▶ touch the text icon = text entered is completely deleted



- ▶ text entered is deleted from right to left



- ▶ «ABC» all in upper case (standard)
- ▶ «abc» all in lower case
- ▶ «1,2,3» numbers and mathematical character
- ▶ «Ä À Á», «ä à á» and «@ #» upper and lower special characters



Wallpaper

Select desired screen wallpaper.

- ▶ choose from different images
- ▶ use the scroll icons to browse the wallpaper variants
- ▶ default image = edelweiss

Sewing

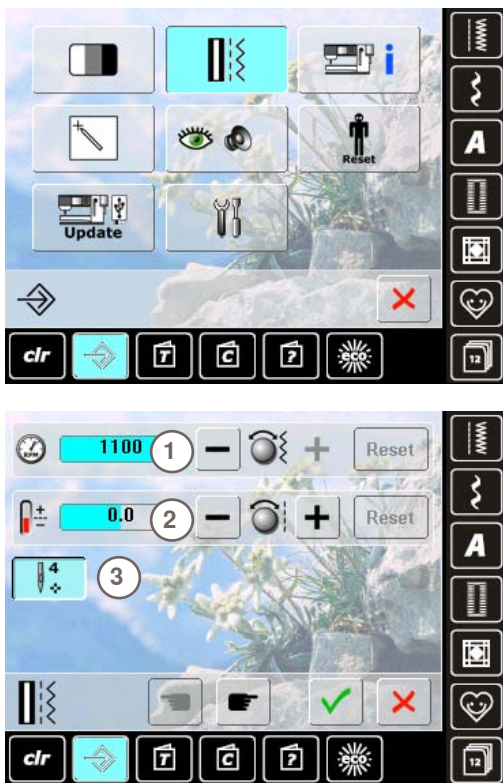

Motor Speed

- ▶ alter maximum sewing speed 1
- ▶ the number in the bar is the stitches per minute; the basic value is indicated by a dark bar

Thread Tension

- ▶ alter the basic setting (0) of the upper thread tension 2 by plus or minus 20%
- 0 = basic settings



The tension alteration affects all stitches and is saved even when the sewing computer is switched off.

Securing stitches on/off

- ▶ function 3 is active = standard
- ▶ if the automatic thread cutter is used to cut the threads, 4 securing stitches will be stitched when resuming sewing
- ▶ function is inactive = no securing stitches will be stitched

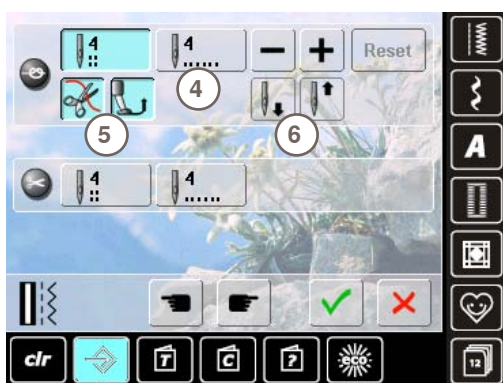

Automatic Securing Program

- ▶ the number and type of the securing stitches can be programmed
- ▶ standard = four securing stitches in the same place
- ▶ select function 4 for forward securing stitches
- ▶ 3-6 securing stitches can be programmed

Automatic Thread Cutter

- ▶ if function 5 is activated, the upper and lower thread are automatically cut after sewing

Raise Presser Foot

- ▶ if function is activated 6 the presser foot is raised after securing
- ▶ if function is not activated, the presser foot stays down

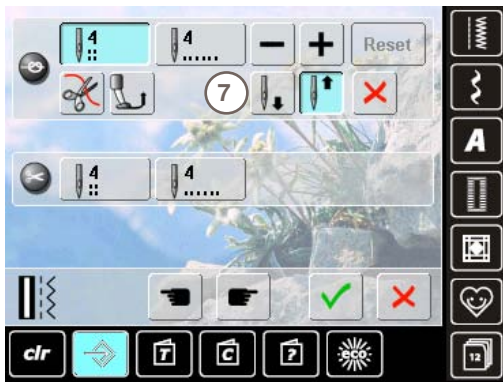

Needle Stop Adjustment

- ▶ if the automatic thread cutter and the «raise presser foot» function are switched off when securing, the needle stop position 7 can be selected
- ▶ standard = sewing computer stops with the needle up while the presser foot stays down after securing
- ▶ touch «Needle down» icon
- ▶ the sewing computer stops with the needle down after securing



Automatic Thread Cutter and Securing Stitches

- ▶ the number and type of securing stitches before the thread is cut can be programmed
- ▶ touch function 8 for securing stitches in place or function 9 for forward securing stitches
- ▶ two to six securing stitches can be programmed
- ▶ standard = no securing stitches programmed



Presser foot position when needle stop down

- ▶ with activated icon 1, the presser foot remains down when the sewing computer stops
- ▶ with activated icon 2, the presser foot is raised enough to pivot the fabric (hover position)
- ▶ with activated icon 3, the presser foot is raised into its highest position

Hover position of presser foot

- ▶ the stitch width and stitch length multi-function knobs can be used to set the clearance from 0mm to 7mm in maximum (standard clearance is 2mm)
- ▶ the set value, i.e. the clearance between the fabric and the presser foot, is displayed in icon 4

Information



Needle Chart

- ▶ select the needle inserted
- ▶ when the sewing computer is switched on, the needle selected will be displayed
- ▶ touch the arrow icon to scroll through to the needle types



Language

- ▶ scroll through the languages by touching the arrow icons and select the language required



Dealer Details

- ▶ by pressing the respective gray bar the following information about your BERNINA dealer can be entered:
 - ▶ store name
 - ▶ last name, first name
 - ▶ telephone number
 - ▶ website or e-mail address



Version

- ▶ the current versions of the sewing computer can be seen
- ▶ the total number of stitches and the number of stitches sewn since the last servicing by the BERNINA dealer are displayed



Service Data

Service data of the actual condition of your sewing computer can be saved on a USB stick and sent to your authorized BERNINA dealer:

- ▶ insert the USB stick into your sewing computer
- ▶ touch «LOG»
- ▶ after the data is saved remove the USB stick

Screen Calibration

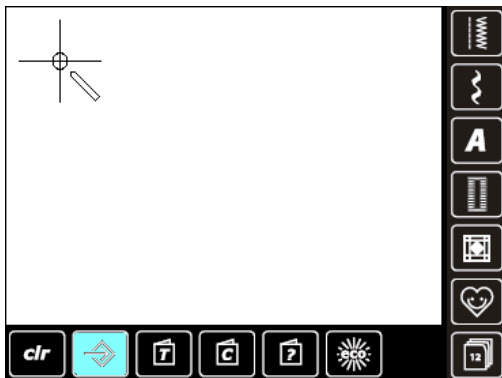
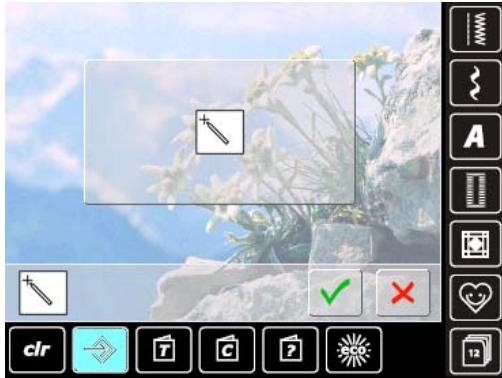

The calibration screen can also be opened this way:

- ▶ switch sewing computer off (to «0»)
- ▶ touch the two needle positioning buttons on the front panel and keep them pressed
- ▶ switch sewing computer on (to «I») and as soon as the calibration screen is opened, release the two buttons

- ▶ touch the calibration icon
- ▶ another screen appears

- ▶ with touch pen touch the center of the cross. The cross moves to the next position
- ▶ repeat this until all three positions shown are calibrated
- ▶ touch **✓** to save settings

Monitoring



Audio System

- ▶ sounds can be activated or deactivated 1

Selecting Stitch Pattern/Function/BSR

- ▶ stitch patterns and function selection 2 can be confirmed acoustically
- ▶ touch the speaker icon until you hear the desired sound
- ▶ there are six different sounds to choose from
- ▶ this icon is blue and the sound is indicated by a number (1-6)
- ▶ the sounds for functions (center) and the sound for quilting with BSR (bottom) can be activated or deactivated in the same way
- ▶ deactivation is the last option shown when scrolling through the different sounds



Monitoring Functions

The following monitoring functions can be activated or deactivated:

Upper thread indicator

Lower thread indicator

Optimum interlocking of upper and lower thread

Sewing without thread

- ▶ blue with open eye = function active
- ▶ gray with closed eye = function inactive
- ▶ the sound type for the monitoring functions is set in the audio settings for function



Sewing without thread

- ▶ don't thread the sewing computer with upper thread (or remove it entirely)
- ▶ press the large field on the left
- ▶ sewing without thread is activated
- ▶ the other three monitoring functions are deactivated and disappear
- ▶ the automatic thread cutter is deactivated
- ▶ selecting another presser foot or switching the sewing computer off deactivates the function

Reset/Delete User Data



Choose from the following options by pressing the Reset button:

- 1 **Reset Settings**
- 2 **Delete User Data**

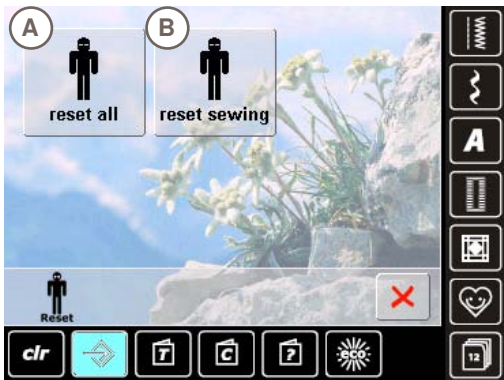
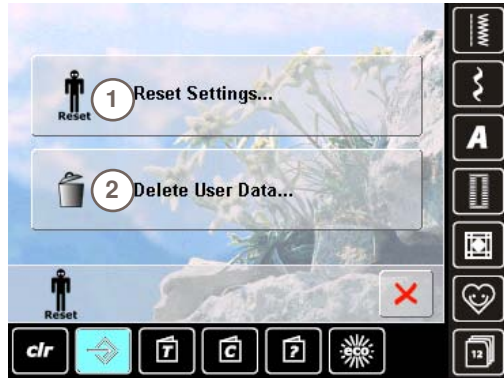

Reset Settings

Choose from the following options by pressing bar 1:

- A **Reset All**
- B **Reset Sewing**

- ▶ touch the bar whose settings are to be returned to the basic settings
- ▶ confirm with ✓
- ▶ the previous screen appears
- ▶ touch ✗ until the selection menu appears



Delete User Data

Pressing bar 2:

- C **Sewing «Personal Program»**

- ▶ touch the bar
- ▶ confirm with ✓
- ▶ the data is deleted and the previous screen appears
- ▶ touch ✗ until the selection menu appears



Update



Updating

- ▶ insert BERNINA USB stick with the new software version
- ▶ touch «Update»
- ▶ touch «Update» again to start the process
- ▶ it is then determined if:
 - ▶ a BERNINA USB stick is inserted
 - ▶ there is enough free space available (at least 10MB)
 - ▶ the correct software version is on the stick
- ▶ the data and settings are accepted
- ▶ if the update was successful, a message appears and the sewing computer is ready to sew again
- ▶ if the update cannot be started or if there are problems during the update process, an error message appears



Do not remove the BERNINA USB stick until there is a message which indicates the end of the update.

Cleaning the sewing computer



Cleaning

- ▶ clean the sewing computer according to the instructions
- ▶ touch field 1
- ▶ the thread catcher of the automatic thread cutter moves to the right
- ▶ carefully remove any thread remnants with the tweezers
- ▶ touch field 3
- ▶ the automatic thread cutter is re-initialized and then ready for operation



Cleaning the needle threading mechanism

- ▶ clean the needle threading mechanism according to the instructions and animation



Lubricating the hook

- ▶ lubricating the hook according to the instructions and animation



Calibrating buttonhole foot no. 3A

- ▶ attach buttonhole foot no. 3A
- ▶ press the Start-/Stop button (green) on the head frame
- ▶ the buttonhole foot will move forward and backward
- ▶ buttonhole foot will calibrate and sewing computer will indicate that the calibration has been successful
- ▶ the buttonhole foot is now set for this particular sewing computer, and should only be used with this one

Overview of Topics



The Tutorial provides information and explanations about the different areas of sewing.



- | | | | |
|---|--------------------------------|----|---------------------|
| 1 | Threading | 6 | Freehand system FHS |
| 2 | Needles | 7 | Miscellaneous |
| 3 | Presser foot | 8 | Buttonholes |
| 4 | BERNINA Stitch Regulator (BSR) | 9 | Quilting |
| 5 | Troubleshooting | 10 | Techniques |



- ▶ select desired topic, e.g. presser foot
- ▶ topic overview about the presser foot appears
- ▶ select desired topic, e.g. changing the presser foot



- ▶ information on the desired topic is shown
- ▶ use the stitch width or stitch length knob, the finger or the touchscreen pen to scroll through the text in the screen
- ▶ animations can be stopped or replayed by touching the icon in the bottom right corner
- ▶ touch the animation with your finger or the touchscreen pen and travel to the right or left
- ▶ the playing of the animation is controlled manually now
- ▶ touch the animation again to switch back to automatic playing mode



- ▶ use these two icons to go to the previous or next page
- ▶ touch **X** to close the Tutorial screen
- ▶ the last active screen appears



The Creative Consultant provides information and help with various sewing techniques. After selecting the fabric and the desired sewing technique suggestions for suitable needles, presser feet etc. are displayed. Presser foot pressure and upper thread tension are set automatically.



Fabric Types

- ▶ the most commonly used fabric types are listed in three categories
- ▶ select the desired fabric type e.g. Silk
- ▶ if the material used is not shown, select a similar fabric



Overview of Sewing Techniques

- ▶ the possible sewing techniques appear on selecting a fabric type
 - ▶ Seams
 - ▶ Overcasting
 - ▶ Blindhem
 - ▶ Buttonholes
 - ▶ Zippers
 - ▶ Decorative stitching
 - ▶ Machine quilting
 - ▶ Free-motion stitching
 - ▶ Appliqué
- ▶ select the desired sewing technique, e.g. buttonhole
- ▶ if the desired technique cannot be found on this list, select a related technique



Recommendations

- ▶ recommendations for the fabric selected and the desired technique are shown
- ▶ links to the respective topics in the Tutorial are displayed
- ▶ additional information regarding engaging links for more information

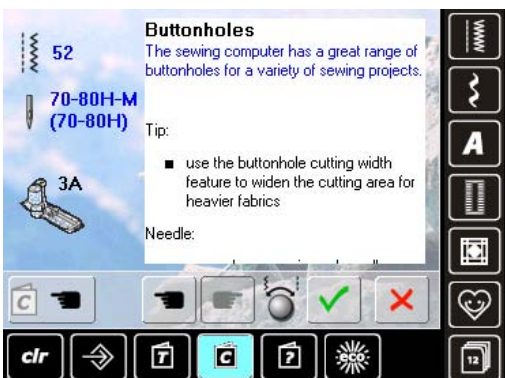

- ▶ select buttonhole link
- ▶ information on buttonholes appears
- ▶ use the stitch width or stitch length knob to scroll within the text



- ▶ the Creative Consultant home screen is displayed
- ▶ select to display the screen containing the suggested stitch pattern
- ▶ select to close the Creative Consultant screen
- ▶ the last active screen appears

General



The Help Program contains information about individual stitch patterns and functions in the screen. No matter which screen is displayed, the help feature for stitches and functions of the screen can be opened.

- ▶ touch the «?» icon
- ▶ select the desired stitch pattern or the desired function



Stitch Pattern

This screen displays the following information:

- ▶ name of the stitch pattern
- ▶ suitable materials
- ▶ main areas of application

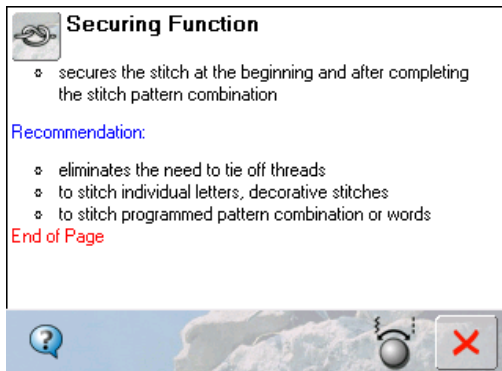

Functions

This screen displays the following information:

- ▶ function name
- ▶ function explanation
- ▶ main areas of application

- ▶ select **X** to close the Help screen
- ▶ the last active screen appears

Balance Description



The sewing computer is tested and optimally set before it leaves the factory. Different fabrics, threads, stabilizers and interfacings can affect programmed stitches so that they are not sewn out properly.

These effects can be corrected with the electronic Balance so that the stitch formation can be adjusted where necessary to suit the fabric.

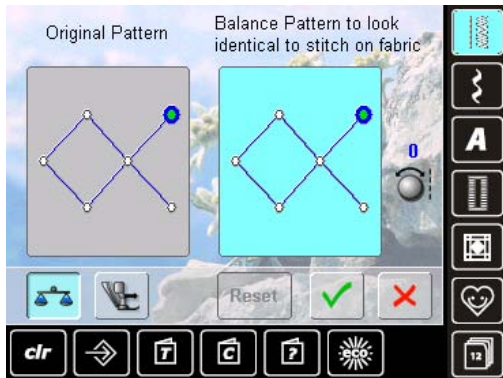

Practical and Decorative Stitches

- ▶ in the left portion of the screen the stitch is displayed in its original form (as programmed)
- ▶ in the right portion of the screen the alterations made are directly visible
- ▶ the corrections can be made while sewing (with opened screen)

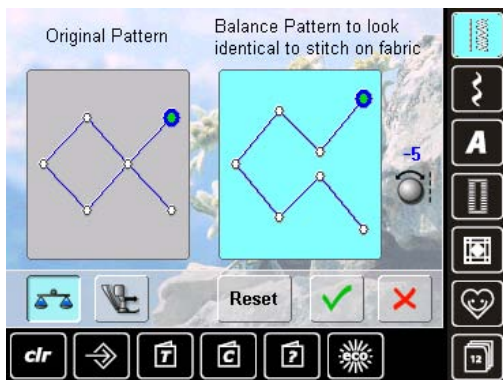

Corrections

- ▶ the stitch sewn on the fabric (e.g. the Honeycomb stitch) opens up and it does not look correct:
 - ▶ turn the stitch length knob until the stitch in the right portion of the screen is identical with the stitch on the fabric

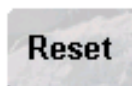
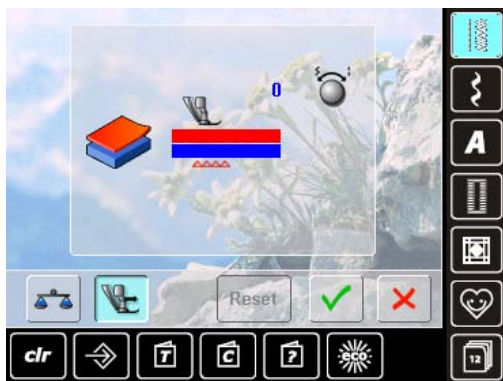

BERNINA Dual Feed

- ▶ standard = the fabric is evenly fed by the dual feed and the feed-dog together
- ▶ Top layer of fabric is fed too slowly = «becomes» longer compared to the bottom layer
- ▶ turn the stitch width or stitch length knob clockwise to speed up the feeding of the top layer of fabric – evening out the feeding speed difference between the two layers
- ▶ Top layer of fabric is fed too quickly = «becomes» shorter compared to the bottom layer
- ▶ turn the stitch width or stitch length knob counterclockwise to slacken the feeding speed of the top layer of fabric – evening out the feeding speed difference between the two layers

- ▶ changes made to the selected pattern or the dual feed are deleted
- ▶ select to save the changes and close the screen
- ▶ select to close the screen; the original settings are kept

Presser Foot Pressure Settings

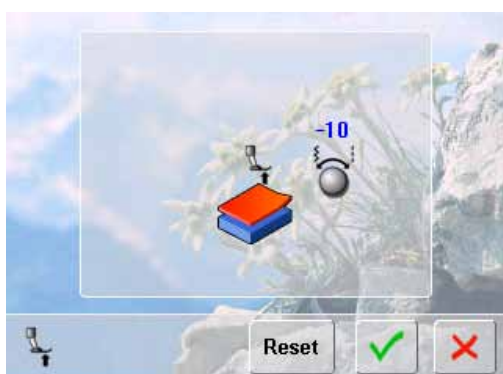
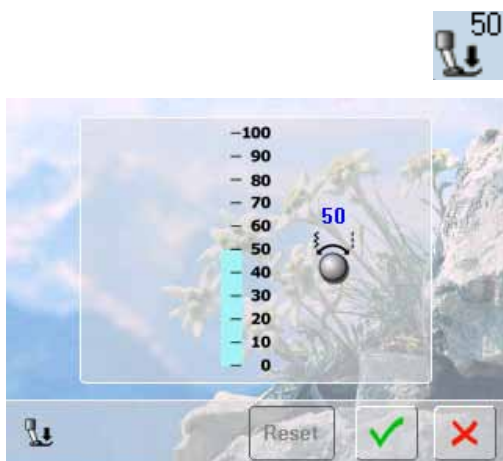

Adjusting the Pressure

- ▶ the presser foot pressure scale appears on touching the «Presser Foot Pressure» icon
- ▶ turning the stitch width or stitch length knob to the left or the right decreases or increases the presser foot pressure

- ▶ with thick or multilayered fabric (e.g. when quilting) turn one of the multifunction knobs to the left to decrease the pressure (minus value)
- ▶ the presser foot is slightly raised, making it easier to move the fabric
- ▶ touch to save the setting
- ▶ touch «Reset» to reset to the basic setting

ECO Description



When work is interrupted for longer periods, the sewing computer can be put into energy-saving mode.



- ▶ touch the button
- ▶ screen goes dark
- ▶ power consumption is reduced and the sewing light turned off
- ▶ this mode also acts as a child safety feature
- ▶ nothing can be selected on screen (buttons are locked), and the sewing computer cannot be started
- ▶ touch button again = sewing computer is ready for use



Main Stitch Categories

Stitch Patterns

Selection

- via Screen
- by Stitch Number
- Selecting a Presser Foot

Customizing Stitch Patterns

- Altering Stitch Width and Stitch Length
- Altering Needle Position
- Securing with Quick Reverse Button on Head Frame
- Temporary Altered Stitch Memory For All Stitch Types and Materials
- Resetting to the Factory Setting

Practical Stitches

Practical Stitches Description

Decorative Stitches

Decorative Stitches Description

Tapering

- Setting

Combining with Functions

- Mirroring Decorative Stitches
- Long Stitch Function
- Pattern Extend
- Pattern Extend with Long Stitch
- Double, Triple or Wing Needle

Combi Mode

- Combining Practical and Decorative Stitches

Alphabets

Alphabets Description

Lettering

Perfect Stitch Formation

Combining Lettering

- Alphabets
- Correcting Combinations

Combining Lettering and Functions

- Select Lower Case
- Change Size

Buttonholes

Buttonholes Description

Combining with Functions

- Manual 5- or 7-Step Buttonhole

Balance

Automatic

- Direct Entry Length
- Button Measurement

56	Programming	72
	Automatic Buttonhole	72
	Standard and Stretch Buttonhole	72
	Round and keyhole Buttonholes	72
	Hand-look Buttonhole	73
	Stitch Counter Buttonhole	73
	All Buttonhole Types	73
57	In Long-Term Memory	74
57	Button Sew-On Program	74
57	Eyelet Program	75
	Sewing Eyelets	75
	Punching Eyelets	75
58	Quilt Stitches	76
58	Quilt Stitches Description	76
60	Personal Program	77
60	Creating a Customized Stitch Menu	77
61	Preparing Stitch Patterns	77
	Personal Screen	77
62	Altering Stitch Patterns	78
62	Deleting Stitch Patterns	79
	Special Screen	79
64	History	80
64	History Description	80
65	Long Term Memory	81
65	Long Term Memory Description	81
65	Creating Stitch Combinations	81
	Programming and Saving	81
66	Deleting Stitch Patterns	82
	Deleting patterns in steps	82
	Deleting a Combination	82
	Opening Empty File Drawers	82
67	Drawer Content at a Glance	83
67	Opening a Saved Stitch Combination	83
68	Correcting a Stitch Combination	84
	Inserting Stitch Patterns	84
	Altering a Stitch Combination	84
	Mirroring Entire Combinations	84
	Combination Subdivider 1	85
	Combination Subdivider 2	85
70	Deleting a Stitch Combination	85
	Overwriting	85
	Deleting	85

Selection

via Screen

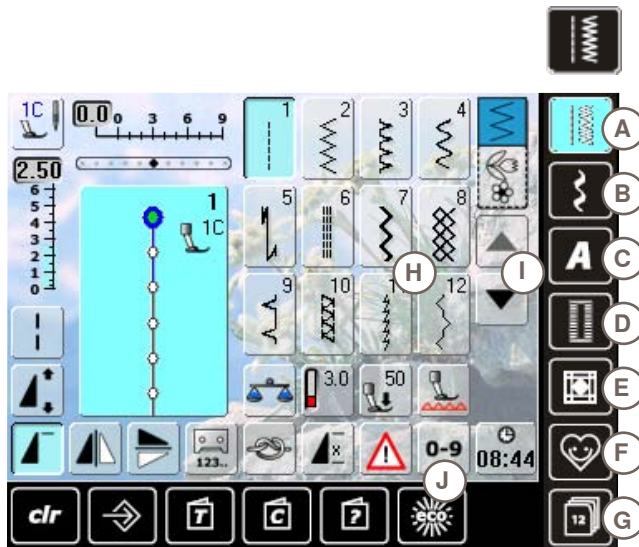

▶ select from main categories A - G

- A Practical stitches
- B Decorative stitches
- C Alphabets
- D Buttonholes
- E Quilt stitches
- F Personal Program
- G History

▶ the available stitch patterns appear in display section H

▶ select desired stitch pattern

▶ scroll I to view all other stitch patterns of the category

by Stitch Number



Input

▶ select stitch pattern by entering the number after touching the icon J

▶ number keys 1 appear in display section H

▶ the selected stitch number appears 2

▶ 3 to delete the previously entered number

▶ the entire number is deleted if you touch 2

▶ confirm entry 4

Cancel

▶ back to the previous screen without selecting stitch pattern 5



An invalid stitch number will be indicated in bar 2 with 3 question marks.

Selecting a Presser Foot



▶ any selected stitch pattern appears together with the optimum presser foot in the stitch altering area

▶ attach the recommended presser foot

▶ touch the «Presser Foot Selection» icon top left in the screen

▶ in the opened presser foot category, select the icon that shows the attached presser foot, and confirm ✓. As an alternative, attach one of the options shown in the lower portion of the screen, select the respective presser foot icon and confirm ✓

▶ the attached presser foot appears in the «Presser Foot Selection» icon

▶ depending on the presser foot attached, the presser foot category may change



It is **IMPORTANT** to select the attached presser foot in the respective presser foot category to enable the sewing computer to recognize it and to activate the respective safety settings.

Customizing Stitch Patterns

A stitch pattern can be individually altered according to the fabric and the application. The adjustments described here are applicable for all practical and many decorative stitches.

Altering Stitch Width and Stitch Length



- ▶ alter stitch width and stitch length using the knobs
- ▶ stitch width and stitch length can be altered while sewing

Altering Needle Position

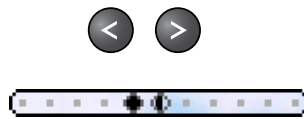

- ▶ touch the relevant button to move the needle position. To move quickly hold the button down
- ▶ 11 needle positions in total (5 left, 5 right, 1 center)
- ▶ can be altered while sewing

Securing with Quick Reverse Button on Head Frame



- ▶ secures the beginning and end of the seam
- ▶ touch the Quick Reverse button = sewing computer sews in reverse (backstepping)
- ▶ release the Quick Reverse button = sewing computer sews forwards

Temporary Altered Stitch Memory

For All Stitch Types and Materials

- ▶ altered stitch length, stitch width and needle position are automatically saved as well as functions like mirror image
- ▶ sew an altered stitch (e.g. zigzag stitch)
- ▶ select another stitch and sew (e.g. straight stitch)
- ▶ when retrieving the individually altered zigzag stitch, the alterations are retained
- ▶ the temporary altered stitch memory can contain any number of stitch patterns



The altered stitch memory can hold as many stitch alterations as needed:

- ▶ Stitch length
- ▶ Stitch width
- ▶ Needle position
- ▶ Pattern extend
- ▶ Mirror images
- ▶ Long stitch function
- ▶ Thread tension
- ▶ Balance
- ▶ Pattern repeat 1-9x

Resetting to the Factory Setting

- ▶ option 1: touch «clr» button
- ▶ option 2: restore stitch width and stitch length by touching the stitch width/stitch length bar (or manually by turning the knob); reset other functions manually
- ▶ option 3: switch off sewing computer

Practical Stitches Description

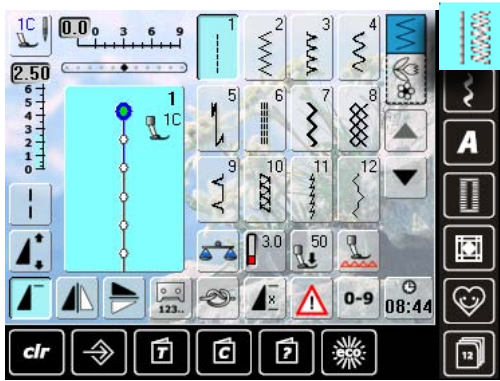

- ▶ touch the «Practical stitches» icon
- ▶ 12 practical stitches are visible in the display
- ▶ further practical stitches are visible by scrolling

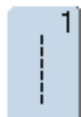

1 Straight stitch
For non-elastic fabric; all straight stitch work, such as seams, topstitching, sewing in a zipper



2 Zigzag
Zigzag work such as overcasting edges, attaching elastic and lace

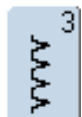

3 Vari-Overlock
For fine jerseys, stretch overlock seams, hems and stretch seams

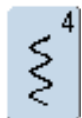

4 Running Stitch
Most types of fabric. Mending, patching, reinforcing seams, sewing over decorative threads

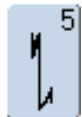

5 Securing Program
For all fabrics; secures the beginning and end of seams by straight stitching

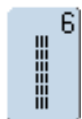

6 Triple Straight Stitch
Reinforced seams in firm fabrics, visible hems and seams



7 Triple Zigzag
Reinforced seams in firm fabrics, visible hems and seams, couching, decorative stitching

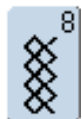

8 Honeycomb Stitch
Most types of interlock and smooth fabrics, visible seams, hems, linens and some types of mending

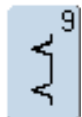

9 Blindstitch
For most types of fabric; blind hems; shell edging in soft jerseys and fine fabrics; decorative seams



10 Double Overlock
For all types of knit; overlock stitch, finished edge



11 Super Stretch Stitch
For highly elastic fabrics. Highly elastic open seam for all types of clothing



12 Gathering Stitch
For most fabrics. Gathering with shirring elastic. Butted seams (edge-to-edge) and decorative stitches



13 Stretch Overlock
For medium weight knits, toweling and firm wovens; overlock seam, flat joining seams



14 Jersey Stitch
For jersey fabrics; visible seams in lingerie, sweaters; mending jerseys



17 Lycra Stitch
For lycra fabrics, flat joining seams, hems, reinforcing seams on underwear



21 Basting Stitch
Basting seams, hems, etc. temporarily



22 Darning Program
Automatic darning of fine to medium weight fabrics



24 Bartack Program
Reinforcing pocket openings, belt loops etc.



Bartack Program

Reinforcing pocket openings, belt loops, securing zippers and seam ends



Small fly stitch

For fine to medium weight fabrics; reinforcing pocket openings, zippers and slits

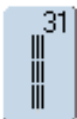

Triple Straight Stitch with Long Stitch

Reinforced seams in heavy fabrics, visible seams and topstitching

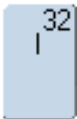

Single Straight Stitch

As a connecting stitch between two individual decorative stitch patterns. Typically used in Combi-Mode

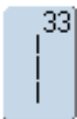

Three Single Straight Stitches

As a connecting stitch between two individual decorative stitch patterns in a combination

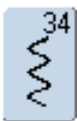

Darning Stitch

Use for darning in conjunction with the Permanent Reverse function

Decorative Stitches Description

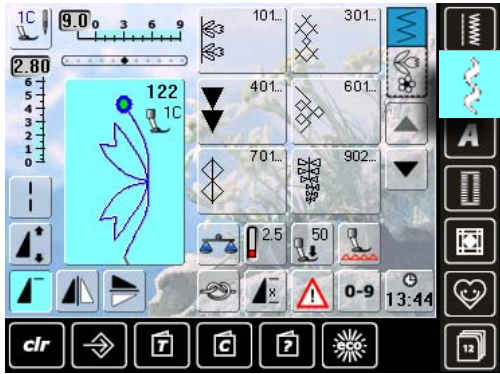

- ▶ touch the «Decorative stitch» button
- ▶ an overview of the categories appears in the display
- ▶ touch a button and the desired category is activated
- ▶ select a stitch pattern

Application

Depending on the type of the fabric, simple or more complex decorative stitches should be selected to best suit the fabric

- ▶ simple decorative stitches in straight stitch design formation are particularly appropriate for light weight materials (e.g. decorative stitch no. 101)
- ▶ simple to more complex decorative stitches - programmed with triple straight stitch or with a few satin stitches - are particularly suitable for medium weight fabrics (e.g. decorative stitch no. 135)
- ▶ more complex decorative stitches - programmed with satin stitches - are well suited to heavy weight fabrics (e.g. decorative stitch no. 401)



Cat. 100 = Florals
 Cat. 300 = Cross stitches
 Cat. 400 = Satin stitches
 Cat. 600 = Ornamental stitches
 Cat. 700 = Heirloom stitches
 Cat. 900 = Novelty
 Cat. 1100 = Tassel stitches
 Cat. 1400 = Tapering stitches



Perfect Stitch Formation

- ▶ use the same thread weight for upper and lower threads
- ▶ for a perfect stitch formation reinforce the fabric piece on the wrong side using stabilizer
- ▶ use an additional, water-soluble stabilizer on the right side of pile or longfiber fabrics (e.g. wool, velvet etc.) which can be easily removed after sewing

Tapering

Setting



- ▶ tapering is a technique in which the stitch patterns come to a point at the beginning and end
- ▶ four different angles are pre-programmed; you can set the angle yourself on the fifth page
- ▶ select stitch no. 1401



- ▶ the tapering screen appears
- ▶ the first segment (1) is active
- ▶ segment (1) and (3) have a programmed length; you can set the length of section (2) yourself

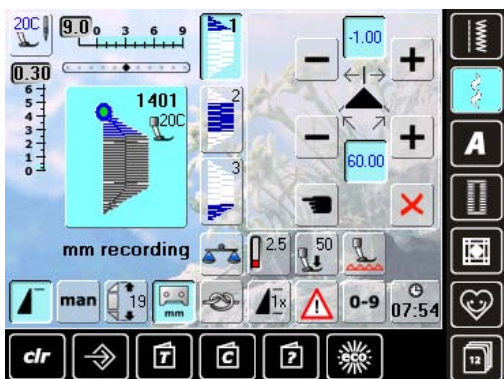

- ▶ use the top «+» and «-» buttons to move the tips of the pattern from -1.00 (far left) to 1.00 (far right)
- ▶ standard setting = -1.00
- ▶ touch the active field in the center to place the tips in the center of the pattern (0.00)
- ▶ use the bottom «+» and «-» buttons to set the angle of the tips between 0.00° and 90.00°
- ▶ standard setting = 60.00°
- ▶ touch the active field in the center to set the angle to 45.00°



Programming the Length of Section 2

- ▶ field is blue (active) when a tapering pattern is selected
- ▶ sew the first section
- ▶ use the Quick Reverse button on the head frame to set the length of section 2
- ▶ once the length is programmed, the field is turned off (inactive, gray)
- ▶ after the second section is programmed, the third section is automatically sewn and the sewing computer stops
- ▶ to program a new length, reselect the field



Programming the Length of Section 2 by Entering mm

- ▶ touch the icon
- ▶ program the length with the stitch width or stitch length knob
- ▶ sew the stitch pattern
- ▶ all three sections are automatically sewn and the sewing computer stops
- ▶ to program a new length, reselect the field



Manually Setting the Length of Section 2

- ▶ touch the icon
- ▶ sew first section
- ▶ use the Quick Reverse button on the head frame to set the length of section 2
- ▶ the third section is automatically sewn and the sewing computer stops
- ▶ the length is not programmed, and must be reset each time a new tapered pattern is started



Selecting the Tapering Angle

- ▶ touch the symbols to select another angle



Closing the Tapering Screen

- ▶ touch the icon
- ▶ the tapering screen is closed and the tapering patterns appear

Combining with Functions

Amazing effects can be created by combining decorative stitches and functions.

Mirroring Decorative Stitches

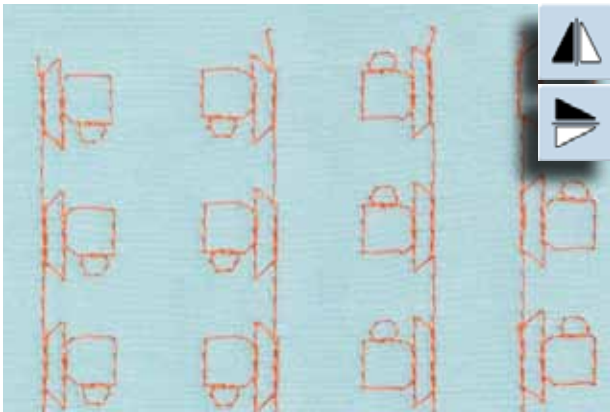

- ▶ touch Mirror Image (left/right) function
- ▶ the stitch pattern is mirrored left/right
- ▶ touch Mirror Image (up/down) function
- ▶ the stitch pattern is mirrored in the sewing direction, up/down
- ▶ touch both mirror functions simultaneously
- ▶ the stitch pattern is mirrored vertically and horizontally

Long Stitch Function

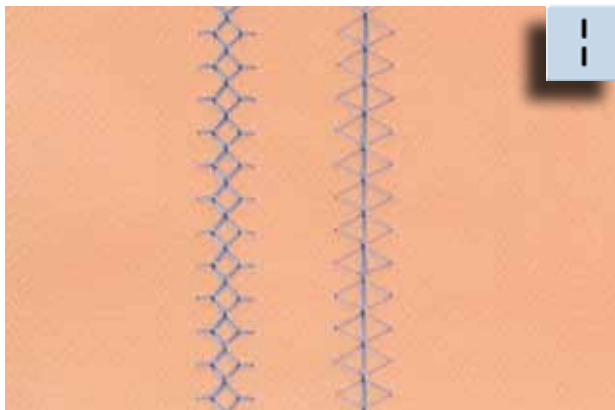

- ▶ touch Long Stitch function
- ▶ the sewing computer sews every second stitch in the stitch sequence

Pattern Extend

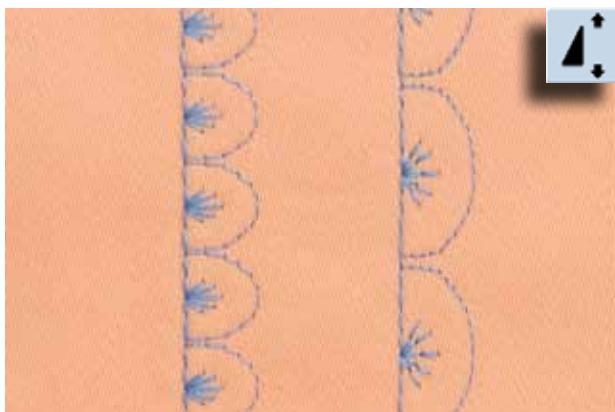

- ▶ touch the Pattern Extend function once or several times
- ▶ the stitch pattern selected is extended (i.e. stretched) 2 – 5 times, while retaining the consistency of the stitch
- ▶ some stitch patterns have a limited extension capability and cannot be extended 3 – 5 times

Pattern Extend with Long Stitch



- ▶ touch Pattern extend function one or more times
- ▶ additionally touch the Long Stitch function

Double, Triple or Wing Needle

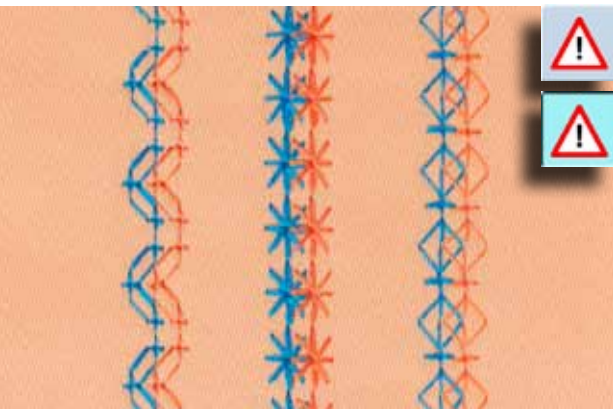

- ▶ after inserting the special needle, activate the needle limitation in the Security Program
- ▶ when selecting the stitch pattern, the stitch width is automatically limited to match the needle selected
- ▶ the best effects are achieved with simple stitch patterns



Security Program

- ▶ icon must be manually reset to deactivate
- ▶ security remains engaged after sewing computer is turned off

Combi Mode



- ▶ select Combi Mode
- ▶ Combi Mode is opened, allowing you to create pattern combinations

Combining Practical and Decorative Stitches



- ▶ select desired stitch
- ▶ the stitch appears in the Stitch Altering Area
- ▶ select next stitch
- ▶ continue in this manner until the desired combination is complete
- ▶ correcting in a combination, see page 84
- ▶ saving a combination, see page 81



Complete combination mirrored sideways

- ▶ touch the «Multifunction» icon
- ▶ touch the «Mirror image (left/right)» icon
- ▶ the whole combination is mirrored left/right

Add the Securing function

There are various options for securing stitch patterns automatically:

- ▶ touch securing function before starting to sew = pattern combination is secured at the beginning
- ▶ to program the securing function within a pattern combination = the stitch patterns are secured accordingly



Most of the practical and decorative stitches can be combined. With the exception of these special programs:

Securing programs

- ▶ No. 5, No. 1324

Basting stitch

- ▶ No. 21

Darning program

- ▶ No. 22

Bartacks

- ▶ No. 24, No. 25

Fly stitch

- ▶ No. 27

Stitch programs in the buttonhole category:

- ▶ No. 51-63

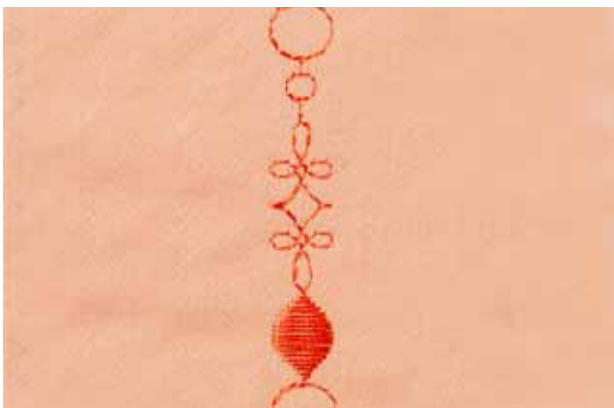

Example of a Stitch Pattern Combination

- ▶ touch stitch pattern no. 407 once
- ▶ touch stitch pattern no. 607 once
- ▶ touch stitch pattern no. 750 once
- ▶ sew combination, the patterns alternate continuously



Example of a Stitch Pattern and Function Combination

- ▶ touch stitch pattern no. 427 once
- ▶ touch stitch pattern no. 402 once and activate «left/right Mirror Image» function
- ▶ sew the combination, the patterns alternate, original and mirrored

Alphabets Description

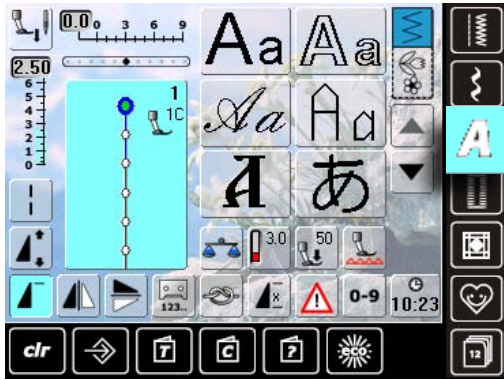

- ▶ 8 different alphabets are available
 - ▶ Block
 - ▶ Double Block
 - ▶ Script (Italics)
 - ▶ Quilting Text
 - ▶ Cyrillic
 - ▶ Hiragana
 - ▶ Katakana
 - ▶ Kanji
- ▶ each of these alphabets can be sewn in two different sizes and in lower case (except Cyrillic, Hiragana, Katakana and Kanji)

Lettering

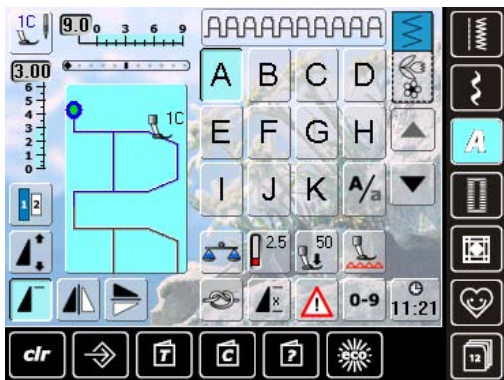

- ▶ all capital letters, numbers, punctuation marks and special characters can be viewed using the arrow icons

Perfect Stitch Formation

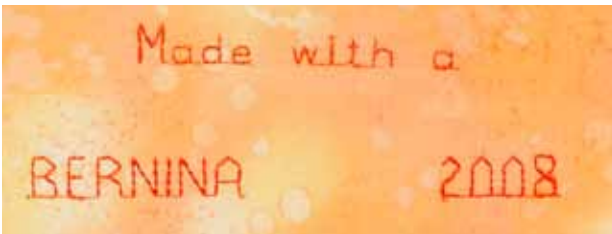

- ▶ use the same thread color for upper and lower threads
- ▶ use stabilizer on the wrong side of the fabric to reinforce sewing project
- ▶ use additional, water-soluble stabilizer on the right side of pile or longfibre fabrics (e.g. wool, velvet etc.)
- ▶ for lightweight fabrics more simple lettering types are suitable (programmed with straight stitches) such as double block letters

Combining Lettering

Alphabets

- ▶ individual letters and rows of the same letter of the same alphabet are sewn in Single Mode
- ▶ letters for names, addresses, words, etc. are combined and sewn in Combi Mode

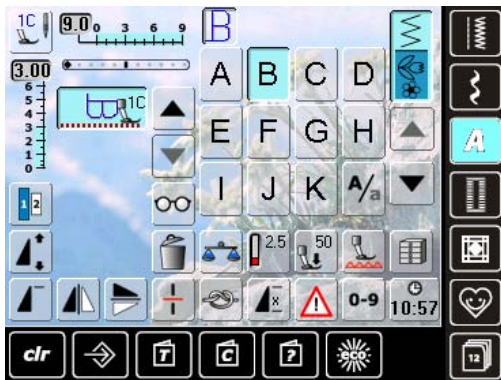

Combining Letters

- ▶ open Combi Mode
- ▶ select desired letter
- ▶ letter appears in Stitch Altering Area and on bar above Alphabet menu
- ▶ cursor is below the letter



- ▶ select next letter by touching required button
- ▶ second letter appears in Stitch Altering Area, etc.

Correcting Combinations



Inserting Letters

- ▶ a letter is always inserted above the cursor
- ▶ cursor must be scrolled up (arrow) to insert an additional letter at the beginning of lettering
- ▶ activate desired place by selecting required letter in Stitch Altering Area or scroll to it
- ▶ select new letter
- ▶ letter is inserted above cursor

Deleting Letters

- ▶ a letter is always deleted above the cursor
- ▶ activate desired place by selecting required letter in Stitch Altering Area, or scroll to it
- ▶ touch «Delete»
- ▶ letter is deleted

- ▶ saving and deleting combinations see pages 81 – 85

Combining Lettering and Functions

Select Lower Case



- ▶ touch the «Upper Case/Lower Case» icon
- ▶ the lower case «a» is highlighted in black, the lower case is activated
- ▶ touch the «Upper Case/Lower Case» icon again, the capital «A» is in black
- ▶ upper case is activated again

Change Size



- ▶ touch the «Alphabet Size» icon; number 2 is highlighted blue
- ▶ the letter is reduced to approx. 6 mm
- ▶ touch «Alphabet Size» again; larger size is activated again (number 1 is highlighted blue)



More functions are described in the chapter «Combining Decorative Stitches with Functions», pages **62 – 63**.

Creating Combinations, see page **81**.

Buttonholes Description

Buttonholes are practical closures which can also be used for decorative purposes. All buttonholes can be sewn and programmed in different ways.

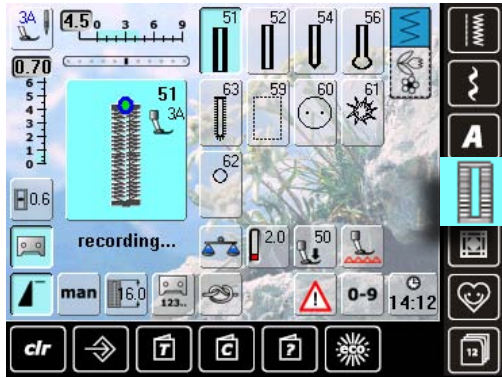

- ▶ touch the «Buttonhole» button
- ▶ an overview of the buttonholes and eyelets appears in the display
- ▶ select the desired buttonhole



51 Standard Buttonhole
For light- to medium weight fabrics: blouses, dresses, bed linen, etc.



61 Eyelet with Small Zigzag
Opening for cords and narrow ribbons/bands and decorative work



52 Narrow Buttonhole
For light- to medium weight fabrics: blouses, dresses, children's and baby clothes, crafts

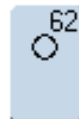

62 Straight Stitch Eyelet
Opening for cords and narrow ribbons/bands and decorative work



54 Round Buttonhole with Normal Bartack
For medium- to heavy weight fabrics of all types: dresses, jackets, coats, rainwear



56 Keyhole Buttonhole with Normal Bartack
For heavy weight, non-stretch fabrics: jackets, coats, leisure wear

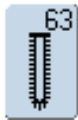

63 Heirloom Buttonhole
For light- to medium weight woven fabrics: blouses, dresses, leisure wear, bed linen

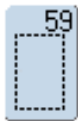

59 Straight Stitch Buttonhole
Program for staystitching buttonholes, for pocket openings, reinforcing buttonholes; especially for buttonholes in leather and imitation leather



60 Button Sew-on Program
Sewing on buttons with 2 and 4 holes

Combining with Functions

Manual 5- or 7-Step Buttonhole

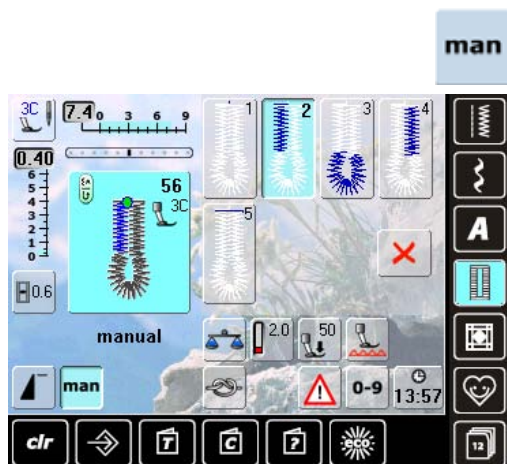

▶ attach foot no. 3C

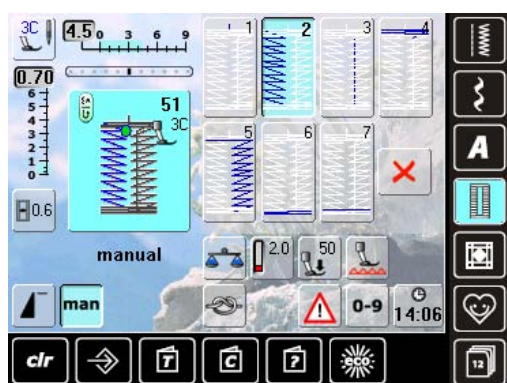

- ▶ select desired buttonhole type
- ▶ touch the «man» icon = manual

Sewing 5-Step Buttonhole

- ▶ the length of the beads is determined manually while sewing
- ▶ bartack, eye and securing stitches are pre-programmed
- ▶ individual steps can also be selected by pressing the Quick Reverse button
- ▶ step «1» is activated for the beginning of the buttonhole
- ▶ at the beginning of sewing, step «2» is activated
- ▶ sew first bead
- ▶ stop sewing at the desired bead length
- ▶ touch «3»
- ▶ sewing computer sews the eye or the keyhole
- ▶ touch «4»
- ▶ sewing computer sews 2nd bead in reverse
- ▶ stop sewing at the first stitch
- ▶ touch «5»
- ▶ sewing computer sews the top bartack and secures stitches automatically

Sewing 7-Step Buttonhole

- ▶ step «1» is activated for the beginning of the buttonhole
- ▶ at the beginning of sewing, step «2» is activated
- ▶ sew first bead
- ▶ stop sewing at the desired bead length
- ▶ touch «3»
- ▶ sewing computer sews straight stitches in reverse
- ▶ stop sewing computer at the 1st stitch of the first bead
- ▶ touch «4»
- ▶ the sewing computer sews top bartack and stops automatically
- ▶ touch «5»
- ▶ sewing computer sews the second bead
- ▶ stop sewing
- ▶ touch «6»
- ▶ the sewing computer sews bottom bartack and stops automatically
- ▶ touch «7»
- ▶ sewing computer secures stitches and stops automatically



Leave Program

- ▶ touch **X** or «man»
- ▶ screen reverts to original Buttonhole screen



Buttonhole Slit Width

- ▶ select buttonhole
- ▶ touch «Buttonhole Slit Width» icon
- ▶ set the cutting space width using the stitch width or stitch length knobs (0.1 - 2mm)
- ▶ larger slit width will result in narrower beads



Buttonhole Stitch Counter

- ▶ select buttonhole
- ▶ touch the «Stitch Counter» icon
- ▶ when the desired length is achieved (first bead) press the Quick Reverse button
- ▶ after the length of the second bead has manually been set using the Quick Reverse button, the display changes to «auto»
- ▶ the selected buttonhole is programmed
- ▶ for making very large repeatable buttonholes



Programming Buttonhole Length

- ▶ the icon is automatically highlighted in blue (= active) when a buttonhole is selected
- ▶ buttonhole length can be set with the Quick Reverse button or the length can be programmed directly by touching the icon
- ▶ if the buttonhole is programmed the icon is inactive, gray
- ▶ if a new length is to be programmed, touch the icon again



Balance for Direct Entry Length Standard Buttonhole

- ▶ balance alterations have the same effect on both beads



A

Balance for Manual Keyhole or Round Buttonhole

Balance alterations affect the two beads differently:

If left bead too dense (picture A):

- ▶ turn the stitch length knob counterclockwise = left bead will be longer, right bead gets shorter

If left bead not dense enough (picture B):

- ▶ turn stitch length knob clockwise = left bead will be shorter, right bead will be longer

▶ the keyhole or eye is balanced as follows:

If keyhole is distorted to the right (picture C):

- ▶ turn the stitch length knob clockwise

If keyhole is distorted to the left (picture D):

- ▶ turn the stitch length knob counterclockwise



B

Balance for Manual Standard Buttonhole

- ▶ balance alterations have the same effect on both beads

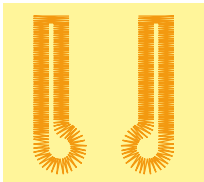

C

D

Balance for Direct Entry Length Keyhole or Round Buttonhole

- ▶ balance alterations have the same effect on both beads
- ▶ the keyhole or eye is balanced as follows:
- ▶ straight stitch until the sewing computer changes to the keyhole or eye, then stop sewing
- ▶ touch the «Balance» icon and adjust the picture in the right portion of the Balance screen with the stitch length knob to match the sewn buttonhole

If keyhole is distorted to the right (picture C):

- ▶ turn stitch length knob counterclockwise

If keyhole is distorted to the left (picture D):

- ▶ turn stitch length knob clockwise
- ▶ touch ✓ and complete buttonhole

Balance for Stitch Counter Buttonhole

- ▶ balance alterations have a different effect on both beads (see picture for manual buttonhole)
- ▶ re-program the buttonhole after each alteration in balance

Clear Balance

- ▶ touch the «Reset» icon in the special Balance screen or press the «clr» button («clr» also deletes the programmed buttonhole!)

Recommendation

- ▶ sew a test buttonhole on a piece of the original fabric



In all Direct Entry length and manual buttonholes each individual buttonhole sequence can be balanced separately. In stitch counter buttonholes the balance affects both beads differently (left and right): when altering the bead the keyhole or eye are automatically altered accordingly.

Automatic

Direct Entry Length



Entering Buttonhole Length or Button Measuring

Buttonholes can be sewn to a specific length with the Automatic Buttonhole Foot with Slide No. 3A. Buttonhole length = cutting length in mm

- ▶ select type of buttonhole
- ▶ touch the «Direct Entry Length» function

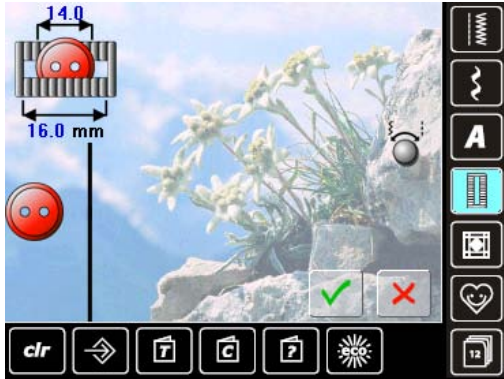

Determining Buttonhole Length

- ▶ enter the buttonhole length using the multifunction knobs (stitch width or stitch length knob)
- ▶ the length entered appears below the buttonhole
- ▶ the number above the button is the exact button size
- ▶ confirm the desired length with ; the screen changes automatically
- ▶ «auto» and the programmed length in mm appear on the screen

Back to Buttonhole Menu

- ▶ touch to return to the buttonhole menu; the original settings remain

Button Measurement

Determining Button Size

- ▶ the sewing computer calculates the length of the buttonhole directly from the diameter of the button
- ▶ 2mm are automatically entered for the button thickness
- ▶ hold the button against the left side of the screen
- ▶ using the multifunction knobs, place the vertical black line flush on the right side of the button
- ▶ the button size in mm is visible above the button, between two arrows (e.g. 14mm)
- ▶ remove the button from the screen
- ▶ confirm the correct size with the icon, the screen automatically changes

Corrections for Thick Buttons

- ▶ match buttonhole length to buttonhole thickness (raised buttons, etc.) e.g. buttonhole length + 1cm (incl. 2mm) if button height is 1cm
- ▶ allow the button to pass through the buttonhole easily



Important in the event of an Error in Manipulation

- ▶ touch the «Pattern begin» icon
- ▶ the sewing computer sets the program to the start of the buttonhole again



Deleting Saved Buttonholes

- ▶ press the «clr» button or touch «recording»
- ▶ «auto» disappears and «recording» appears
- ▶ a new buttonhole length can be programmed

Programming

Automatic Buttonhole



- ▶ the length of the buttonhole is automatically measured with the buttonhole foot with slide no. 3A. The sewing computer automatically switches to the next sewing stage after reaching the maximum length
- ▶ for buttonholes of 4-31 mm, depending on the buttonhole type



Both beads are sewn in the same direction.

Standard and Stretch Buttonhole

No. 51, 52

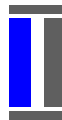

Sewing First Bead

- ▶ the stitching sequence is displayed in the Stitch Altering Area
- ▶ sew the first bead forwards and stop at the required length



Programming the Buttonhole

- ▶ press the Quick Reverse button, continue sewing
- ▶ «auto» and the programmed length (in mm) appears in the display = buttonhole length is programmed



Auto Buttonhole

The sewing computer sews automatically:

- ▶ straight stitches in reverse
- ▶ first bartack
- ▶ 2nd bead forwards
- ▶ 2nd bartack
- ▶ secures stitches, stops and automatically goes to the beginning of the buttonhole

All additional buttonholes are now automatically sewn in the same length in one step.

Round and keyhole buttonholes

No. 54, 56



Sewing Straight Stitches

- ▶ sew straight stitches forwards, stop at required length

Programming the Buttonhole

- ▶ programming is done as for the other buttonholes



Auto Buttonhole

The sewing computer sews automatically:

- ▶ round or eye part of buttonhole
- ▶ first bead in reverse
- ▶ straight stitch forwards
- ▶ second bead in reverse
- ▶ bartack
- ▶ secures stitches, stops and automatically goes to the beginning of the buttonhole

Hand-look buttonhole

No. 63

Sewing the first bead

- ▶ sew first bead forwards, stop at required length

Programming the Buttonhole

- ▶ programming is done as for the other buttonholes

Auto Buttonhole

The sewing computer sews automatically:

- ▶ round part of buttonhole
- ▶ second bead in reverse
- ▶ bartack and securing stitches, stops and automatically goes to the beginning of the buttonhole

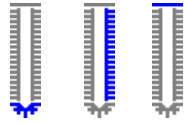

Double sewn keyhole buttonholes

- ▶ keyhole buttonholes can be sewn twice on thick fabrics – the first lap is stitched with a longer stitch length than the second
- ▶ do not move the fabric after sewing the first buttonhole; just tap the foot control once to sew buttonhole again

Stitch Counter Buttonhole



- ▶ attach foot no. 3C

All Buttonhole Types

Sewing the first bead

- ▶ sew first bead forwards, stop at required length

- ▶ press the Quick Reverse button on head frame

Bartack, Second Bead in Reverse

- ▶ bottom bartack and second bead are sewn in reverse
- ▶ stop sewing computer at the first stitch
- ▶ press Quick Reverse button on head frame

Bartack, Securing Stitches

- ▶ the sewing computer sews the top bartack, secures stitches and stops automatically
- ▶ «auto 1,2,3» appear on the screen
- ▶ the buttonhole is saved

Each subsequent buttonhole will be sewn identically.



- ▶ the first bead (left) is sewn forwards, the second bead (right) is sewn in reverse
- ▶ the stitch counter buttonhole cannot be saved in the long term Memory

In Long-Term Memory

Long-term saving of buttonhole programs is only possible for buttonholes originally stitched as «auto» length buttonholes.



Saving Buttonhole

- ▶ touch the displayed buttonhole in the Stitch Altering Area
- ▶ touch the «Save» function – the buttonhole is saved in the Long Term Memory

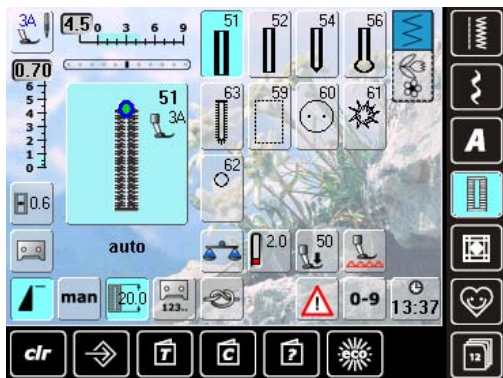

Recalling Saved Buttonhole

- ▶ select the desired buttonhole type
- ▶ the length of the buttonhole appears in the «Direct Entry Length» icon
- ▶ «auto» and the length in mm appear on the screen

Changing Saved Buttonhole

- ▶ select the desired buttonhole type
- ▶ touch the «Direct Entry Length» icon
- ▶ alter the length of the saved buttonhole; confirm with ✓
- ▶ save buttonhole as described above
- ▶ the new buttonhole length overrides the existing one

Deleting Saved Buttonhole

- ▶ select desired buttonhole type
- ▶ touch the «Direct Entry Length» icon and program a new length or touch the buttonhole displayed in the Stitch Altering Area
- ▶ touch «Reset» = the saved buttonhole is deleted
- ▶ a new buttonhole length can be programmed

Button Sew-On Program

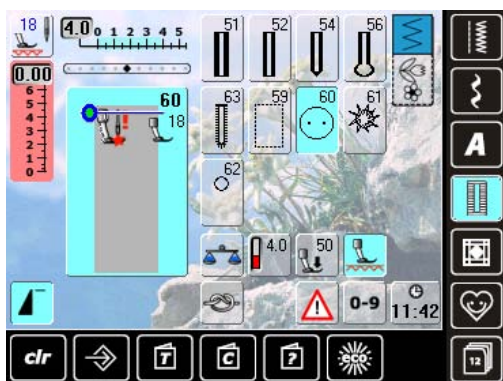

Sewing on a 2-Hole Button

- ▶ check the distance between the holes by turning the handwheel and adjust the stitch width if necessary
- ▶ hold the threads when starting to sew
- ▶ sew on the button
- ▶ the sewing computer automatically stops when program is completed and is immediately ready for the next button



If the stitch width is reduced too sharply (gray area), the sewing computer cannot be started. An animation appears.



▶ attach foot no. 18

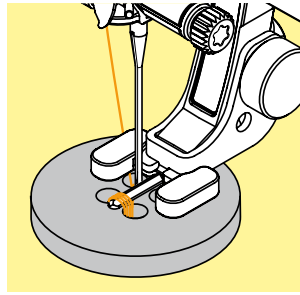

Sewing on a 4-Hole Button

- ▶ sew the front holes first
- ▶ carefully move the button forward
- ▶ sew the back holes with the same program

Start and End Threads

- ▶ the threads have already been secured and can be trimmed



For Secure Results

- ▶ pull both lower threads until the ends of the upper threads are visible on the wrong side (knot if required)
- ▶ trim threads



Sewing on Buttons

A real time-saver for projects where several buttons of the same type must be sewn on (e.g. blouse, bed linen etc.). For work which is subject to heavy wear or washing, sew buttons on using button sew-on program twice.



2- and 4-hole-buttons can be attached. The thread shank (distance between the button and the fabric) can be set as required using foot no 18. Buttons for decorative purposes are just sewn on, without the thread shank.

Eyelet Program

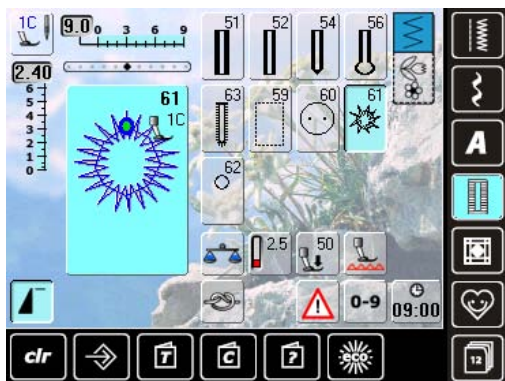

- ▶ select desired eyelet:
- ▶ no. 61 = zigzag eyelet
- ▶ no. 62 = straight stitch eyelet

Sewing Eyelets

- ▶ position fabric under the presser foot and sew
- ▶ the sewing computer stops automatically when finished and is immediately ready for the next eyelet



Punching Eyelets

- ▶ use an awl or punch to cut open the eyelet

Quilt Stitches Description

Various stitch patterns are available which are used especially in quilting, for patchwork or for appliqué:

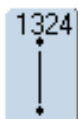

1324 Quilters securing program



1333 Feather Stitch Variations
1333 - 1338

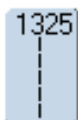

1325 Quilting straight stitch

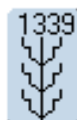

1339 Decorative quilt stitches
1339 - 1345, 1351

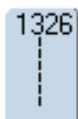

1326 Piecing stitch/Straight stitch

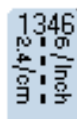

1346 Quilt stitch/Handlook quilt stitch variations
1346 - 1350



1327 Stippling stitch

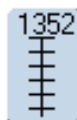

1352 Blanket stitch (dual)

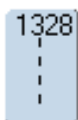

1328 Handlook quilt stitch



1353 Double blanket stitch (dual)

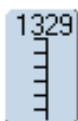

1329 Blanket stitch



1354 Satin stitch



1330 Double blanket stitch



1331 Blind stitch

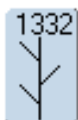

1332 Feather stitch

Creating a Customized Stitch Menu

Use the Personal Program to create a file with stitches you use most for a special project.



Personal Screen

- ▶ the programmed stitch patterns are shown with pattern numbers
- ▶ when more than 12 stitches are programmed, use arrow to scroll for viewing additional stitches
- ▶ the programmed stitch patterns in this screen can be altered in the usual way



The following alterations can be saved:

- ▶ Stitch width
- ▶ Stitch length
- ▶ Needle position
- ▶ Thread tension
- ▶ Mirror Image
- ▶ Pattern extend
- ▶ Long stitch
- ▶ Balance
- ▶ Pattern repeat 1–9x

If the memory has already been filled with stitch pattern combinations, no further stitch patterns can be saved in the Personal Program. The content in the memory must first be deleted to ensure there is sufficient free space.

Preparing Stitch Patterns

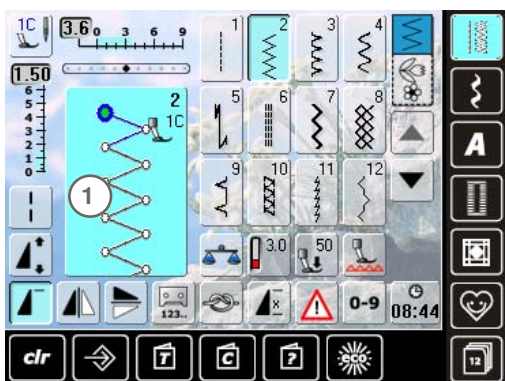

Programming of first Stitch Pattern

- ▶ select in the practical stitch screen, e.g. zigzag stitch
- ▶ make alterations
- ▶ touch the Stitch Altering Area 1 (light blue)



- ▶ the following screen appears
- ▶ touch the «Add» icon 2



- ▶ a screen with two files appears
- ▶ select the file where the stitch pattern is to be saved, e.g. 1
- ▶ each file can accommodate 100 stitch patterns in maximum



- ▶ touch the flashing «Save» icon 3
- ▶ the altered zigzag stitch is saved and the screen closes
- ▶ the file can be named by pressing the large gray icon 4 and the name can be typed in using the keyboard provided
- ▶ touch the «Return» icon to return to file overview

Altering Stitch Patterns

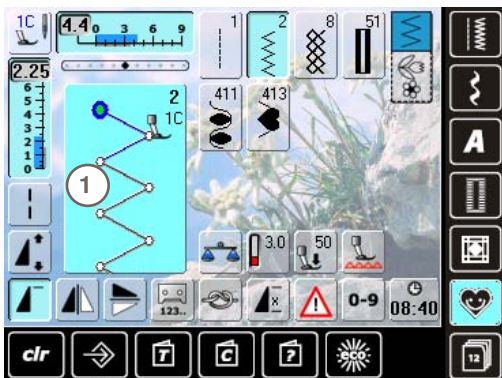

Selecting Stitch Pattern

- ▶ alter stitch width and stitch length using the knobs
- ▶ the alterations and the basic settings are visible
- ▶ touch the Stitch Altering Area (light blue) 1



- ▶ touch the «Save Settings» bar 2
- ▶ all alterations are saved; the special screen closes

Deleting Stitch Patterns

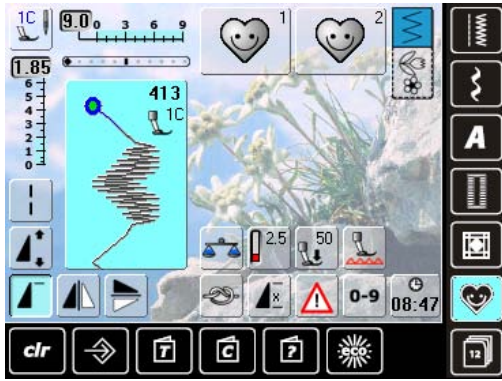

Selecting Stitch Pattern

- ▶ touch the «Personal Program» icon
- ▶ the screen appears with the two files
- ▶ select the file where the stitch pattern is to be deleted, e.g. 1
- ▶ touch the Stitch Altering Area (light blue)
- ▶ touch the «Add» icon (as for programming)



- ▶ the content of the file selected is shown
- ▶ select the stitch pattern to be deleted
- ▶ the stitch pattern is deleted; all the remaining patterns are moved by one position
- ▶ close the screen with **X**

Special Screen

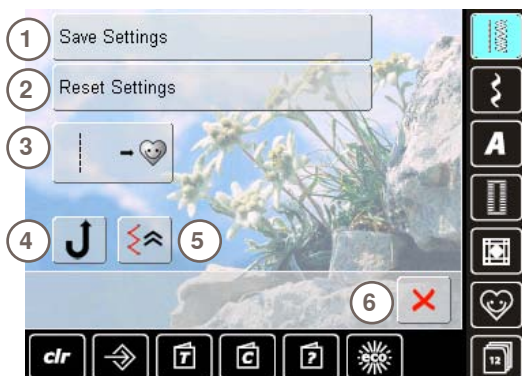

- 1 All alterations (stitch lengths, stitch widths, etc.) of the stitch pattern selected are saved
- 2 All alterations of the stitch pattern selected are reset to the original basic setting
- 3 Add a selected stitch pattern to your Personal Program (with possible alterations)
- 4 The sewing computer sews continuously in reverse
- 5 The stitch pattern is sewn in reverse, retracing the previously sewn stitches by the stitch
- 6 Close the screen

History Description



- ▶ touch the «History» icon
- ▶ the last maximum 12 sewn stitches appear
- ▶ a stitch already contained in the History screen will be overwritten when sewing restarts

Long Term Memory Description

In the memory stitch patterns, lettering and numbers can be combined and saved.

In the memory each «Drawer» can store a maximum of 70 stitch patterns as long as there is sufficient free space (capacity) available.

The memory is long-term, i.e. contents are kept until they are deleted. A power cut or switching off the sewing computer does not have any effect on the stored contents.

Creating Stitch Combinations

Programming and Saving

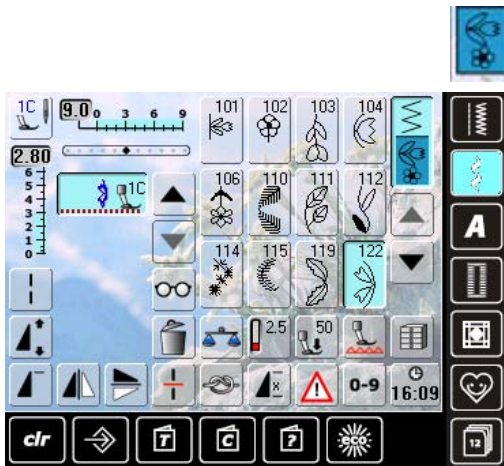

- ▶ select «Combi Mode»
- ▶ the Stitch Altering Area and the respective function fields appear
- ▶ select the desired stitch pattern directly or type in the number
- ▶ make any necessary changes such as stitch length, stitch width, needle position and add functions such as mirroring, etc.
- ▶ select further stitch patterns



- ▶ touch the flashing «File Drawers» icon
- ▶ the «Save» icon is activated
- ▶ the System Memory Capacity is shown in percent (%) in a bar in the top right

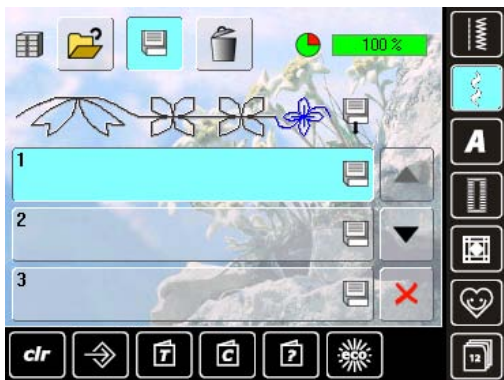

- ▶ select the Drawer where you wish to save the stitch combination

Deleting Stitch Patterns



Deleting patterns in steps

- ▶ the stitch pattern above the cursor is deleted
- ▶ touch «Delete» as many times as required until the Stitch Altering Area is empty



Deleting a Combination

- ▶ touch the «Multifunction» icon
- ▶ touch «Delete»
- ▶ confirm with ✓



Opening Empty File Drawers

- ▶ touch the «File Drawers» icon
- ▶ Drawers screen appears
- ▶ touch «Open» in the top row
- ▶ select an empty Drawer



Drawer Content at a Glance



- ▶ touch the «Multifunction» icon
- ▶ in the screen the following is displayed:
 - 1 the complete stitch combination
 - 2 the entire length of the stitch combination can be viewed
 - 3 turning Multifunction knobs
 - 4 Mirror Combination
 - 5 Combination Sub-Divider
 - 6 Delete Combination
 - 7 Backstepping
 - 8 **X** icon
- ▶ scroll through the combination with the arrow icons
- ▶ each stitch pattern can be directly selected e.g. for alterations
- ▶ select stitch pattern and make the alterations directly in the Stitch Altering Area
- ▶ close the screen with **X**

Opening a Saved Stitch Combination



- ▶ touch the «File Drawers» icon
- ▶ a summary of the saved combinations appears
- ▶ scroll to the desired Drawer if necessary
- ▶ touch the desired Drawer
- ▶ the saved combination appears in the Stitch Altering Area

Correcting a Stitch Combination



Inserting Stitch Patterns

- ▶ select the desired position in the combination
- ▶ select a new stitch pattern
- ▶ the new stitch pattern will be added after the selected stitch pattern

- ▶ to add a pattern at the beginning of a combination, the cursor must be positioned above the first pattern

Altering a Stitch Combination

- ▶ select desired stitch in the combination
- ▶ select desired function e.g. Mirroring



The alterations always affect the Stitch above the cursor that is active or light blue.

Saved stitch combinations can be altered or corrected in the same way. To make corrections and alterations permanent, the combination must be saved again afterwards.



Mirroring Entire Combinations

- ▶ touch the «Multifunction» icon
- ▶ the screen changes
- ▶ touch the «Mirror image» icon



Combination Subdivider 1

- ▶ a combination can be subdivided into several sections with the «Subdivider 1» function
- ▶ only the section where the cursor is positioned is sewn
- ▶ to sew the next section, the cursor must be placed in the respective section



Combination Subdivider 2

- ▶ touch the «Multifunction» icon
- ▶ a combination can be split into various sections using the «Combination Subdivider 2» function
- ▶ sew the first section, the sewing computer stops automatically when it reaches the programmed function
- ▶ reposition the fabric, press the foot control = the next section is sewn etc.

Deleting a Stitch Combination



Overwriting

- ▶ program a new stitch combination
- ▶ touch the «File Drawers» icon
- ▶ select the Drawer which you want to overwrite
- ▶ confirm with ✓



Deleting

- ▶ touch the «File Drawers» icon
- ▶ a summary of the saved combinations appears
- ▶ touch the «Delete» icon
- ▶ select the Drawers to be deleted
- ▶ confirm with ✓; deleting will be stopped by touching ✗
- ▶ touch the ✗ icon – File Drawers summary closes

BERNINA Sewing World

Practical Applications	88	Decorative Applications	103
Practical Stitches	88	Cross Stitches	103
Straight Stitch no. 1	88	Bobbin-Play Sewing	104
Basting Stitch no. 21	88	Free Motion Sewing	104
Triple Straight Stitch no. 6	89	Decorative Stitches	104
Securing Stitch no. 5	89	Tapering	105
Patchwork, Appliqué, Quilting	90	Sewing Pin Tucks	106
Optimal Stitch Patterns	91	Quilt Techniques	107
Edge Finishing	92	Quilt Labels	107
Narrow Edgestitching	92	Free Motion Quilting	107
Wide Edgestitching	92	BSR	108
Overcasting	93	BSR Description	108
Darning	94	Preparation	109
Manual - Straight Stitch no. 1	94	Functions in the BSR mode	110
Automatic - Simple Darning Program no. 22	95	Needle Stop Down (Default)/Up	110
Reinforced Darning Program no. 34	95	Raise or Lower the Needle	110
Knits Neatening	96	Securing With the Start/Stop Button (only Mode 1)	110
With Double Overlock no. 10	96	Securing Function (only Mode 2)	110
Hem	96	Free Motion Quilting (only Mode 2)	110
Visible	96	Free Motion Quilting without BSR activation	110
Jersey Stitch no. 14	96	Beeper (Acoustic Signal) Deactivation/	
Blind	97	Activation	111
Flat Joining Seam	97	Activating the BSR Sewing Function:	112
Stretch Overlock no. 13	97	Deactivating the BSR Sewing Function	
Zippers	98	by using the Start/Stop Button	112
Inserting	98	Holding the Work	112
With Straight Stitch no. 1	98	BSR Function Deactivation	112
Buttonhole	99	BERNINA Dual Feed	113
Important Information	99	BERNINA Dual Feed Description	113
Preparation	99	Fabrics	114
Thread Tension	99	Application	114
Test Sewing	99		
Corrections	99		
Manual Buttonholes	99		
Automatic Buttonholes	99		
Stabilizers and Interfacings	100		
Corded Buttonholes	100		
Keyhole Buttonholes	100		
Automatic Buttonholes	100		
Corded Buttonholes With Presser Foot no. 3C			
(optional accessory)	101		
Corded Buttonholes With Buttonhole Foot no. 3A	101		
Cutting Open the Buttonhole	102		
Securing the Cord	102		

Practical Stitches

Straight Stitch no. 1

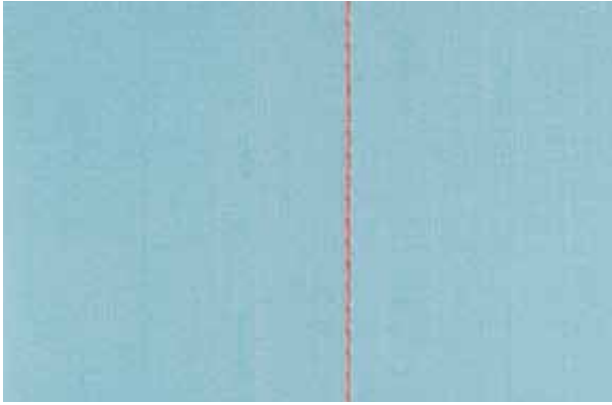

Straight Stitch

- ▶ after turning the sewing computer on, the Practical Stitch screen with the activated straight stitch appears
- ▶ for specialty work, program the seam length using the stitch counter function, see page 34

Application

- ▶ suitable presser foot to be selected according to the technique, e.g. manual darning
- ▶ suitable for all fabrics



Adjust the stitch length to suit the fabric

For example, use a longer stitch length (approximately 3 - 4mm) with denim, a shorter length (2 - 2.5mm) with batiste.

Adjust the stitch length to suit the thread

For example, use a longer stitch length (approximately 3 - 5mm) when using cordonnet thread for topstitching.

Activate Needle Stop Down

Prevents the fabric from slipping when you stop to adjust or pivot project.



- ▶ Reverse pattern foot no. 1C/1D

Basting Stitch no. 21

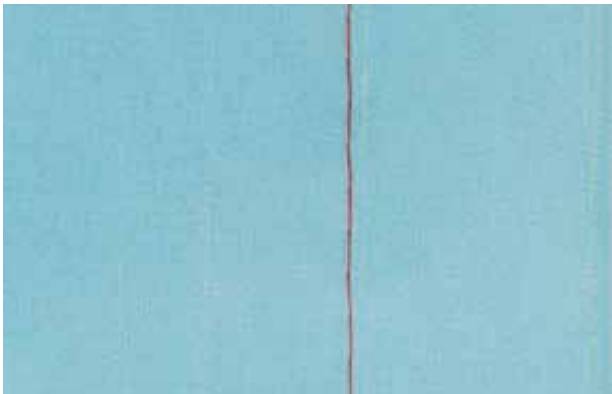

Basting Stitch

- ▶ straight stitch, sews out every fourth stitch, i.e. longest stitch possible is 24mm when the stitch length is set at 6mm. Recommended stitch length is 3.5 - 6mm
- ▶ for all work where a very long stitch is required
- ▶ quick and easy basting of seams, hems, quilts, etc.
- ▶ easy to remove

Preparation

- ▶ pin work horizontally to basting direction to prevent the layers slipping



Securing/fixing the thread

- ▶ sew a few basting stitches at the beginning and end of a seam

Basting

- ▶ use a fine darning thread for basting as it is easier to remove

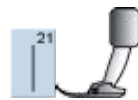

- ▶ Reverse pattern foot no. 1C/1D

Triple Straight Stitch no. 6



Open Seam

- ▶ durable seam for firm and densely woven fabrics such as denim and corduroy
- ▶ reinforced seam subjected to hard wear
- ▶ durable seam for high stress areas such as children's clothing



- ▶ Reverse pattern foot no. 1C
- ▶ Jeans foot no. 8



For heavy layers or very densely woven fabrics:

A Jeans needle and Jeans foot no. 8 will help when sewing very heavy fabrics such as denim or canvas.

Decorative top stitch

Lengthen stitch and use as a decorative top stitch with denim.

Securing Stitch no. 5

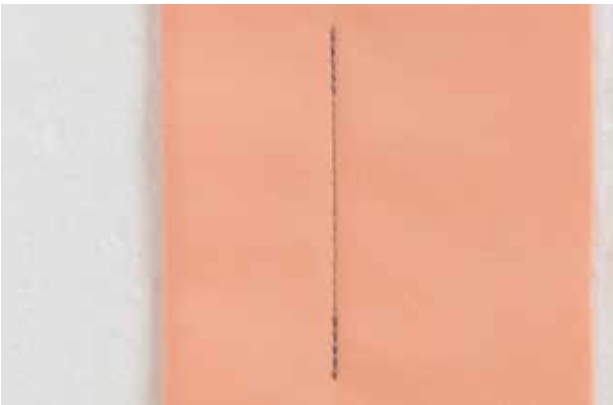

Straight Stitch With Securing

- ▶ for all fabrics
- ▶ secures beginning and end of seam

Beginning the Seam

- ▶ the sewing computer secures the seam automatically (5 stitches forward, 5 stitches reverse)
- ▶ the sewing computer continues straight stitching forwards

Ending the Seam

- ▶ when coming to the end of the seam, press and release the Quick Reverse button on head frame. The sewing computer will then secure the seam automatically (5 stitches reverse, 5 stitches forward)
- ▶ sewing computer stops automatically when securing is completed



Seaming or sewing long seams

- ▶ quicker securing at beginning and end of seam
- ▶ even securing by defined stitch count



- ▶ Reverse pattern foot no. 1C

Patchwork, Appliqué, Quilting



Accuracy is essential when sewing patches together. The side edges of the Patchwork foot are exactly 1/4" (6mm) from the center needle position. The center indents on either side of the foot indicate the needle insertion point and the two additional indents are 1/4" (6mm) in front of and behind the needle. When sewing at a foot's width, the seam allowances will always be the exact width and it is easy to turn the work while maintaining the same width.



- ▶ Patchwork foot no. 37/37D
- ▶ Patchwork foot no. 57/57D (optional accessory)
- ▶ Reverse pattern foot no. 1C

Optimal Stitch Patterns

for patchwork no. 37D/57D

- ▶ no. 1 Straight stitch (stitch length 1.5 - 2mm)
- ▶ no. 1326 Straight stitch

It is not necessary to secure the stitches for these relatively short seam lengths. Attach the slide-on table for precise and easier work.

for appliqué no. 1C/20C

- ▶ no. 1354 Satin stitch
- ▶ no. 1329, 1330, 1352, 1353 Blanket stitch
- ▶ no. 1331 Blind stitch

for quilting no. 1C

- ▶ no. 1324 Quilters securing program
- ▶ no. 1325 Quilting/straight stitch
- ▶ no. 1328, 1346 – 1350 Quilt stitch/hand-look quilt stitch
- ▶ no. 1327, 1331 – 1345, 1351 Decorative quilt stitch
- ▶ Free Motion quilting with or without BSR

Edge Finishing

Narrow Edgestitching

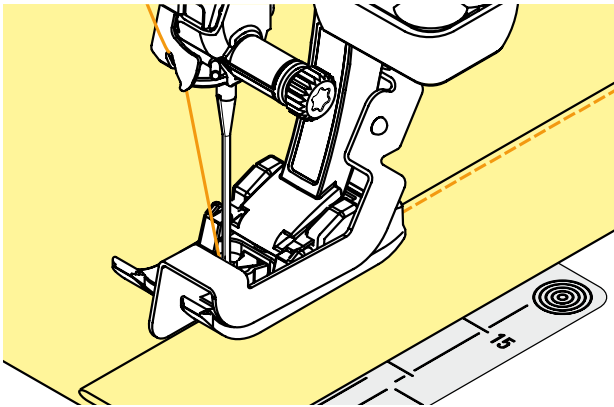
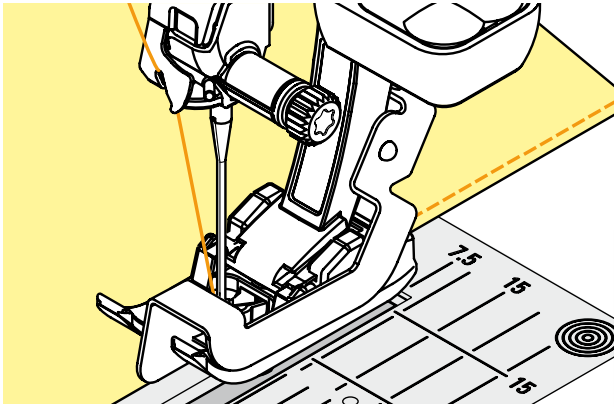

Outer Edges

- ▶ place edge of fold against the guide on the Blindstitch foot
- ▶ select needle position at desired distance from the folded edge



- ▶ foot no. 5:
use any left or far right needle position
- ▶ foot no. 1C and no. 10/10C/10D:
any needle position is possible

Hem Edges

- ▶ place edge of fold against the guide on the Blindstitch foot (inside upper edge of hem)
- ▶ select needle position to the right to sew along the upper edge



- ▶ Reverse pattern foot no. 1C
- ▶ Blindstitch foot no. 5
- ▶ Edge stitch foot no. 10/10C/10D (optional accessory)

Wide Edgestitching

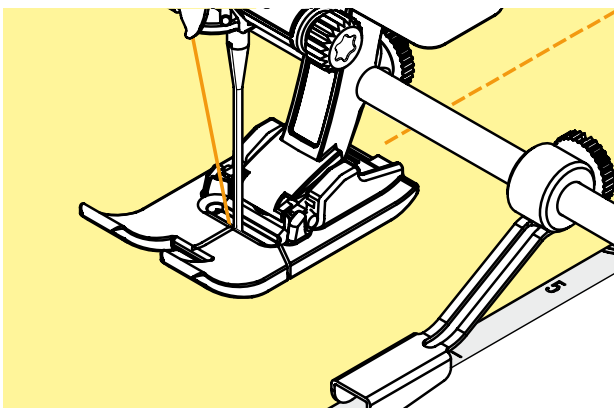
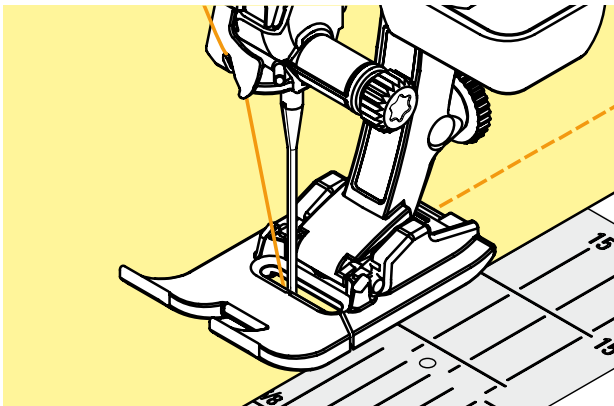

There are three options for wide edge stitching

- ▶ guide the folded edge along the edge of the presser foot
- ▶ guide the folded edge along the marks on the stitch plate (for stitching 3/8" to 1" from the edge (1 to 2.5cm))

- ▶ insert the adjustable seam guide into the hole on the back of the presser foot shaft
- ▶ adjust as desired
- ▶ tighten the screw
- ▶ guide the folded edge along the seam guide
- ▶ to sew parallel wider lines, guide the seam guide along a previously sewn line of stitches

Overcasting



With Zigzag Stitch no. 2

- ▶ guide edge of fabric into the center of the presser foot
- ▶ do not select too wide a width or too long a stitch – the edge should lie flat and not roll
- ▶ needle goes into fabric on one side and over the edge into the air on the other side
- ▶ use a fine darning thread for lightweight fabric



Satin Stitch

- ▶ dense stitch used for appliqué, embroidery, etc.
- ▶ shorten stitch length, satin stitch setting will be indicated by parallel lines on stitch length bar

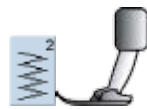

- ▶ Reverse pattern foot no. 1C

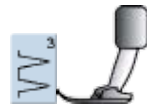

If edges roll:

- ▶ use the Vari-overlock stitch and foot no. 2A (optional accessory)



The sewing computer has a programmed satin stitch: no. 1354

Darning

Manual - Straight Stitch no. 1

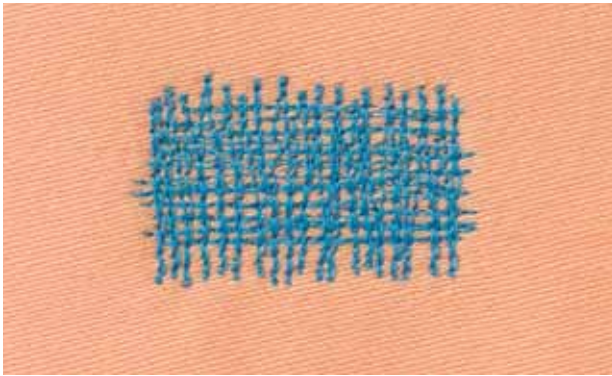

Darning Holes or Worn Areas

Preparation

- ▶ lower the feed-dog
- ▶ attach the Slide-on table
- ▶ hoop the fabric into the darning hoop (optional accessory). The darning area stays evenly taut and cannot be distorted

Sewing

- ▶ work from left to right without using pressure
- ▶ when changing direction on top and on bottom, move in curves (avoid points as this prevents holes and thread breakage)
- ▶ work in different lengths so that the thread is better spread over the fabric



▶ Darning foot no. 9

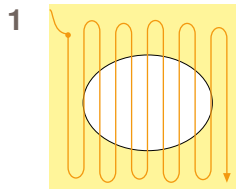

1

Stitch Over the Hole 1

- ▶ sew the first rows to cover the hole (not too close, sewing beyond the worn area)
- ▶ work the rows in irregular lengths
- ▶ turn work by a quarter turn - 90°

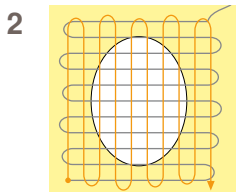

2

Cover the First Rows 2

- ▶ sew over the first rows - not too close for a soft finish
- ▶ turn work by a half turn - 180°

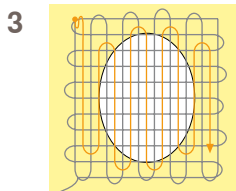

3

Complete Darning 3

- ▶ sew loosely and in same direction as 2nd rows



Poor stitch formation

- ▶ if the thread is lying on the right side of the fabric, the hoop is being moved too quickly
- ▶ if there are knots on the wrong side of the fabric, the hoop is being moved too slowly

Thread breaks

If thread breakage is a problem, it could be that the hoop is not being moved smoothly.

Automatic - Simple Darning Program no. 22

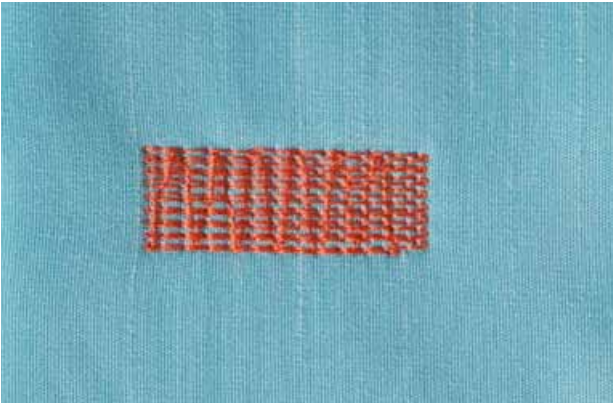

Replaces threads along the lengthwise grain in all fabrics.

Preparation

- ▶ place a piece of lightweight stabilizer under the worn area before darning if necessary

Sewing

- ▶ sew the first row and stop
- ▶ press and release the Quick Reverse button at the desired length; this programs the first length
- ▶ continue sewing; the sewing computer stops automatically

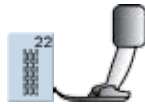

- ▶ Reverse pattern foot no. 1C
- ▶ Automatic buttonhole foot no. 3A



If the darning becomes distorted
Correct with the Balance function see page 51.



If the darning does not cover the whole worn or damaged area.
Reposition the work under the foot to continue covering the worn or damaged area. Begin sewing; the program will repeat as often as desired (the length is saved).

Reinforced Darning Program no. 34

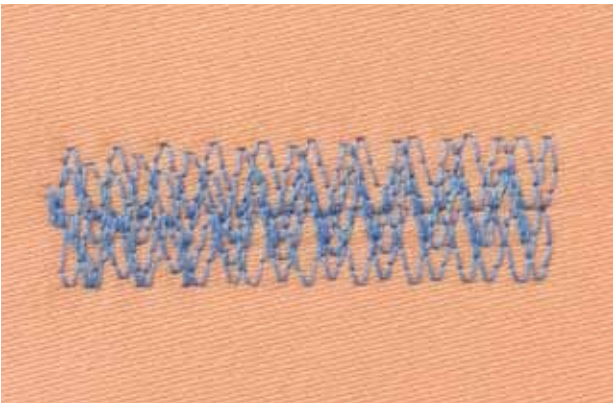

The Darning Program no. 34 is particularly useful for mending heavy weight or durable garments, such as jeans and overalls.

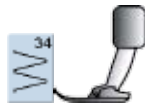

- ▶ Reverse pattern foot no. 1C

Knits Neatening

With Double Overlock no. 10



Closed Seam

- ▶ overlock seam in loose knits and cross seams in knits and jerseys

Sewing

- ▶ sew the overlock seam along the raw edge

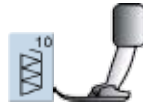

- ▶ Reverse pattern foot no. 1C
- ▶ Overlock foot no. 2A (optional accessory)



Knits and jersey

- ▶ use a new ball point needle to prevent damaging the loops



Sewing stretch fabrics

- ▶ if necessary use a stretch needle (130/705H-S) = needle point slides between the fibers

Hem

Visible



Jersey Stitch no. 14

Stretch Hem

- ▶ for all types of cotton, wool, synthetic and mixed fiber jerseys

Preparation

- ▶ fold hem, pin if necessary

Sewing

- ▶ sew hem at preferred depth on the right side of fabric
- ▶ trim excess fabric (wrong side)

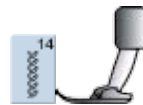

- ▶ Reverse pattern foot no. 1C/1D

Blind

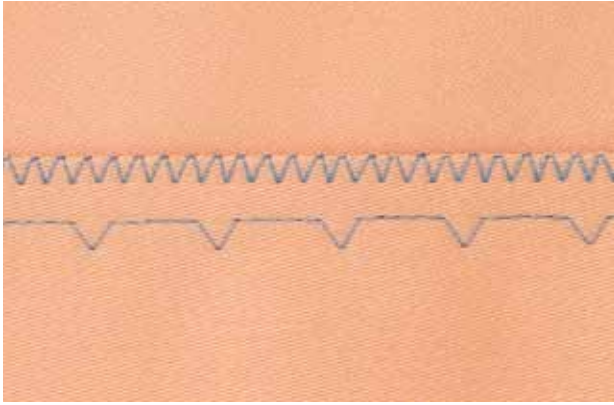

wide

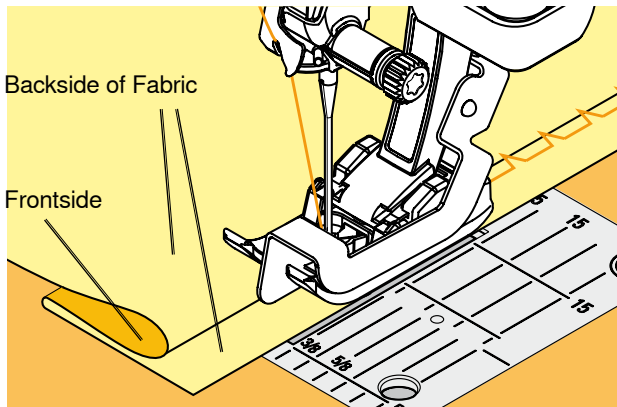

Blindstitch Wide no. 9

- ▶ for medium weight to heavy fabric

Preparation

- ▶ finish the raw edges as desired
- ▶ fold the hem and baste or pin in place
- ▶ fold the garment back over the right side of the fabric to expose the finished lower edge (see drawing)
- ▶ place the work under the presser foot with the guide positioned against the folded back fabric

Sewing

- ▶ the needle should just pierce the edge of the fold
- ▶ after sewing about 4" (10cm), check both sides of fabric and adjust the stitch width if necessary



▶ Blindstitch foot no. 5

Flat Joining Seam

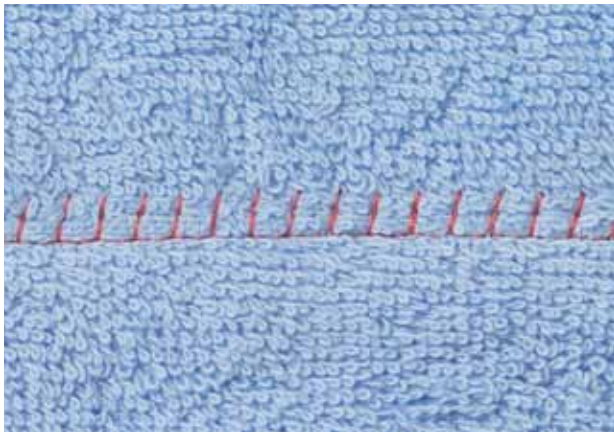

Stretch Overlock no. 13

- ▶ ideal for fluffy, thick materials such as terry cloth, felt and leather

Sewing

- ▶ fabric edges are overlapped and the stitch is placed on the seam allowance which produces a very flat, durable seam
- ▶ sew stretch overlock along the fabric edge
- ▶ the stitch should sew over the edge of the top layer of fabric on the right swing of the needle



▶ Reverse pattern foot no. 1C

Zippers

Inserting

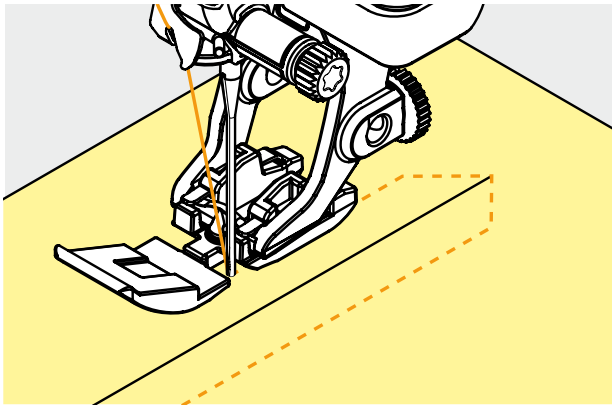

Preparation

- ▶ select the icon showing the attached presser foot in the presser foot selection (refer to p. 56)
- ▶ baste seam closed and clean finish the seam allowance
- ▶ baste or pin zipper in place so that fabric folded edges meet over the center of the zipper

With Straight Stitch no. 1

- ▶ open zipper a little
- ▶ start sewing from top left
- ▶ position the foot so the needle stitches along the edge of the zipper coils
- ▶ stop in front of the pull (needle position down), raise the presser foot and close zipper again
- ▶ continue to sew to the base of the zipper (needle position down)
- ▶ turn fabric and sew across the seam (needle position down)
- ▶ turn fabric again and sew second side of the zipper from bottom to top



- ▶ Zipper foot no. 4D
- ▶ Zipper foot with guide no. 14 (optional accessory)

Variation

Sew both sides of Zipper from bottom to top

- ▶ suitable for all fabrics with nap or grain (e.g. velvet)
- ▶ prepare zipper as described above
- ▶ start sewing in the seam of the zipper end and sew first side from bottom to top
- ▶ sew the second side the same way from bottom to top



Zipper as a decorative element

- ▶ sew a visible zipper into the fabric as a decorative element

To sew around the zipper pull

- ▶ close the zipper and sew up to about 2" (5cm) away from the pull
- ▶ stop with the needle down in the fabric, raise the presser foot. Open zipper, pulling the tab below the needle; lower presser foot and continue to sew

Starting to sew

- ▶ hold threads firmly when starting to sew and pull the fabric gently behind the needle for a few stitches

Zipper tape or firm fabric

- ▶ for even stitch formation use a size 90 - 100 needle

Important Information



If a buttonhole is to be sewn at right angles to a seam, we recommend the use of the height compensation plates for buttonholes (available as optional accessory).

Using the compensation plate is recommended when sewing buttonholes in difficult fabrics. It can be used with the Automatic buttonhole foot no. 3A or the buttonhole foot 3B.

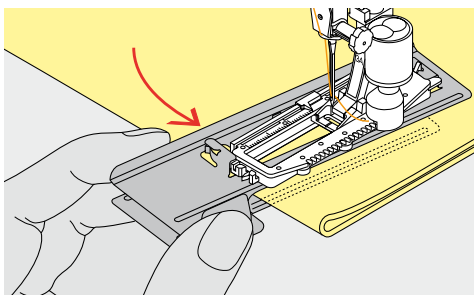
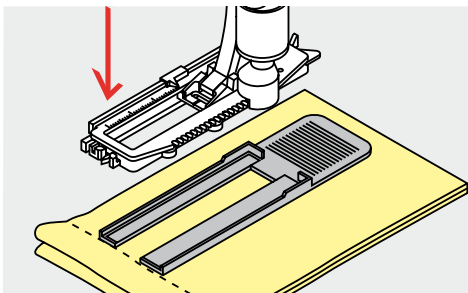

Thread Tension

- ▶ the tension is set automatically when a buttonhole is selected
- ▶ the upper tension is slightly looser than normal
- ▶ this gives a slightly rounded appearance to the beads, making the buttonhole more attractive
- ▶ cord reinforces buttonholes and enhances their appearance
- ▶ sew both beads at the same speed

Test Sewing

- ▶ always sew a test sample on the fabric with stabilizer you intend to use
- ▶ select the buttonhole type you intend to use
- ▶ sew the buttonhole in the same direction on the fabric (with or against the grain)
- ▶ cut the buttonhole open
- ▶ push the button through
- ▶ adjust the buttonhole length if necessary

Corrections

To Adjust the Bead Width

- ▶ alter the stitch width

Altering the Stitch Length

- ▶ any alterations to the stitch length affect both beads (more dense or less dense)
- ▶ always reprogram the buttonhole after any changes to the stitch length

Preparation

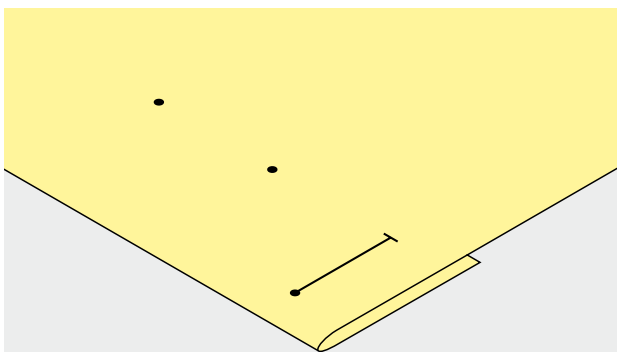
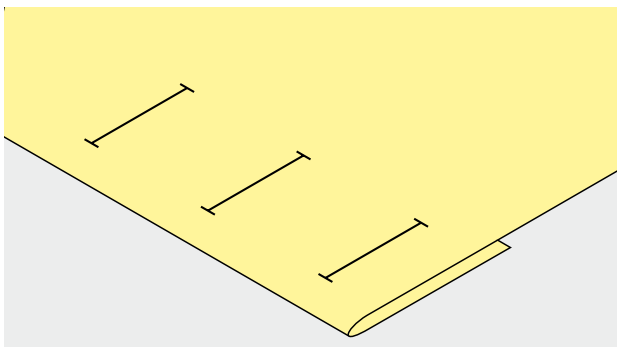

Manual Buttonholes

- ▶ mark the buttonhole length in the desired position
- ▶ use Buttonhole foot no. 3C (optional accessory)

Automatic Buttonholes

- ▶ mark the length of just one buttonhole
- ▶ after sewing the first buttonhole, the length for all subsequent buttonholes is automatically programmed
- ▶ mark only the beginning of all subsequent buttonholes
- ▶ use Automatic buttonhole foot no. 3A

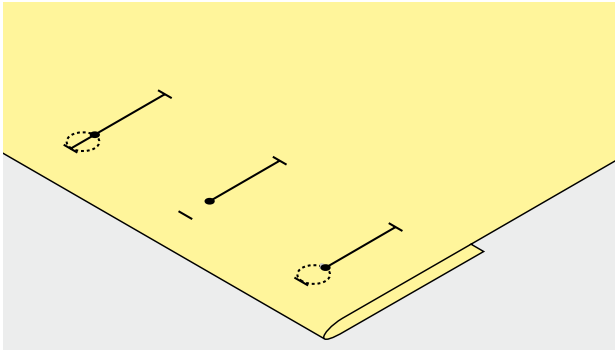

Keyhole Buttonholes

- ▶ mark the bead length only
- ▶ the correct eye length will be added when the buttonhole is sewn

Stabilizers and Interfacings



Automatic Buttonholes

- ▶ interfacing helps with stability and with the buttonhole durability
- ▶ select the interfacing to suit the fabric type

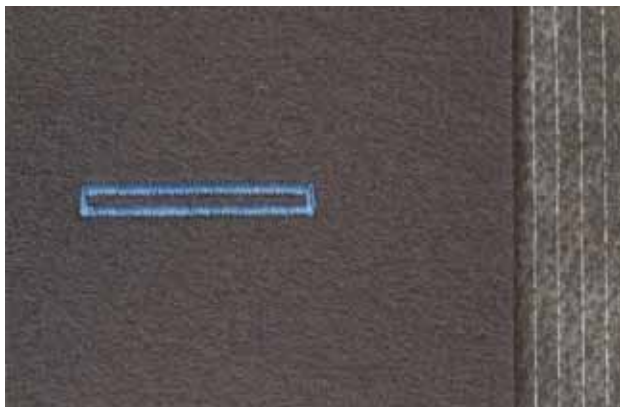

- ▶ for thick and fluffy fabrics an embroidery stabilizer can be used. The fabric feeds better

Corded Buttonholes

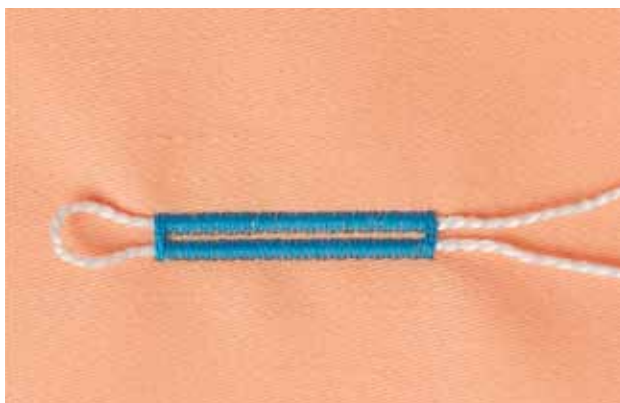

General

- ▶ cord reinforces and enhances the appearance of buttonholes with raised beads
- ▶ the loop of the cord should be at the end of the buttonhole most subject to wear = where the button rests
- ▶ position the work accordingly

Ideal Cords

- ▶ perle cotton no. 8
- ▶ strong hand-sewing thread
- ▶ fine crochet yarn

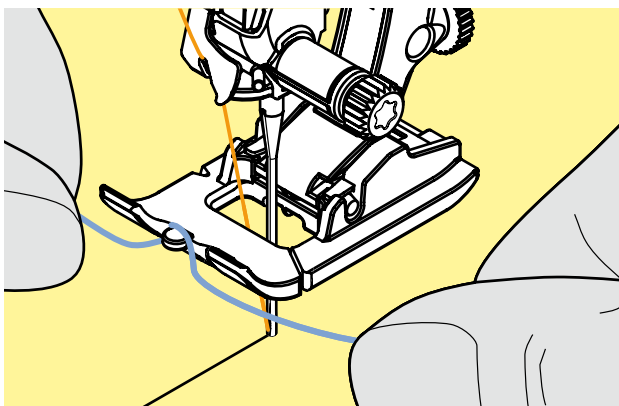

Corded Buttonholes With Presser Foot no. 3C (optional accessory)

- ▶ insert the needle at the beginning of the buttonhole
- ▶ raise the presser foot
- ▶ hook the cord over the center pin on the front of the foot

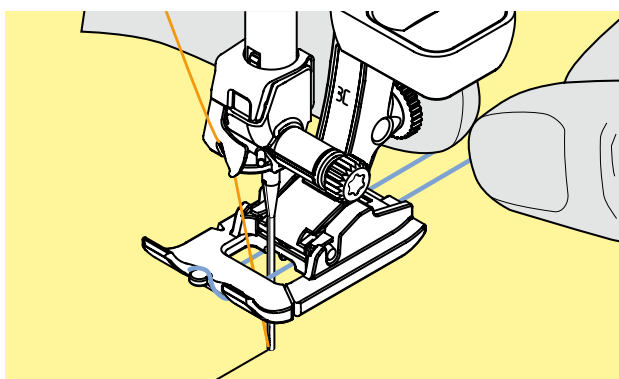

- ▶ place both ends of the cord in the grooves on the sole of the foot and pull them to the back
- ▶ lower the presser foot

Sewing

- ▶ sew the buttonhole in the usual manner, do not hold the cord tightly
- ▶ the buttonhole will form over the cord, covering it

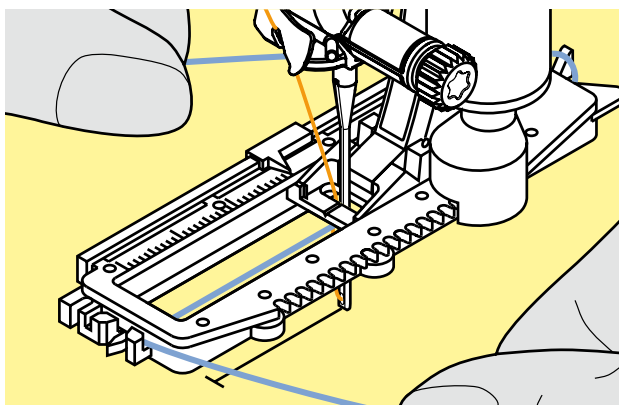

Corded Buttonholes With Buttonhole Foot no. 3A

- ▶ insert the needle at the beginning of the buttonhole
- ▶ raise the presser foot
- ▶ guide the cord under the foot to the right
- ▶ hook the cord over the pin at the back of the foot

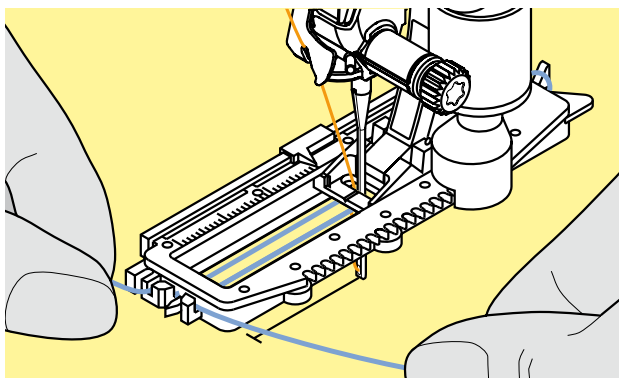

- ▶ bring the cords to the front of the foot
- ▶ pull them into the slit

Sewing

- ▶ sew the buttonhole in the usual manner, do not hold the cord tightly
- ▶ the buttonhole will form over the cord, covering it



Narrowing bead width could affect coverage of cording.

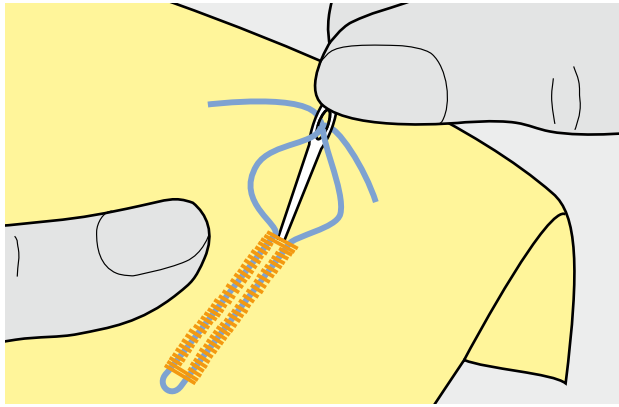

Securing the Cord

- ▶ pull the cord through the buttonhole until the loop disappears into the end of it
- ▶ pull the ends of the cord through to wrong side of the fabric
- ▶ knot or secure with stitches

Cutting Open the Buttonhole

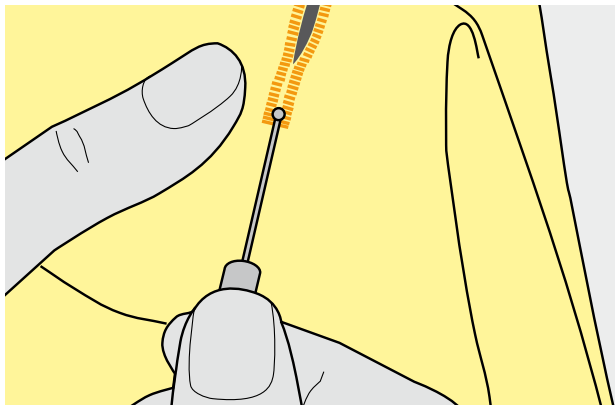

Seam Ripper

- ▶ using the seam ripper, cut from the ends towards the middle



In order not to cut the ends of short buttonholes by mistake, place a pin at the end of the buttonhole for additional security.

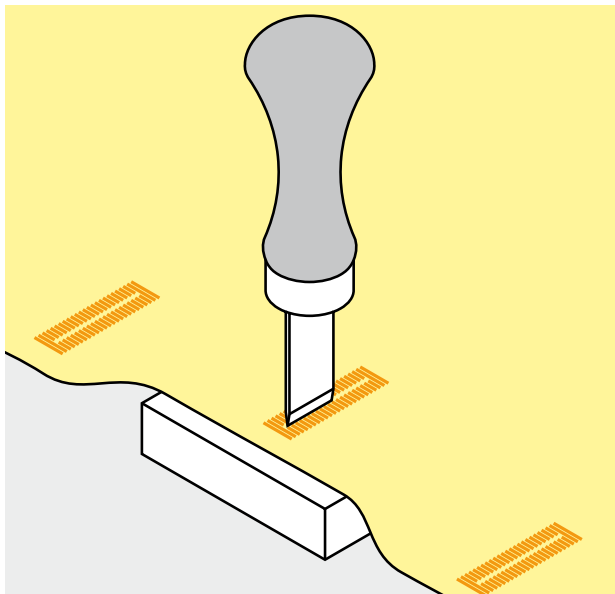

Buttonhole Cutter and Block (optional accessory)

- ▶ place the fabric on the wood block
- ▶ place the cutter in the center of the buttonhole
- ▶ press down on the cutter with your hand or a hammer

Cross Stitches

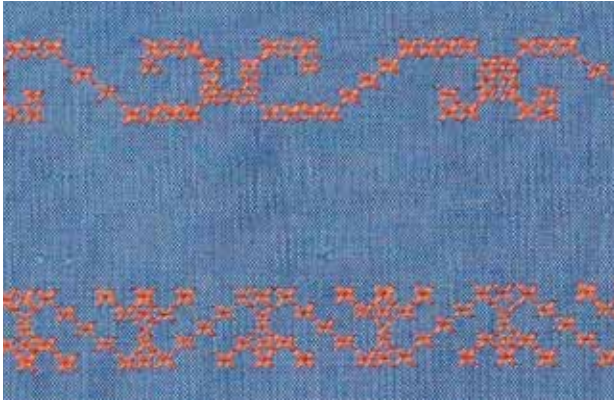

- ▶ cross stitching is a traditional technique, and extends the range of decorative stitches
- ▶ if the cross stitches are sewn on fabric with a linen texture, they acquire a hand-stitched effect and look like hand-stitched cross stitching

Application

- ▶ for home furnishings
- ▶ for trimmings on garments
- ▶ for embellishing in general

Sewing

- ▶ cross stitches of Category 300 can be stitched and combined like any other decorative stitches

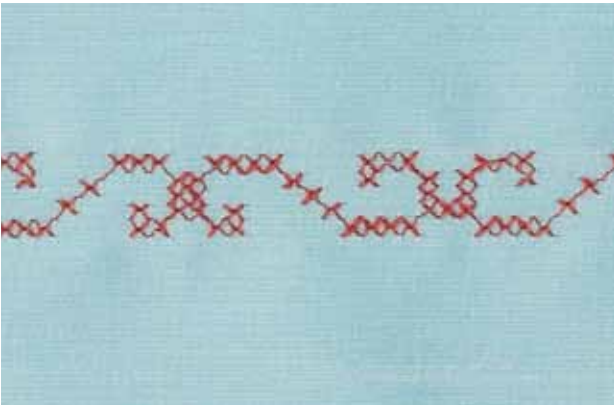

Sewing Trims

- ▶ select cross stitch
- ▶ stitch a row, using the seam guide or slide-on table seam guide
- ▶ it is important to stitch the first row in a straight line, as it will serve as a reference for the rows that follow
- ▶ select a new stitch
- ▶ stitch a second row next to first at a distance of one presser foot's width, or using the seam guide
- ▶ repeat for the following rows of stitching



Use cotton embroidery thread for cross stitching
Stitch appears fuller.



- ▶ Reverse pattern foot no. 1C/1D or
- ▶ Open embroidery foot no. 20C/20D

Bobbin-Play Sewing

Free Motion Sewing

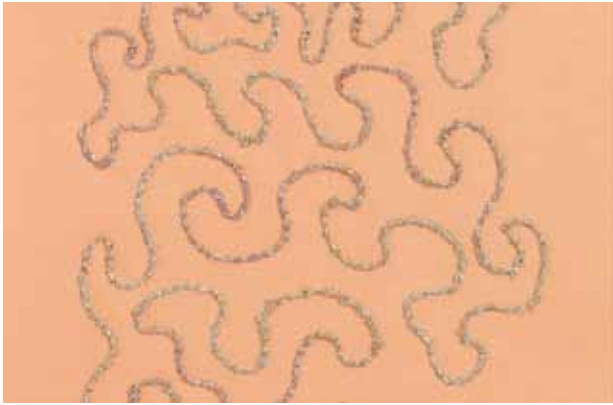

Reduce the winding speed to wind decorative threads on the bobbin.

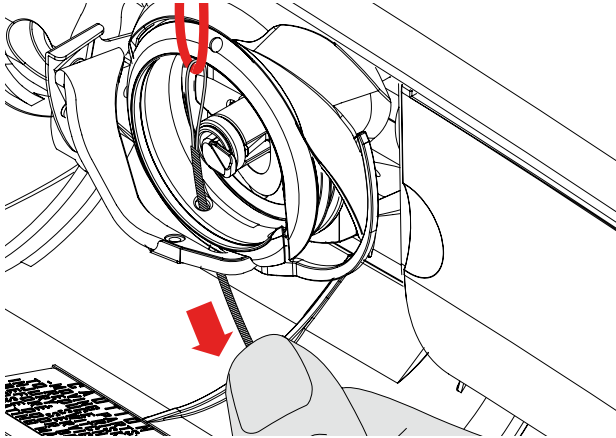

The bobbin can be filled with different thread, ribbons or cords, e.g. perle yarn and metallic threads, narrow satin ribbon, elastic threads and wool threads for free-motion stitching to add texture. This method is similar to “normal” free-motion sewing, but is done on the wrong side of the fabric.

Depending on thread thickness, use the tool contained in the accessories to loosen the lower-thread tension (see page 25). Very thick thread must be wound onto the bobbin by hand (clockwise), then drawn through the hole in the hook with the threader (in accessories).

Reinforce the area to be sewn with embroidery stabilizer. The design can be drawn on the wrong side of the fabric. You can also draw the design on the front of the fabric, then follow the lines with a freely guided straight stitch and polyester, cotton or rayon thread. The rows of stitching are visible on the right side of the fabric, and serve as reference lines for the bobbin-thread sewing.

The BSR function can be used for bobbin-thread sewing. Guide your project at uniform speed evenly under the needle, follow the lines of the design, and fill shapes as wished. Remove the stabilizer after you finish sewing.

Sew a sample first to check what the result looks like on the wrong side of the fabric. Alter the lower-thread or upper-thread tension if required.

Decorative Stitches

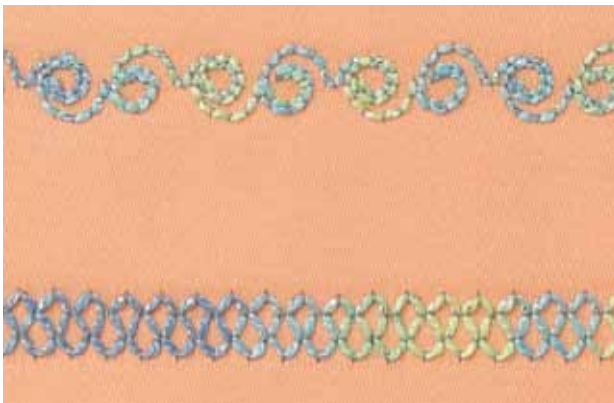

The bobbin can be filled with different threads or ribbons, e.g. perle yarn and metallic threads, narrow satin ribbon, elastic threads and wool threads for bobbin-play sewing with decorative stitches.

Not all decorative stitches are suitable for this technique. Avoid compact stitch types and satin stitches.

Open embroidery foot no. 20C or 20D is ideal for this technique.

- ▶ adjust stitch length and width settings (widen, lengthen) so that nice results are also achieved when sewing with thicker threads
- ▶ the long-stitch function produces another decorative effect

Tapering

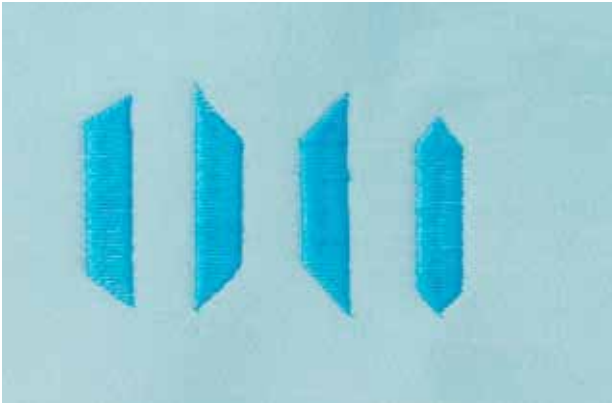

Use the tapering function to create decorative frames and boxes. Select one of the tapering stitches, then the edge alignment of the taper (left). At the end of the first row, program the desired length, pivot your project and sew the following rows or sides in the same manner.



Use the functions Needle Stop Down and raise Presser Foot when pivoting your project in the corners of the design.

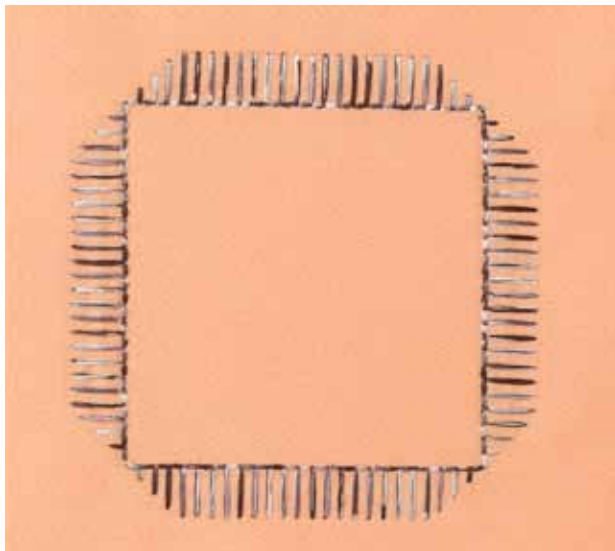
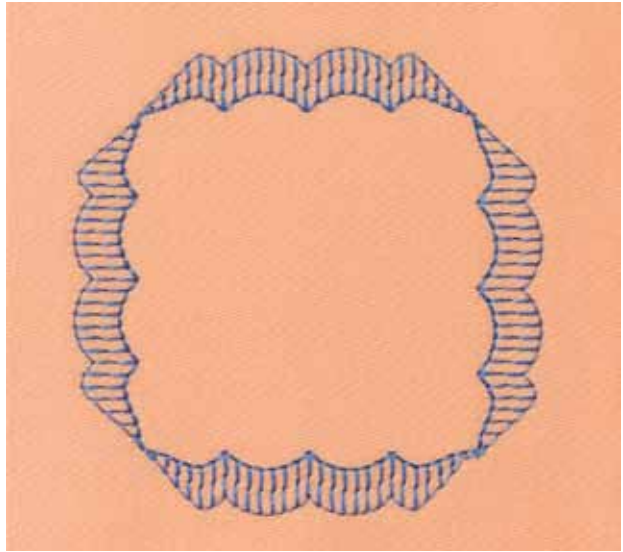
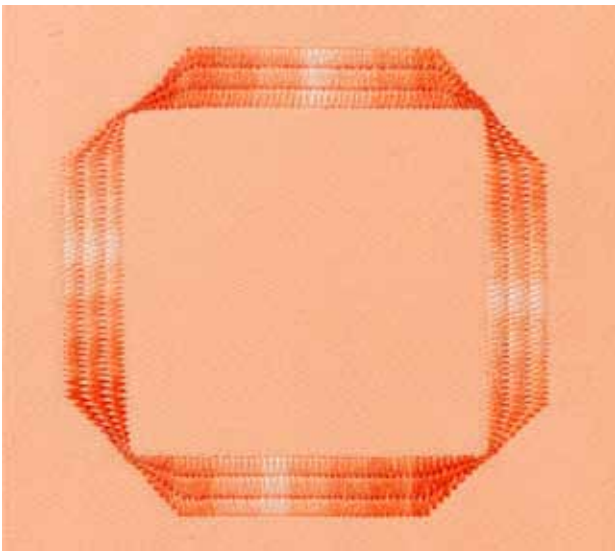

Certain tapering stitches are more appropriate for geometric applications, please sew a test sample before sewing your project.

Sewing Pin Tucks

Sew delicate and decorative pin tucks easily with the cording attachment. The tube on the attachment provides ample room for a cord to be inserted for sewing raised pin tucks.

Attach it simply by screwing it to the stitch plate with the screw provided.

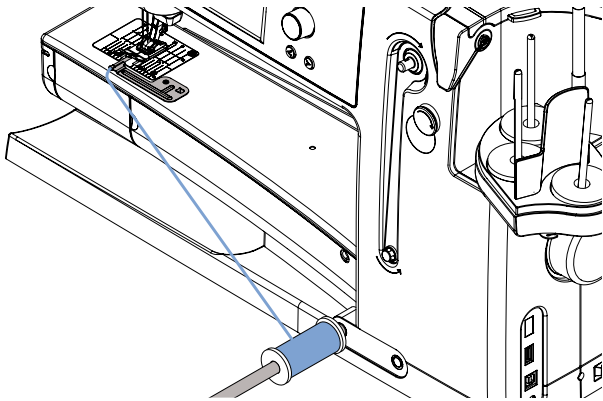
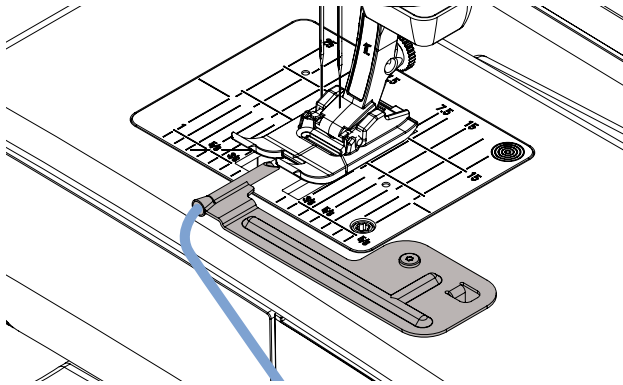

To help with even flow of cording, put the cord spool on the Free Hand System, so it doesn't fall on the floor or tangle while you're sewing.

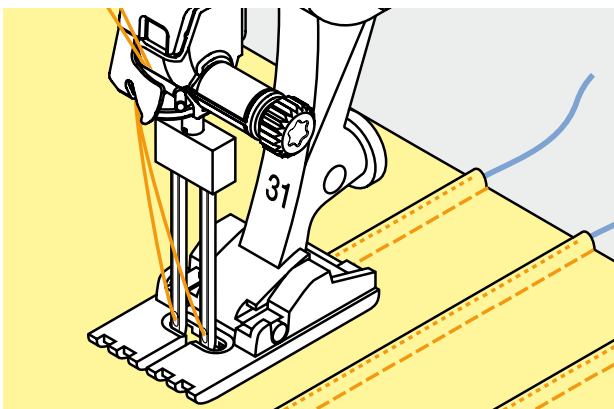

Sewing

- ▶ place the fabric under the foot
- ▶ begin sewing, the cording is automatically sewn into the pin tucks creating a raised effect
- ▶ you can also use the pin tuck attachment for a beautiful scallop off the edge finish on collars, cuffs and tucks

Quilt Techniques

Quilt Labels



- ▶ creating personal labels for your quilts
- ▶ use the Quilt Alphabet in Combi mode to program lettering, such as your name, your quilts' titles or other information
- ▶ embellish the lettering with decorative stitch patterns

Free Motion Quilting



- ▶ for all freehand quilt work

Preparation

- ▶ pin and baste top layer, batting, and backing together
- ▶ attach the slide-on table

Holding the Work

- ▶ hold the fabric with both hands like an embroidery frame
- ▶ start in the center and work out toward the edges

Quilting a Design

- ▶ guide the work using smooth, round movements to form the design of your choice

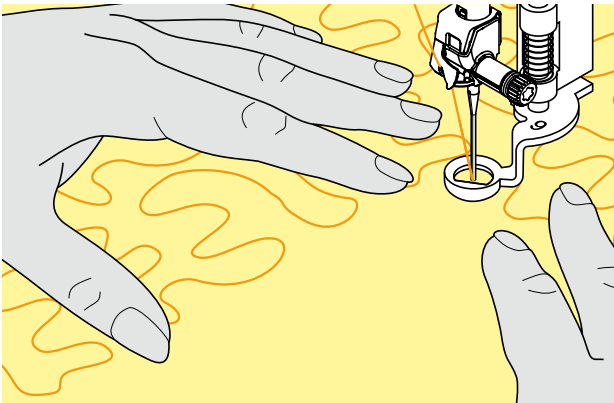

Stipple Quilting

- ▶ technique covers the entire surface of the fabric
- ▶ the lines of stitching are rounded without any sharp corners; they never cross nor touch one another



▶ Darning foot no. 9



Free Motion Quilting and Darning

The two techniques are based on the same Free Motion principles.

Poor Stitch Formation

- ▶ if the thread forms loops, the work is being moved too quickly
- ▶ if knots are forming on the wrong side, the work is being moved too slowly
- ▶ place fabric in a hoop for easier guiding

Monofilament thread breaks

Reduce the motor speed and/or loosen the upper thread tension.

Thread breaks

Inconsistent feeding of fabric.

BSR (BERNINA Stitch Regulator) Function

The BSR presser foot reacts to the movement of the fabric under the foot and controls the speed of the sewing computer up to the maximum speed possible. The following applies: the faster the fabric is moved the higher the speed of the sewing computer.

If the fabric is moved too fast an acoustic signal (beep) is heard, and the red light of the Start-/Stop Button flashes. The beeper can be turned on or off in the Setup Program or directly on the «BSR» screen.



With Straight Stitch no. 1

This function using a special presser foot allows for Free Motion quilting (sewing) using the straight stitch and a pre-selected stitch length (up to 4mm).

A regulated set stitch length is maintained within a certain speed, independent of the movement of the fabric.

With Zigzag Stitch no. 2

The zigzag stitch can be used for thread painting or fabric embellishment.

The set stitch length will **not** be maintained when sewing with the zigzag stitch, but the BSR function simplifies the application.

BSR function can be sewn in 2 separate modes of operation

- ▶ BSR mode 1 is the active standard
- ▶ the sewing computer runs continuously at a reduced motor speed, as soon as the foot control or the Start/ Stop Button is pressed
- ▶ moving the fabric under the foot will engage the sewing computer to accelerate
- ▶ through the continuous needle movement securing in the same position is possible without pressing an additional button
- ▶ touch the button «BSR2» to engage BSR mode 2
- ▶ the sewing computer will only engage if the foot control or the Start/Stop Button is pressed and the fabric is moved simultaneously
- ▶ the movement of the fabric determines the sewing speed
- ▶ for securing, the «Securing Function» button must be pressed
- ▶ touch the button «BSR1» to engage BSR mode 1



By activating the BSR function the sewing computer sews either continuously at a reduced motor speed (mode 1, standard), or as soon as the fabric is moved (mode 2). As long as the BSR presser foot is illuminated red, adjustments like threading and changing the needle, for example must not be carried out, as the needle will engage while fabric is moved unintentionally! Without fabric feed the BSR mode is turned off after approx. 7 seconds and the red light goes off. Please refer to the Safety Instructions!



When exceeding a certain speed, adhering to regular stitch length cannot be guaranteed.

Make sure that the lens on the bottom of the BSR foot is not dirty (fingerprints, etc.). Clean lens periodically with soft, slightly damp cloth.



For an even sewing start (one single stitch) the foot control must be pressed and the fabric moved simultaneously. This also applies for sewing points and straight stitching within a round form.

If the BSR function is deactivated and later re-activated without the sewing computer being switched off in between, the last selected BSR mode is active.

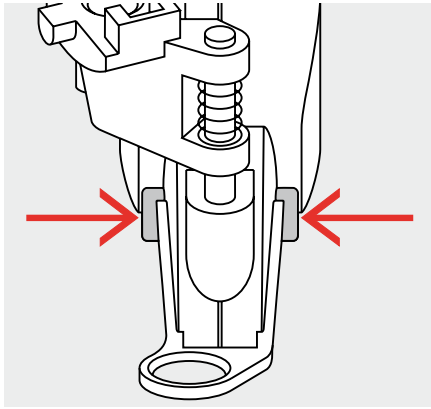

Preparation

- ▶ use Slide-on table
- ▶ attach the desired presser foot sole to the BSR Presser Foot
 - ▶ removing sole: press both buttons (see arrows) on each side of the foot
 - ▶ slide the sole down the groove at an angle
 - ▶ attaching the sole: slide the sole up in the groove until it clicks into place



Presser Foot Pressure may be reduced depending on the fabric type and thickness.

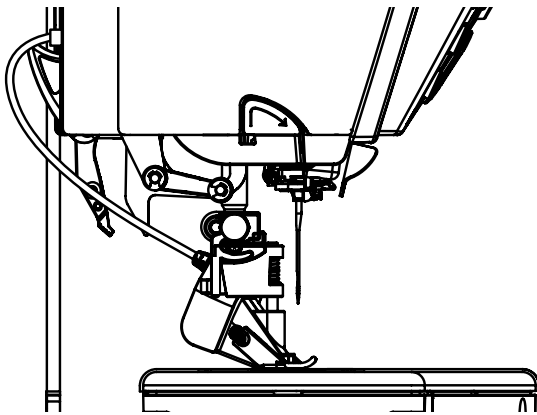

- ▶ attach the BSR Presser Foot to the sewing computer and plug the cable in the outlet provided

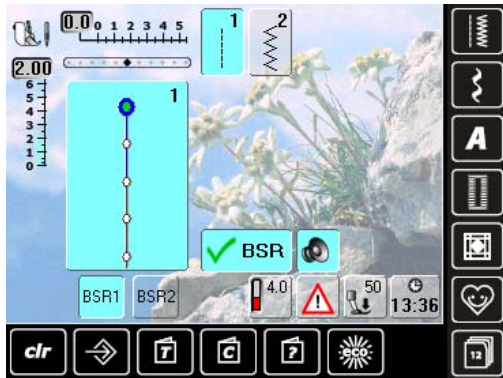

- ▶ the «BSR» screen opens automatically
- ▶ the BSR mode 1 is activated (BSR1 is standard)
- ▶ the basic stitch length setting is 2mm
- ▶ set the desired stitch length
- ▶ when sewing small forms and stippling, stitch length of 1mm - 1.5mm is suggested

Needle Stop Down (Default)/Up

- ▶ the arrow points down on the display = the sewing computer stops with needle down, when taking foot off foot control or engaging the Start/Stop Button
- ▶ press the needle stop button until the arrow points up = the sewing computer stops with needle up, when taking foot off foot control or engaging the Start/Stop Button

Raise or Lower the Needle

- ▶ press the needle stop button - or by pressing the heel on the foot control, the needle can be lowered or raised

Securing With the Start/Stop Button (only Mode 1)

- ▶ unplug the foot control
- ▶ place the fabric under the presser foot, lower presser foot
- ▶ hold upper and lower thread and start the BSR mode by pressing the Start/Stop Button
- ▶ sew 5 to 6 securing stitches
- ▶ stop the BSR mode by pressing the Start/Stop Button
- ▶ cut threads
- ▶ re-start the BSR mode by pressing the Start/Stop Button to continue the stitching process

Securing Function (only Mode 2)

- ▶ press the «Securing Function» button
- ▶ press the foot control/Start/Stop Button
- ▶ short securing stitch sequence are sewn as soon as the fabric is moved under the presser foot. After the sequence is sewn the set stitch length will be activated and the securing function will be automatically deactivated

Free Motion Quilting (only Mode 2)

- ▶ the BSR mode is activated
- ▶ freemotion quilting can be sewn
- ▶ when the securing function button is pressed during free hand quilting, a short securing stitch sequence is sewn and the sewing computer will stop sewing automatically
- ▶ the BSR mode is deactivated

Free Motion Quilting without BSR activation

- ▶ touch the BSR button (on the left side on the display)
- ▶ the BSR mode is deactivated, the buttons «BSR1» and «BSR2» on the left side on the display go off
- ▶ normal freemotion quilting can now be sewn with the BSR foot, without automatic regular stitch length

Beeper (Acoustic Signal) Deactivation/Activation



Opening Setup Program

- ▶ press the Setup button
- ▶ selection menu appears
- ▶ touch «5»
- ▶ the screen «Audio Settings» appears



Selecting Sound for BSR in the Setup Program

- ▶ one sound is set as default
- ▶ touch the bar with the speaker icon for BSR one time
- ▶ if the bar is gray and the speaker is red, the sound for the beeper is inactive
- ▶ if the bar is blue, the sound for the beeper is active
- ▶ if the sounds in the Setup Program are generally turned off (field on left side of screen is gray, speaker is red), the icon with the speaker of the «BSR» bar is not visible

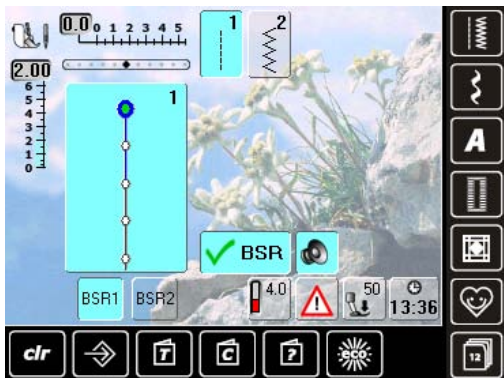

Selecting Sound for BSR on the «BSR» Screen

- ▶ touch the bar with the speaker icon for BSR one time
- ▶ if the bar is gray and the speaker is red, the sound for the beeper is inactive
- ▶ if the bar is blue, the sound for the beeper is active



Generally, the sound selection icon is only visible if the sounds are turned on in the Setup Program.

Activating the BSR Sewing Function:

1. With the Foot Control

- ▶ plug in the foot control
- ▶ lower the presser foot
- ▶ start the BSR mode by pressing the foot control
- ▶ a red light appears on the presser foot
- ▶ the foot control must be pressed continuously during sewing
- ▶ the speed of the sewing computer will be regulated by the movement of the fabric
- ▶ by releasing the foot control the BSR mode stops

2. With the Start/Stop Button

- ▶ lower the presser foot
- ▶ start the BSR mode by pressing the Start/Stop Button
- ▶ a red light appears on the presser foot
- ▶ the speed of the sewing computer is regulated by the movement of the fabric
- ▶ by re-pressing the Start/Stop Button the BSR mode stops

Deactivating the BSR Sewing Function by using the Start/Stop Button

Mode 1:

- ▶ if the fabric is not moved for approx. 7 seconds, the BSR mode is deactivated and the red light on the presser foot goes off

Mode 2:

- ▶ if the stitching process is ended by no longer moving the fabric, one additional stitch is made depending on the needle position. The sewing computer always stops with the needle up, even if the arrow on the display points down

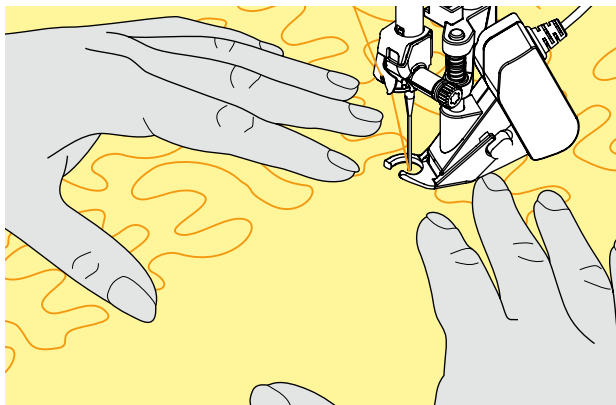

Holding the Work

- ▶ hold and guide the taut fabric with both hands
- ▶ abrupt movements of the fabric (slowing down, speeding up respectively) can result in slightly too short or too long stitches
- ▶ continuous movement of the fabric (no abrupt movements) under the foot will provide best results
- ▶ move the fabric in one direction for best results

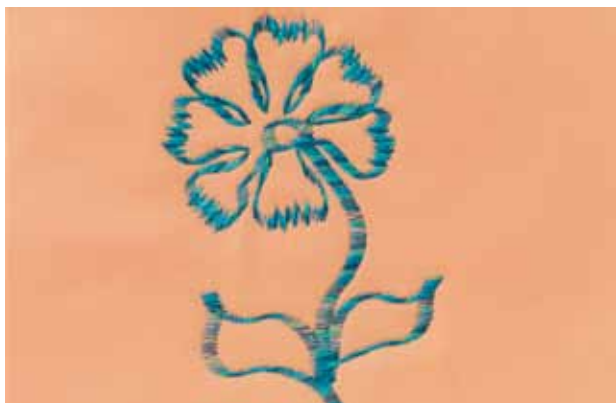

Application Example:

BSR With Zigzag Stitch no. 2

- ▶ the zigzag stitch can be used for thread painting or fabric embellishment for example
- ▶ areas can be filled and forms or pictures created

BSR Function Deactivation

- ▶ pull out the plug of the BSR presser foot connection cable on the sewing computer. The straight stitch no. 1 is active
- ▶ remove the BSR foot

BERNINA Dual Feed Description



Only use «D» presser feet with cut-out at the center back.
If an incorrect presser foot is attached, the sewing computer will not start with the dual feed engaged. An error message will appear.

With the BERNINA Dual Feed the top and bottom layer of fabric are fed simultaneously, the even feeding enabling perfect matching of striped and checkered patterns.

Presser Foot Selection

- ▶ Reverse pattern foot 1D (standard accessory)
- ▶ Zipper foot 4D (standard accessory)

More «D» presser feet are listed in the enclosed accessories catalogue.

Switching On BERNINA Dual Feed

- ▶ raise the presser foot
- ▶ press dual feed down until it engages

Switching Off BERNINA Dual Feed

- ▶ raise the presser foot
- ▶ hold dual feed on black holder with two fingers, pull it down, then push backward, slowly letting it slide upward



In order to ensure full functionality of the sewing computer, it is essential to **ALWAYS** lower the presser foot first thing after switching the dual feed ON or OFF.

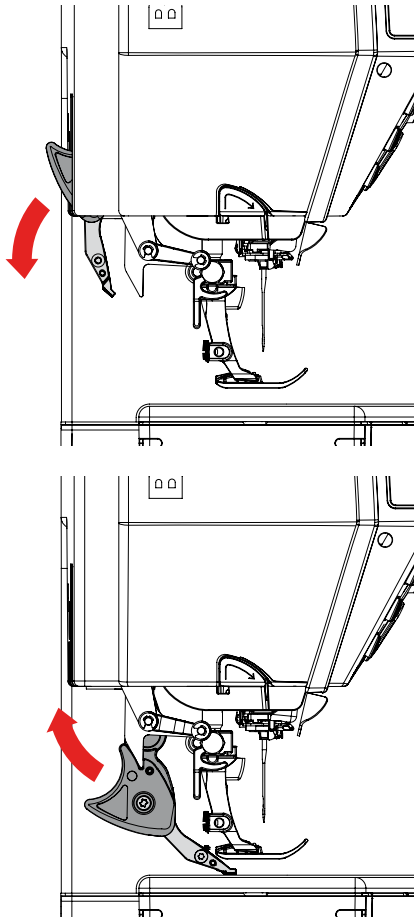

Fabrics

Difficult-to-work-with fabrics (with a nap, slippery, sticky etc.):

- ▶ velvet, normally sewn with the grain
- ▶ towelling
- ▶ Jersey, especially when sewing it crosswise to knit
- ▶ fake fur or coated fake fur
- ▶ fleece-types of fabrics
- ▶ batted fabrics
- ▶ stripes and checks
- ▶ curtain fabrics with pattern repeats

«Sticky» Fabrics

- ▶ imitation leather, coated fabrics (Teflon®-coated Dual Feed presser foot)

Application

Sewing

- ▶ all sewing techniques on difficult fabrics, e.g. hems, zippers

Patchwork

- ▶ accurate stripes and blocks
- ▶ decorative stitches up to 9mm stitch width

Appliqués

- ▶ Open embroidery foot 20D
- ▶ sewing on ribbons and bias-binding



Adjust the presser foot pressure to the fabric. The thicker the fabric the lower the presser foot pressure.

Use the Balance function for corrections, refer to page 52.

Maintenance Troubleshooting

Maintenance	116
Cleaning	116
Cleaning the stitch plate and the hook	116
Cleaning the automatic thread cutter	116
Lubricants	116
Cleaning the Screen and the Sewing Computer	116
Changing the Battery for digital Clock	117
Environmental Protection	117
Troubleshooting	118
Avoiding and Solving Problems	118
General Messages	122



Cleaning



Cleaning the stitch plate and the hook

Remove thread remnants and lint from under the stitch plate.

- ▶ remove presser foot and needle
- ▶ press the stitch plate down at the back right corner and remove
- ▶ open bobbin cover door
- ▶ remove the bobbin
- ▶ clean the stitch plate and the lower thread indicator with the lint brush or use a vacuum cleaner



- ▶ clean the hook and hook race with the lint brush. Do not use sharp instruments for cleaning!
- ▶ insert the bobbin
- ▶ close the cover
- ▶ replace the stitch plate

Cleaning the automatic thread cutter

- ▶ see page 46



Lubricants

- ▶ open bobbin cover door
- ▶ with your left hand, hold the bobbin-case; with your right hand, turn the hand wheel clockwise until the hook race is visible
- ▶ apply a tiny amount of universal sewing machine oil in the hook race
- ▶ close bobbin cover door
- ▶ briefly run the sewing computer in idle, so sewing project is not soiled

Cleaning the Screen and the Sewing Computer

- ▶ wipe with a soft, damp cloth



Turn power switch to «0» (off) and remove plug from electrical outlet when performing maintenance. Never use alcohol, petrol, white spirit or any type of solvent to clean the sewing computer.

Changing the Battery for digital Clock

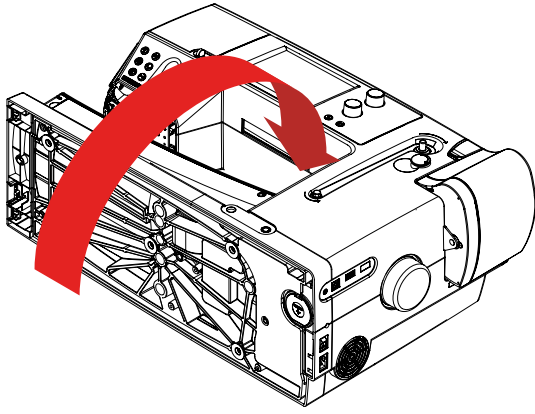

- ▶ only use a 3V coin cell battery, CR 2032. Use of another battery may present a risk of fire or explosion
- ▶ lie sewing computer on its back
- ▶ remove the battery compartment cover
- ▶ open the lock for the battery with a small screwdriver and remove it
- ▶ insert the new battery and press down at the back until the lock snaps into place
- ▶ close the battery compartment

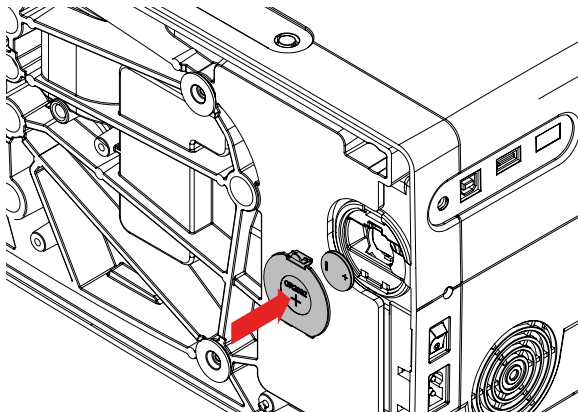
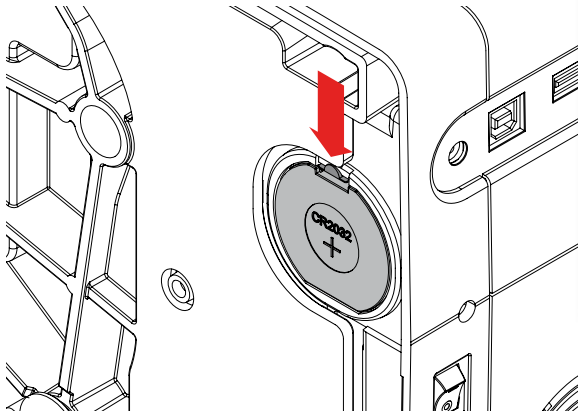

The battery used in this sewing computer may present a risk of fire or chemical burn if mistreated. Do not recharge, disassemble, heat above 100°C (212°F), or incinerate.

The battery should not be in reach of children. Do not use rechargeable batteries. Do not throw batteries into fire. Explosion hazard. Do not throw batteries into ordinary household waste; they should be placed in the public waste collection system.

Environmental Protection

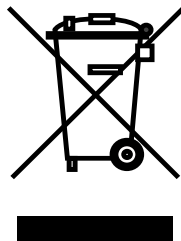

BERNINA is committed to the protection of the environment. We strive to minimize the environmental impact of our products by continuously improving materials used and our technology of manufacturing.

At end of life please dispose this product in an environmentally responsible way in accordance to the national directive. Do not throw away this product with your household waste. In case of doubt please contact your dealer.





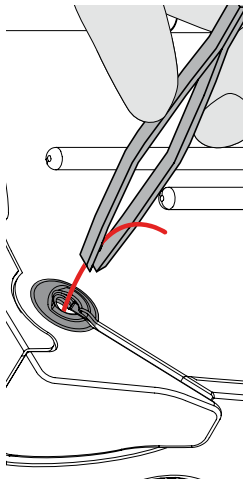

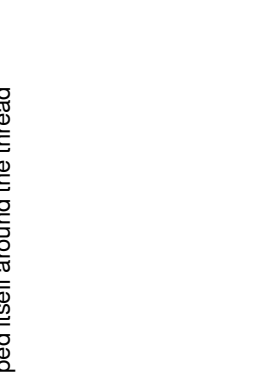

Some failures may be remedied by switching the sewing computer off, then on again after 10 seconds.

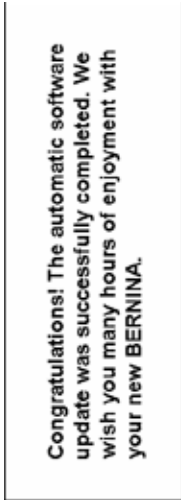
Fault	Cause	Repair
<p>Uneven stitch formation</p>	<p>Lower thread incorrectly threaded Upper thread incorrectly threaded Poor quality needle or bent Upper thread too tight/too slack Poor quality thread Lower thread too tight/too slack</p>	<p>Check lower threading path Check upper threading path Use a new, good quality needle (BERNINA) Reduce/increase upper thread tension Use quality threads (Isacord, Mettler, Gütermann) Reduce/increase lower thread tension</p>
<p>Skipped stitches</p>	<p>Incorrect needle system Needle bent or blunt Needle/thread combination is incorrect Needle inserted incorrectly Incorrect needle point Poor quality needle</p>	<p>Use needle system 130/705 H Use new, good quality needles (BERNINA) Match the needle to the thread size, see page 26 Insert needle as far up as it will go Match the needle type to the fabric Use good quality needles</p>
<p>Upper thread Breaks</p> 	<p>Upper thread tension too tight Incorrectly threaded Poor quality or old thread Stitch plate or hook tip damaged</p>	<p>Reduce upper thread tension Check upper thread threading path Use good quality thread Have the sewing computer checked by a dealer Remove any remaining threads in the pre-tension with tweezers and check the take up lever, see page 120</p>
<p>Lower thread breaks</p>	<p>Lower thread tension too tight Stitch hole in the stitch plate has been damaged Needle blunt or bent</p>	<p>Reduce lower thread tension Have the sewing computer checked by a dealer Use a new needle</p>

Fault	Cause	Repair
Needle breaks	Needle not correctly inserted Fabric is pulled Fabric was pulled when thick material used Poor quality thread with knots	Tighten the needle clamp screw Do not pull the fabric during sewing Use the correct presser foot for thick material (e.g. Jeans foot No. 8); use height compensating tool when sewing over a thick seam Use quality thread
Faulty Stitching	Remnants of threads between the tension discs of upper thread tension	Raise presser foot. Pull folded, thin fabric (do not use fabric edge) between the tension discs and clean them by moving the fabric sideways over the front and back of the thread tension disc
Screen does not respond	Calibration data incorrect ECO function switched on	Re-calibrate the screen in the Setup Program Turn off ECO function
Sewing computer fails to run or runs slowly	Plug not properly inserted Sewing computer is kept in a cold room Sewing computer is not switched on	Insert plug properly Place it in a warm room for 1 hour before use Turn on sewing computer (to «I»)
LED on the key does not light up	LED defective ECO function switched on	Have the sewing computer checked by a dealer Turn off ECO function
LED sewing light and free-arm light do not light up	LED defect ECO function turned on	Have the sewing computer checked by a dealer Turn off ECO function
Attached presser foot not recognised	Sensors (of presser foot, sewing computer) may be dirty	Clean sensors with a soft, slightly damp cloth

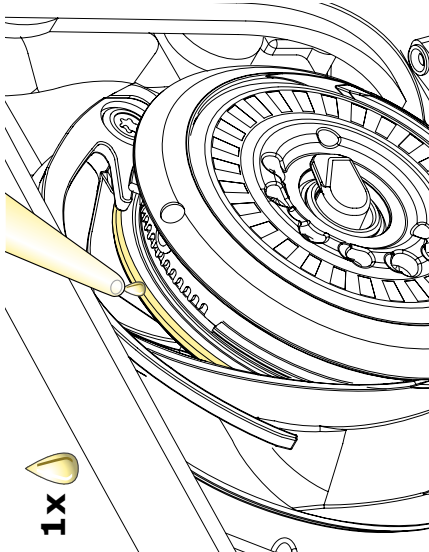
Fault	Cause	Repair
<p>Lower thread indicator does not respond</p>	<p>Bobbin damaged or defective Monitoring function is deactivated Defective sensors</p>	<p>Check bobbin or replace if required Activate monitoring functions in the Setup Program Have the sewing computer checked by a dealer</p>
<p>Update error</p>	<p>USB stick is not recognized Update process is at a standstill (hour glass remains)</p>	<p>Use a BERNINA USB stick Remove the stick and turn the sewing computer off and on again. Proceed with the update as indicated by the message</p>
<p>Thread is caught in the area of the take-up lever</p> 	<p>Upper thread breaks Upper thread slipped unvisibly back into the sewing computer and wrapped itself around the thread take-up lever</p>	<ul style="list-style-type: none"> ▶ Cut thread near bobbin ▶ Remove the cover to the left of the screen as follows: <ul style="list-style-type: none"> ▶ with your left hand, insert the multifunction tool in the slot on the left side of the cover and press the lock ▶ with your right hand remove the cover facing the front ▶ carefully remove thread remnants from the thread take-up lever/regulator with tweezers ▶ put on cover and press down at the back until it clicks into place
<p>Automatic thread cutter blocked</p>	<p>Thread remnants jammed in the thread Catcher</p>	<p>Under Cleaning in Setup Program, proceed as follows:</p> <ul style="list-style-type: none"> ▶ touch field 1 ▶ thread catcher of automatic thread cutter moves to the right ▶ carefully remove thread remnants with the tweezers ▶ touch field 3 ▶ automatic thread cutter re-initializes and is ready for use

Fault	Cause	Repair
Automatic threading not possible	Double-needle limitation is on Defective sensors	Switch off the double needle limitation in Security Program Sewing computer checked by a dealer
General Messages	Explanation Clean and lubricate sewing computer	Repair <ul style="list-style-type: none"> ▶ Open bobbin cover and remove bobbin ▶ Switch off sewing computer ▶ Remove presser foot, needle and stitch plate ▶ Clean sewing computer as indicated
	Deleting or overwriting data, e.g. Drawers	Confirm with ✔ or cancel with ✘
	Update successful	The sewing computer has been provided with the latest software version

General Messages	Explanation	Repair
	<p>Winding the bobbin</p>	<p>Wind bobbin as shown in the animations</p>
	<p>The sewing computer requires cleaning/lubrication.</p>	<p>To ensure that the sewing computer can operate at highest performance further on, it is time to remove lint and any thread and fabric remnants from under the stitch plate and around the feed-dog.</p> <p>This message appears after approx. 500,000 stitches. Close the message after cleaning/lubricating by touching the  field. The message can be deleted temporarily by touching the  field but will reappear when the sewing computer is next restarted. After the third deletion with  the message will not reappear before another approx. 500,000 stitches will have been stitched.</p>
	<p>After oiling bring the hook in the pictured position (see on the left) by turning the handwheel clockwise for correct threading.</p>	

General Messages

**It's time for your regular service.
Please contact your BERNINA dealer
for an appointment!**



Explanation



It is time for the scheduled, regular servicing. Please contact the BERNINA dealer/servicing to make a servicing appointment.

Repair

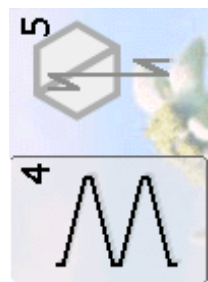
The sewing computer must be taken to an authorised BERNINA dealer/servicing shop. The message appears after approx. 3,000,000 stitches. Once the servicing has been performed by an authorised BERNINA dealer/servicing shop, the stitch counter is reset to «0» (zero) and the message disappears.

The message can be deleted temporarily by touching the **X** field but will reappear when the sewing computer is next restarted. After the third deletion with **X** the message will not reappear until the next reminder at approx. 6,000,000 stitches (in total). When the third message appears at 9,000,000 stitches (in total) servicing is imperative. The message reappears after each restarting of the sewing computer. Having your sewing computer cleaned and serviced properly at the appropriate times ensures its proper functioning and long service life. Failure to do so may adversely affect service life and limit the guarantee. The charge for servicing is nationally regulated – consult your dealer or servicing shop for details.

Error Message	Explanation	Repair
	<p>Stitch number not known in direct entry</p>	<p>Check command entered and enter a new number</p>
	<p>Stitch selection not possible in the combination mode</p>	<p>Make another selection</p>
	<p>Thread breakage</p>	<p>Check upper and lower threads</p>
	<p>Incorrect placement of bobbin</p>	<p>Place bobbin the other way round (white markings visible)</p>

Error Message	Explanation	Repair
	<p>Incorrect needle for the stitch plate selected</p>	<p>Check settings in securing program</p>
	<p>Needle is not in the highest position</p>	<p>Turn handwheel</p>
	<p>Main motor is not running</p>	<p>Remove any thread remnant from the hook area See also Blocked Hook on page 132-134</p>
<p>Not enough free storage space available for saving! Delete a few Designs to free up storage space.</p>	<p>Insufficient memory space in the sewing computer for the function selected</p>	<p>Reduce memory storage in Memory Reduce memory storage in Personal Program</p>

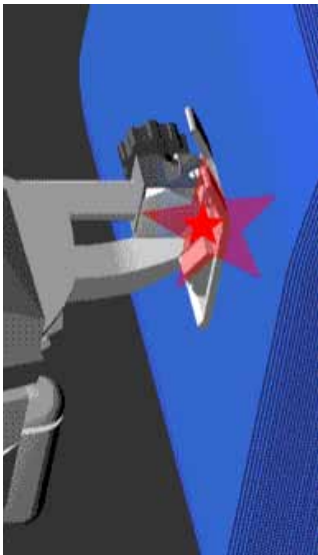

Error Message	Explanation	Repair
<p>Not enough free memory capacity on the BERNINA memory stick. Make sure that at least 10MB remain free on the BERNINA memory stick.</p>	<p>Less than 10MB free space on the USB stick</p>	<p>Delete data from USB stick</p>
	<p>Too much fabric under presser foot</p>	<p>Reduce amount of fabric under presser foot</p>
<p>No personal data on the memory stick.</p>	<p>No personal data available on the USB stick</p>	<p>Check that the USB stick is inserted correctly and re-start the sewing computer</p>
<p>The recovery of personal data was unsuccessful.</p>	<p>During the update process personal data was not saved on the USB stick</p>	<p>The software was correctly updated. Personal data could not be recovered</p>

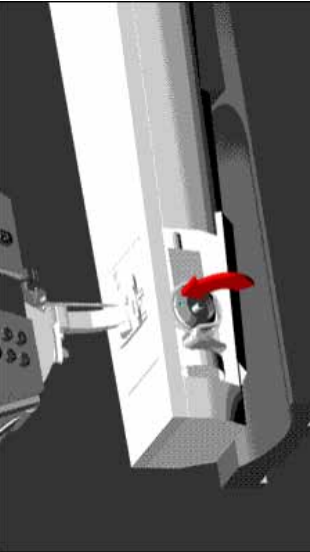
Error Message	Explanation	Repair
<p>Please insert the BERNINA memory stick. Make sure the same memory stick is inserted throughout the whole automatic software update process.</p>	<p>BERNINA USB stick is not inserted</p>	<p>Insert BERNINA USB stick and do not remove during the update process</p>
<p>The software update was unsuccessful.</p>	<p>New SW Version is not available on the stick</p>	<p>Save the new SW Version on the BERNINA USB stick and start the update again</p>
	<p>Bobbin cover not closed</p>	<p>Close bobbin cover slowly</p>

Error Message

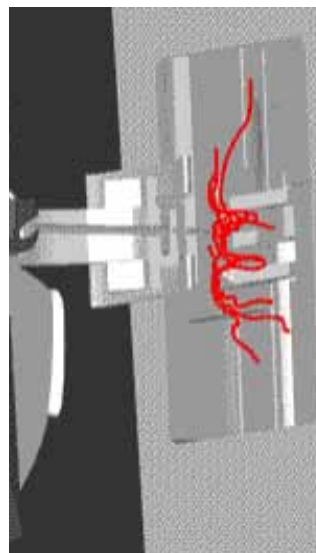
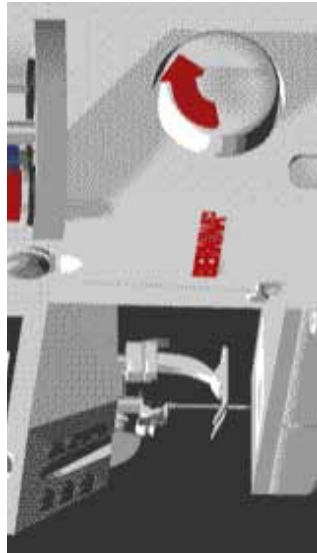
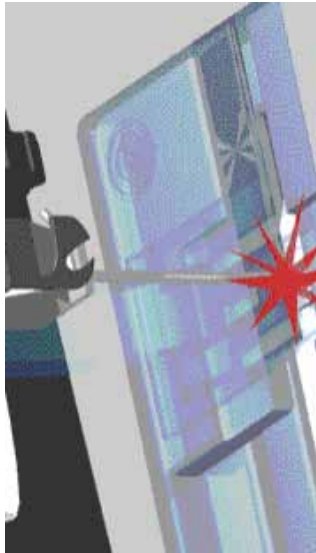

Explanation

Automatic Thread Cutter button touched and needle is blocked in lowest position

Repair

- ▶ Switch sewing computer OFF
- ▶ Turn handwheel clockwise until needle is in highest position
- ▶ Remove stitch plate
- ▶ Remove thread remnants
- ▶ Refit stitch plate, then switch sewing computer ON

Error Message	Explanation	Repair
	<p>Lower sensor is activated</p>	<p>Check bobbin and refill if required</p>
	<p>Upper thread run out</p>	<p>Attach fresh thread spool and threading</p>
	<p>Incorrect presser foot for BERNINA Dual Feed switched on</p>	<p>Attach a «D» presser foot</p>

Error Message	Explanation	Repair
	<p>Bobbin isn't inserted</p>	<p>Insert bobbin</p>
	<p>Threader doesn't move to starting position</p>	<p>Carefully raise threader manually</p>

Error Message

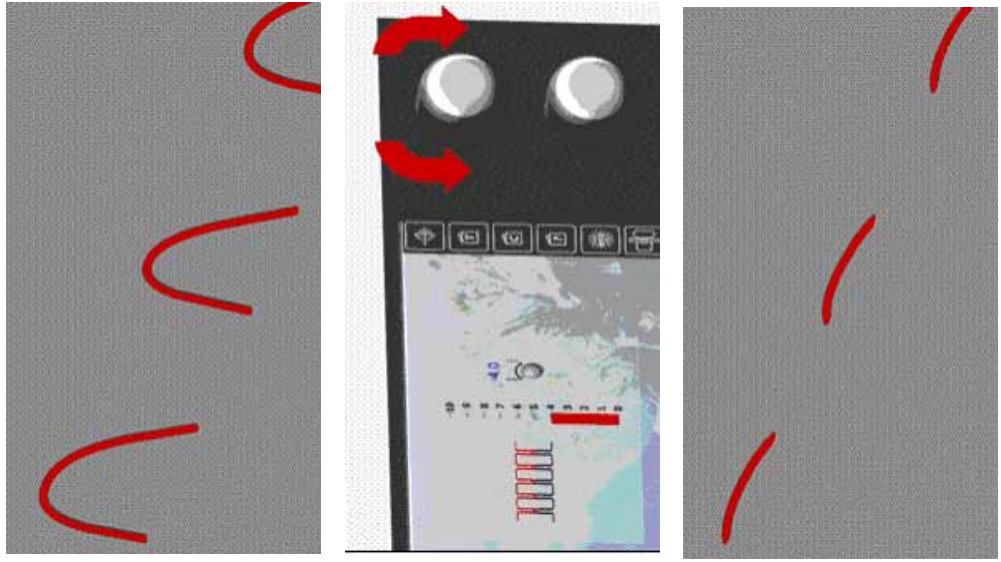

Explanation

Loose loop formation while sewing

Repair

Adjust thread tension in Thread Tension screen

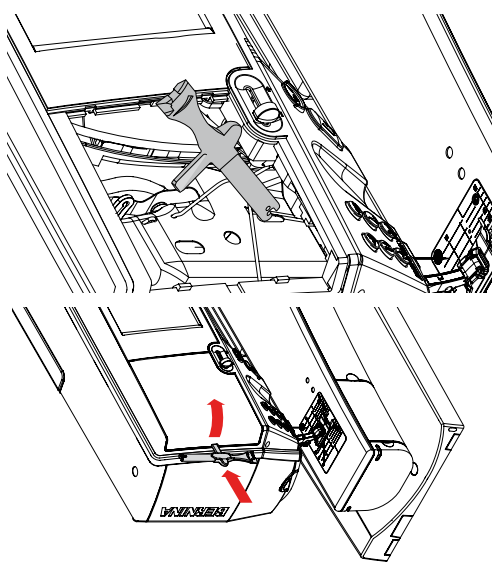
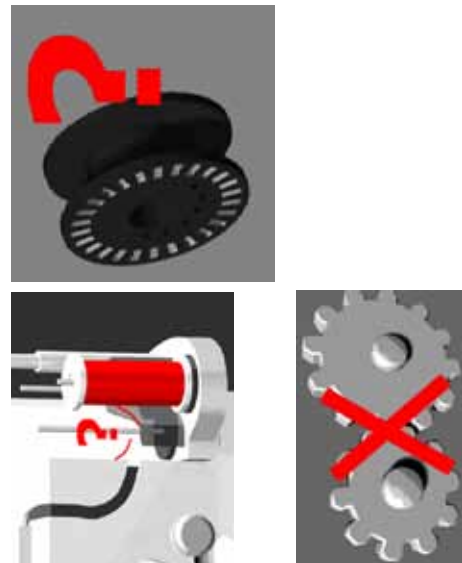
Error Message	Explanation	Repair
<p>Thread blockage in the hook with the needle down</p> 	<p>Thread is caught in the hook area</p>	<p>Remove the cover to the left of the screen as follows:</p> <ul style="list-style-type: none"> ▶ with your left hand, guide the multifunction tool into the slot on the left of the cover and press the lock ▶ with your right hand, remove the cover to the front at the same time ▶ with the multifunction tool, disengage the needle bar ▶ remove the needle ▶ replace cover and press to back until it clicks into place ▶ further procedure see «blocked hook»
<p>Blocked Hook</p> 	<p>Entangled threads in the hook system</p>	<p>The error messages listed here may be generated by various failures.</p> <p>Please follow this standard procedure in all the cases:</p> <p>Step 1 If the needle is not in its upmost position, raise needle by turning handwheel counterclockwise. If this doesn't work, cut upper thread, remove servicing cover and use the multifunction tool to release the needle bar and bring it up, see also «Thread blockage in the hook with the needle down»</p> <p>Step 2 Raise presser foot.</p> <p>Step 3 Use the scissors to cut the upper and lower thread above the stitch plate.</p> <p>Step 4 If bobbin door is not open, then open. Message «Manual mode for troubleshooting» appears with instructions.</p> <p>Step 5 Disconnect the foot controller.</p> <p>Step 6 Remove needle.</p> <p>Step 7 Swing hook out manually by turning the handwheel clockwise.</p>

Error Message

Explanation

Repair

- Step 8 Try to turn the handwheel clockwise until the blockade is undone. Use considerable force if required.
If this doesn't work, contact your BERNINA dealer.
- Step 9 Remove bobbin, cutting the thread if required.
- Step 10 Carefully remove any thread remnants with tweezers. If threads jam, slowly continue to turn handwheel clockwise, pulling the threads out as soon as they come free.
- Step 11 Bring the hook in the pictured position (see on the left) by turning the handwheel clockwise for correct threading.
- Step 12 Insert bobbin.
- Step 13 Check the lower thread tension (see on the left) by comparing the position of the lug with the figure in the bobbin door.
- Step 14 Swing hook in **completely** by turning the handwheel counterclockwise, then close bobbin door.
- Step 15 Check the needle. If it is flawless, re-attach it. If not, use a new needle.
- Step 16 Connect the foot controller again.
- Step 17 Confirm messages «Main mode for trouble-shooting» and «Main motor is not running» or «Check hook system».

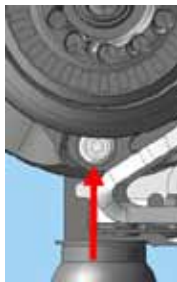

This tool may only be used for the application described!



Error Message

Blocked Hook

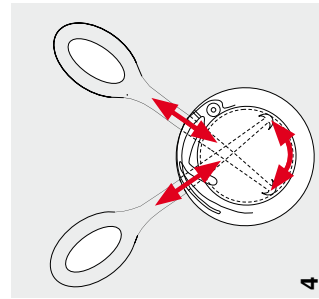
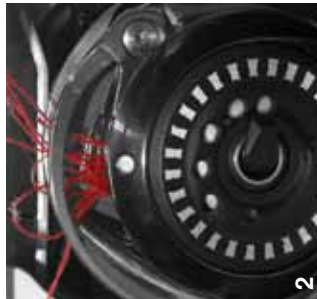
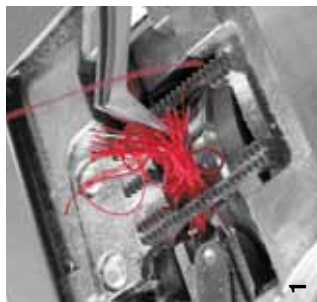

Repair

- ▶ cut the threads close to the stitch plate and remove the sewing project
- ▶ remove presser foot, needle and stitch plate
- ▶ open the bobbin door, the hook will swing out.
- ▶ switch sewing computer off.
- ▶ first use tweezers from the standard accessories and carefully remove the visible threads from the entire hook area (Fig. 1)
- ▶ hold bobbin case firmly with your left hand (see page 25 in the manual) and with your right hand turn the hand wheel to bring hook screw to the 2:30 position as shown Fig. 2
- ▶ carefully insert the tool into the opening, then pull the threads up and out by moving the tool sideways and upwards (Fig. 3-4)
- ▶ after removing all thread bits, lubricate the hook, then switch on the sewing computer and close the bobbin door. The hook will reposition itself automatically

BERNINA Stitch Patterns

Sewing Stitch Categories	136
Practical Stitches	136
Buttonholes	136
Decorative Stitches	136
Florals	136
Cross Stitches	136
Satin Stitches	137
Ornament Stitches	137
Heirloom Stitches	137
Novelty Stitches	138
Tassels	138
Quilt Stitches	138
Tapering Stitches	138
Alphabets	139
Block	139
Double Block	139
Script	140
Quilting Text	140
Kyrillic	141
Hiragana	141
Katakana	142
Kanji	142

Practical Stitches

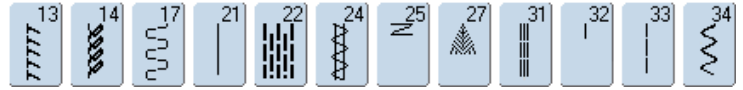
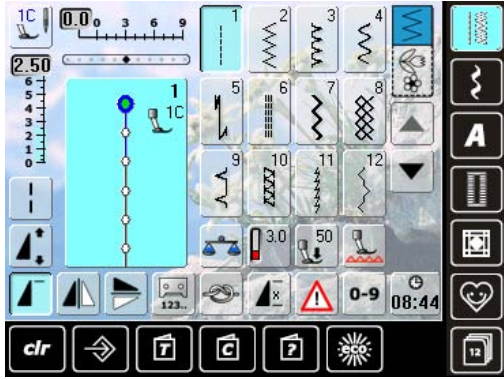

Buttonholes

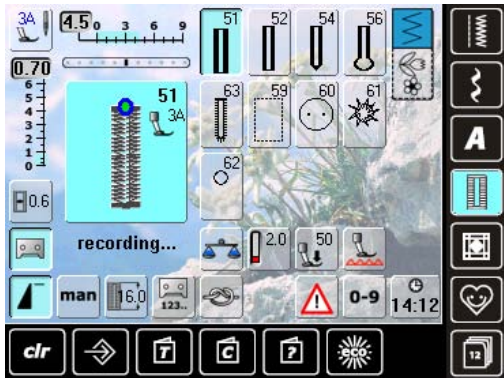

Decorative Stitches

Florals

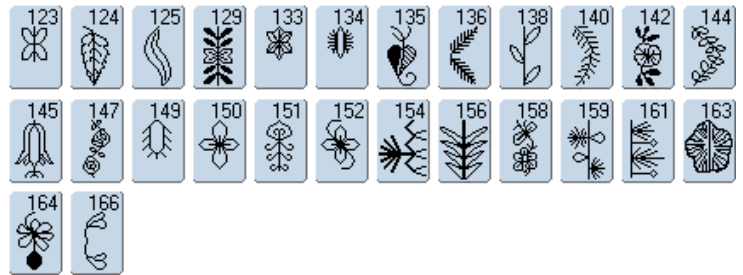
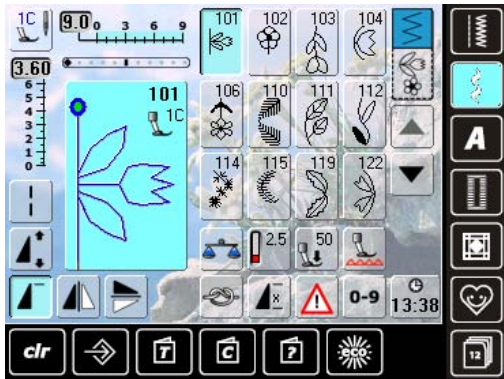

Cross Stitches

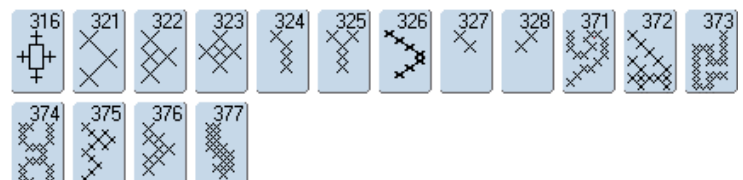

Satin Stitches

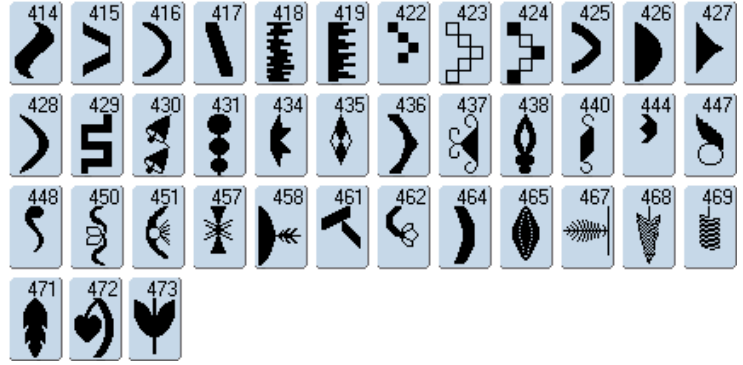

Ornament Stitches

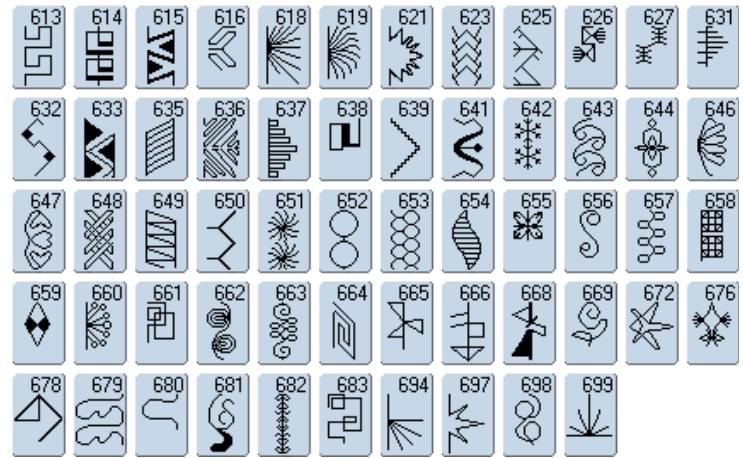
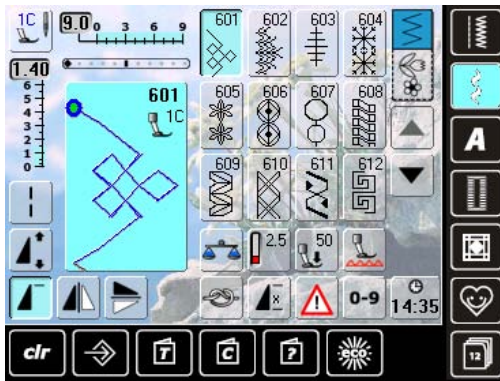

Heirloom Stitches

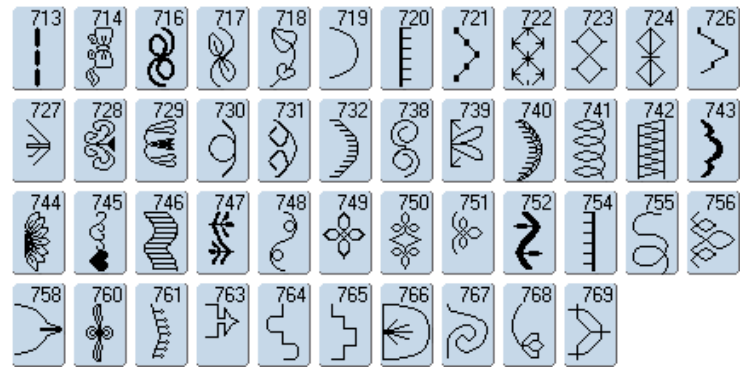
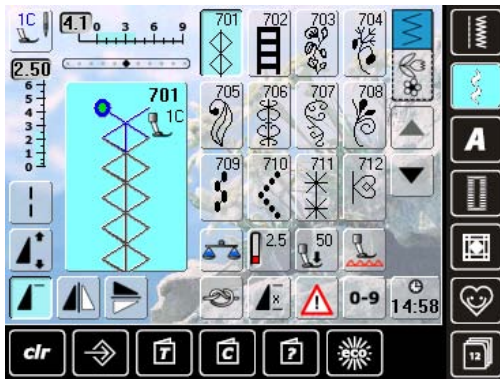

Novelty Stitches

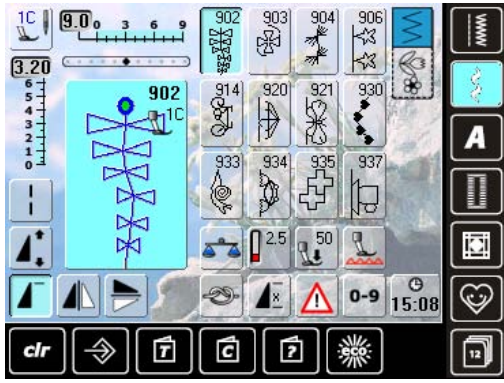

Tassels

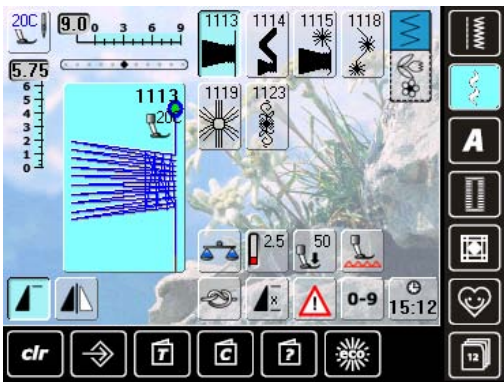

Quilt Stitches

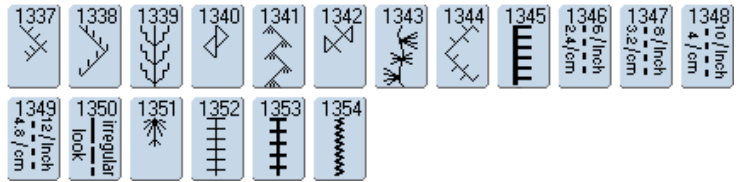

Tapering Stitches



Alphabets

Block

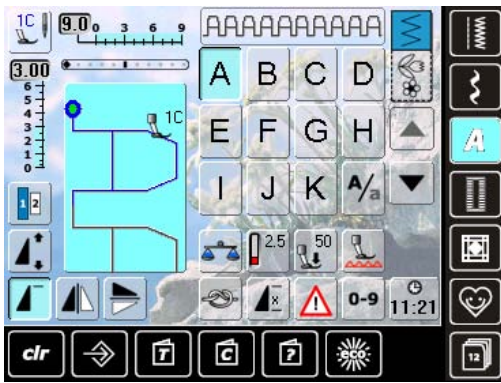

L	M	N	O	P	Q	R	S	T	U	V	W
X	Y	Z	Ä	À	Â	Å	Æ	Ç	È	É	Ê
Ñ	Ö	Ø	Ü	1	2	3	4	5	6	7	
8	9	0	-	-	.	'	!	+	=	&	÷
?	%	@	()	[]					

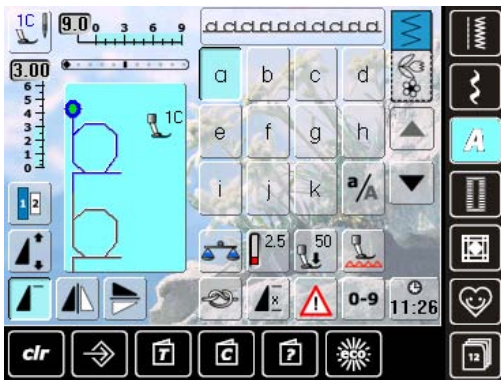

l	m	n	o	p	q	r	s	t	u	v	w
x	y	z	ä	à	â	å	æ	ç	è	é	ê
ñ	ö	ø	ü								

Double Block

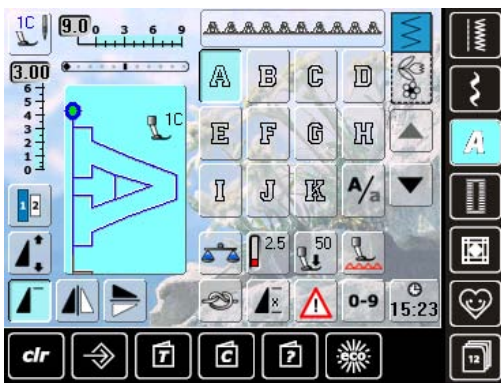

L	M	N	O	P	Q	R	S	T	U	V	W
X	Y	Z	Ä	À	Â	Å	Æ	Ç	È	É	Ê
Ñ	Ö	Ø	Ü	1	2	3	4	5	6	7	
8	9	0	-	-	.	'	!	+	=	&	÷
?	%	@	()	[]					



l	m	n	o	p	q	r	s	t	u	v	w
x	y	z	ä	à	â	å	æ	ç	è	é	ê
ñ	ö	ø	ü								

Script

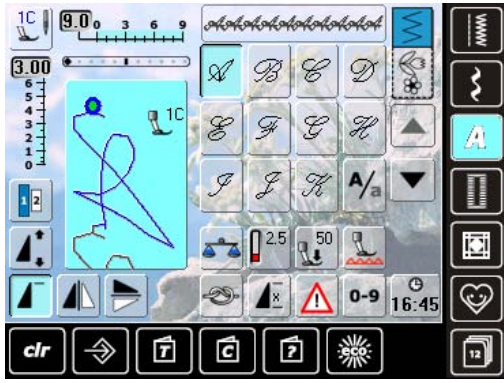

L	M	N	O	P	Q	R	S	T	U	V	W
X	Y	Z	À	Á	Â	Ë	Ç	È	É	Ê	Ë
Ñ	Ë	Ë	Ë	Ë	1	2	3	4	5	6	7
8	9	0	-	-	.	'	!	+	=	&	÷
?	%	@	()	[]					



l	m	n	o	p	q	r	s	t	u	v	w			
x	y	z	à	á	â	ã	ä	å	æ	ç	è	é	ê	ë
ñ	ë	ë	ë	ë										

Quilting Text

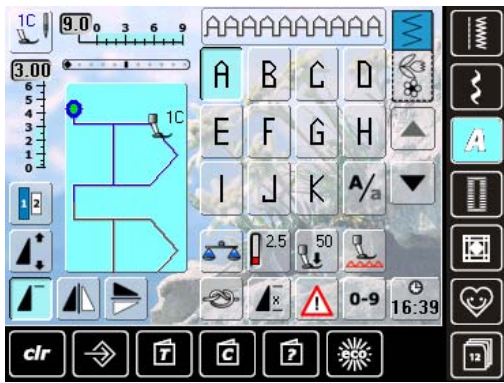

L	M	N	O	P	Q	R	S	T	U	V	W
X	Y	Z	À	Á	Â	Ë	Ç	È	É	Ê	Ë
Ñ	Ë	Ë	Ë	Ë	1	2	3	4	5	6	7
8	9	0	-	-	x	¡	↓	+	=	&	÷
?	%	@	()	[]					



l	m	n	o	p	q	r	s	t	u	v	w			
x	y	z	à	á	â	ã	ä	å	æ	ç	è	é	ê	ë
ñ	ë	ë	ë	ë	ú									

Kyrillic

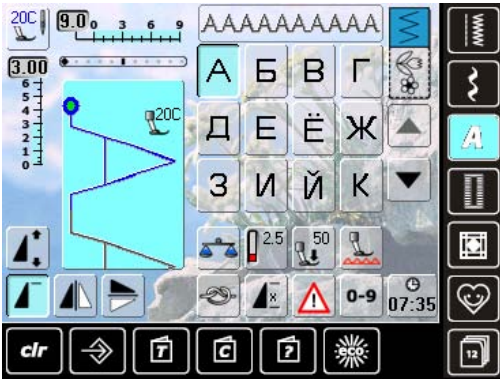

Л	М	Н	О	П	Р	С	Т	У	Ф	Х	Ц
Ч	Ш	Щ	Ъ	Ы	Ь	Э	Ю	Я			

Hiragana

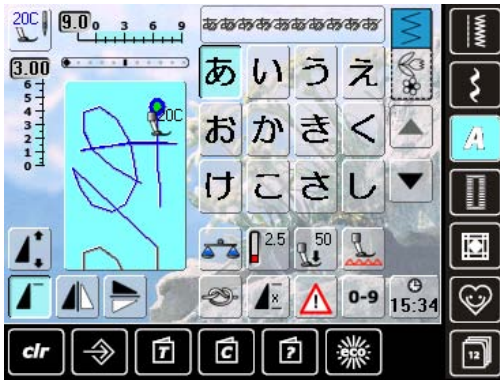

す	せ	そ	た	ち	つ	て	と	な	に	ぬ	ね
の	は	ひ	ふ	へ	ほ	ま	み	む	め	も	や
ゆ	よ	ら	り	る	れ	ろ	わ	を	ん	あい	
う	え	お	や	ゆ	よ	つ	が	ぎ	く	げ	こ
ざ	じ	ず	ぜ	ぞ	だ	ち	づ	で	ど	ば	び
ぶ	べ	ぼ	ば	び	び	ぺ	ぽ	1	2	3	4
5	6	7	8	9	0	-	_	.	?	!	.
、	「	」	『	』							

Katakana



ス	セ	ソ	タ	チ	ツ	テ	ト	ナ	ニ	ヌ	ネ
ノ	ハ	ヒ	フ	ヘ	ホ	マ	ミ	ム	メ	モ	ヤ
ユ	ヨ	ラ	リ	ル	レ	ロ	ワ	ヲ	ン	ァ	ィ
ゥ	ェ	ォ	ャ	ュ	ョ	ッ	ガ	ギ	グ	ゲ	ゴ
ザ	ジ	ズ	ゼ	ゾ	ダ	ヂ	ヅ	デ	ド	バ	ビ
ブ	ベ	ボ	パ	ピ	プ	ペ	ポ	1	2	3	4
5	6	7	8	9	0	-	_	.	?	!	·
,	「	」	『	』							

Kanji

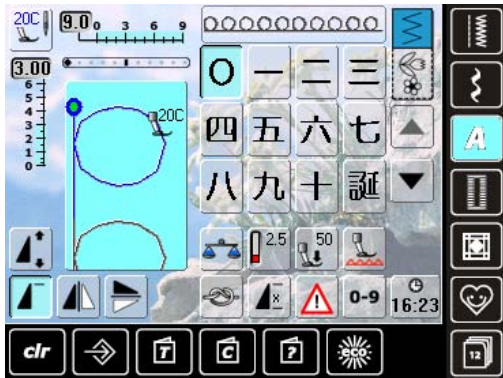

生	日	年	才	組	保	育	幼	稚	園	小	中
学	校	月	火	水	木	金	土				

A

Accessories	
Accessory box	8, 9
Sewing	6
Adjusting the Stitch Length/ Width	31, 57
Alphabets/Characters	32
Changing the size of lettering	34, 67
Combined with functions	66, 67
Combining	66
In long-term memory	81
Selecting	56, 65
Appliqué	90
Arrow Icon/Scroll Up	33
Automatic Buttonhole	99-102
Foot with slide 3A	7
Programming	34, 72
Automatic Functions	
Cutting the threads	11, 30, 39
Darning	95
Needle stop	10, 30
Pattern end	10, 30
Raise presser foot	10, 39
Securing	10, 39
Securing stitch program	31, 38
Security program	35, 63
Stitch width limitation	63
Threading the needle	10, 11, 18, 19
Threading the upper thread	18, 19, 30
Automatic Threading	
Upper thread	18, 19, 30

B

Backstepping	30, 35, 57, 83
Balance	51
BERNINA Dual Feed	52
Buttonholes	70
Decorative stitches	51
Basting	88
Battery	12, 117
BERNINA Dual Feed	113

Blind Stitch

Practical stitch	58, 97
Presser foot	7
Quilting	76

Bobbin

Bobbin	14
Bobbins in the accessory box	9
Removing/inserting the bobbin	16
Winding	15
Bobbin-Play sewing	104
Bobbin winding device	10

BERNINA Stitch Regulator (BSR)

Acoustic Signal	111
Activating/Deactivating	108, 112
Presser foot	7, 109
Free-Motion quilting	110
Functions	110
Mode	108
Preparation	109
Sewing	108, 112

Button Sew-on Program

68, 74, 75

Buttonhole

32, 68, 99

5-steps	69
7-steps	69
Automatic	71, 99
Balance	70
Buttonhole slit	34, 69
Buttonhole type	68
Cutting open	102
Entering/programming the length	71
Important Information	99
In Long-Term Memory	74
Manual	69, 99
Measuring of button size	71
Presser feet	7
Programming	69, 72
Stabilizer	100

C

Carrying Handle	10
Change	
Letter size in alphabets	67
Programmed buttonhole	74
Sewing speed	13, 31, 38
Stitch patterns	78
Stitch width and length	57
Thread tension	25, 35
Welcome screen	37

Cleaning	46, 116	F	
Combi Mode	33, 35, 107	Fabric	
Combining		BERNINA Dual Feed	114
Alphabets	66	Feed	23
Correcting	84	Needle and thread	26, 27
Deleting	85	Fabric Feed	23
Practical-/Decorative stitches	64	Feed-dog	23
Repeat 1-9x	34	Position	34
Saving	35, 81	Raising/lowering the feed-dog	12, 33
Securing program	31, 34	Foot Control	
Subdivider 1	35, 85	Connection	12
Subdivider 2	35, 85	Needle stop up/down	13, 30
Contents		Start/Stop function	30
Sewing	3	Foot Control – Additional Functions	
Cover		Needle up/down	13
Battery	117	Free Hand System (FHS)	12
Head cover	120, 132	H	
Creative Consultant	49	Handwheel	10
D		Help	32, 50
Darning	59, 94, 95	Hem	96
Decorative Stitch Patterns	32, 60	Blind hem	58, 76, 97
Overview	136	Height Compensation Tool	24
Deleting		History	32, 80
clr	32	I/J	
Combinations	82, 85	Information	36, 40
Stitches	35, 66, 79	Inserting a Bobbin	16
User Data	44	L	
Details		Languages	40
Accessories	6	Leave active screen	
Sewing computer	10	ESC	34
Display	32	LED Sewing Light	13
Calibrating	42	Lettering Size	34
ECO Mode	32, 53	Long Stitch	34
Overview	32	Function	62
Wallpaper	37	Long Term Memory	81
Welcome Text	37	Modifications	84
Double and Triple Needles		Opening	83
For decorative sewing	63	Stitch combinations	81
Security program	35, 63	Lubricating	116, 122
Threading double and triple needles	19		
E			
ECO	53		
Error Messages	118-134		
External Function Buttons	10, 30, 31		

M		Personal Program	32, 77-79
Main Power Switch	12	Power Cable	6
		Connection	10, 12
Maintenance and Troubleshooting	115-134	Practical Stitches	32
Cleaning	116	Adjusting individual	57
Maintenance	116, 117	Brief Description	58
Troubleshooting	118-134	In Personal Program	77
		Overview	136
Manual Threading		Preparing and Setting Up	
Double and triple needles	19	The sewing computer	12-25
Lower thread	16		
Upper thread	18	Presser Foot	
Messages	118-134	BERNINA Specialty feet	7
		BSR foot	108, 109
Mirror-Image Function		Changing the presser foot	22
Combined with functions	62	Display	35
Left/Right	34	Position of presser foot	10, 31
Mirroring of entire combinations	83, 84	Presser feet summary	7
Up/Down	34	Presser foot pressure	33, 35, 52
		Raise/lower the presser foot	12, 39
Multifunction Knobs	10, 31	Pre-tension	10, 15, 19
Multifunction Tool	6, 22		
N		Q	
Needle		Quilting	90, 107
Altering the needle position	31, 57	Free-Motion quilting	107
Automatic threading	10, 18, 30	Labels	107
Changing the needle	22	Stitches	76, 91
Double and triple needles	19	With BSR	108
In standard accessories	6		
Information	40	R	
Needle stop up/down	10, 30, 39	Reset	36, 44
Needle summary	28		
Needle/thread combination	26, 27	Reverse Sewing	30, 35, 57, 83
Position button	10, 31	Button	30, 57
Security program	35, 63	Permanent reverse sewing	35
Up/Down with Foot control	13	Running Stitch	58
Needle Clamp	10	S	
O		Safety Instructions	2
Optional Accessories		Satin Stitch	76
Sewing	7	Saving	
Overlock		Function button	35
Seams	96, 97	Saving stitch pattern combinations	81
Stitches	58, 59	Stitch Altering Area	33, 79
Overwriting	85	The special screen	79
P		Seam Guide	17
Patchwork	90	Select	
Specialty feet	7	Alphabets	65
Stitches	76	Buttonholes	68
With BERNINA Dual Feed	114	Menu	36
Permanent Reverse Sewing	35, 79	Practical stitches	58
		Presser Foot	56
		Quilting stitches	76
		Stitch patterns	32, 56

Service Data	41	Spool Disc	6
Servicing	116, 117	Spool Holder	14
Settings		Start/Stop Button	30
Acoustic Signal	43, 111	Stitch Altering Area	33, 78
Confirming	34	Stitch Counter Function	34, 69
Customizing the screen	37	Stitch Width/Length Knob	10, 31
Dealer-related data	40	Stitch Pattern	
Language	40	Buttonholes	68
Needle stop position (up/down)	30	Decorative stitches	60
Reset	44	Display	33
Screen	36	Functions	34, 35
Security Program	33	Help	50
Sewing	38	Overview	136-142
System	41	Practical stitches	58, 88
Thread tension	25	Quilt stitches	76
Update	45	Stitch Pattern Selection	
Setup Program	36-47	By number	56
Basic settings (Reset)	44	Selection	32
Cleaning	46	Stitch Plate	
Calibrating buttonhole foot no. 3A	47	Attaching/removing	23
Dealer	40	Cleaning	116
Information	40	Optional Accessories	23
Monitoring Functions	43	Stitch Category	135-142
Screen Calibration	42	Straight Stitch	58, 88
Screen Settings	37	Summary	
Sewing settings	38	Screen	32
Updating	45	Sewing computer	10, 11
Sewing	3-114	Sewing functions	34, 35
Accessories	6	Stitch patterns	136-142
Balance	51, 52	T	
Basic settings	38, 39, 44	Tapering	61, 105
Content	3	Thread	
Error messages	118	General facts	26
Function buttons	30, 31, 57	Matching fabric, thread and needle	26-28
Functions	34, 35	Threading	
Reverse sewing/Backstepping	30, 57, 83	Thread-Guide-and-Lubricating Unit	20-21
Sewing corners	24	Thread Cutter	
Sewing pattern combinations	64	Automatic	30, 39
Stitch category	135-142	For bobbin thread	16
With height compensation plates	24	For bobbin winder	10, 15, 17
Sewing Computer Cover	6	On Head Frame	11, 17
Sewing Light LED	13	Thread Guide	10
Sewing Speed	13, 31, 38	Thread-Guide-and-Lubricating Unit	20-21
Single Mode	35	Thread Tension	25
Single Pattern		Time/Alarm	33, 35
Altering a stitch combination	84		
Deleting	82		
Securing	57		
Selection by number	56		
Slide-on Table	17		
Software Version	41		
Speed Control	10, 31		

Touch Pen	6
Triple Needle	19, 28, 63
Triple Straight Stitch	58, 89
Troubleshooting	118-134
Tutorial	48

U

Updating	36, 45
Upper Thread	
Tension	25
Threading	18

USB

USB connection	10, 12
----------------	--------

W

Walking Foot	7
Wallpaper	37
Welcome Text	37
Winder	15, 17
Speed	15
Switching on/off	15
Pre-tension	10

Z

Zigzag Stitch	58, 93
With BSR	108, 112
Zipper	
Inserting a zipper	98
Zipper foot	7

