



BERNINA 435 BLACK EDITION

User Manual

Table of Contents

IMPORTANT SAFETY INSTRUCTIONS	7	2.6 Slide-on Table	31
Important Information	9	Using the Slide-on Table	31
1 My BERNINA	11	2.7 Presser Foot	32
1.1 Introduction	11	Adjusting the Presser Foot Position via the Knee Lifter of the Free Hand System (optional accessory)	32
1.2 BERNINA Quality Control	11	Changing the Presser Foot Sole	32
1.3 Welcome to the World of BERNINA	11	Changing the Presser Foot	33
1.4 Overview Machine	13	Having the Presser Foot displayed in the User Interface	33
Overview Front Controls	13	Adjusting the Presser Foot Pressure	34
Overview Front	14	2.8 Needle and Stitch Plate	34
Overview Sideways	15	Changing the Needle	34
Overview Back	16	Selecting the Needle in the User Interface	35
1.5 Supplied Accessories	16	Remembering Needle Type and Needle Size	35
Overview Accessories Machine	17	Adjusting the Needle Position Up/Down	35
Overview Presser Feet	18	Adjusting the Needle Position Left/Right	35
1.6 Overview User Interface	20	Needle Stop Up/Down (Permanent)	36
Overview Functions/Visual Information	20	Changing the Stitch Plate	36
Overview System Settings	20	Selecting the Stitch Plate in the User Interface	37
Overview Selection Menu Sewing	21	2.9 Threading	37
Software Operation	21	Threading the Upper Thread	37
1.7 Needle, Thread, Fabric	23	Threading the Twin Needle	39
Overview Needles	23	Threading the Triple Needle	40
Example for Needle Description	26	Winding the Bobbin Thread	40
Thread Selection	26	Threading the Bobbin Thread	41
Needle/Thread Combination	27	Instruction how to Thread the Bobbin Thread	43
2 Sewing Preparation	28	3 Setup Program	44
2.1 Before Using the Machine for the First Time	28	3.1 Sewing Settings	44
2.2 Connection and Switching On	28	Adjusting the Upper Thread Tension	44
Connecting the Foot Control	28	Adjusting the Maximum Sewing Speed	44
Connecting the Machine	28	3.2 Selecting Personal Settings	44
Attaching the Knee Lifter of the Free Hand System (optional accessory)	29	3.3 Activating the Audio Signals	45
Attaching the Touchscreen Pen (optional accessory)	29	3.4 Machine Settings	45
Switching the Machine On	29	Selecting a Language	45
2.3 Foot Control	29	Adjusting the Screen Brightness	45
Regulating the Speed via the Foot Control	29	Reviewing the Total Number of Stitches	46
2.4 Spool Pin	30	Entering the Data of the Specialized Dealer	46
Retractable Spool Pin	30	Saving Service Data	46
Horizontal Spool Pin	31	Back to Default Setting	47
2.5 Feed Dog	31	Deleting User Data	47
Adjusting the Feed Dog	31	Calibrating the Buttonhole Foot #3A	47
Adjusting the Feed Dog	31	4 System Settings	49
		4.1 Calling up the Tutorial	49
		4.2 Calling Up the Creative Consultant	49



4.3	Using eco Mode	49	6.6	Sewing Triple Straight Stitch	64
4.4	Calling Up the Help	49	6.7	Sewing Triple Zig Zag	64
4.5	Cancelling any Alterations with «clr»	49	6.8	Manual Darning	65
5	Creative Sewing	50	6.9	Automatic Darning	66
5.1	Overview Selection Menu Sewing	50	6.10	Reinforced Darning, Automatic	67
	Selecting a Stitch Pattern	50	6.11	Finishing Edges	68
5.2	Regulating the Speed	50	6.12	Sewing Double Overlock	68
5.3	Adjusting the Upper Thread Tension	50	6.13	Narrow Edgestitching	68
5.4	Editing Stitch Patterns	51	6.14	Wide Edgestitching	69
	Changing the Stitch Width	51	6.15	Edgestitching using the Seam Guide (optional accessory)	69
	Changing the Stitch Length	51	6.16	Sewing Hem Edges	70
	Correcting the Balance	52	6.17	Sewing Blind Hems	70
	Programming Pattern Repeat	52	6.18	Sewing visible Hems	71
	Mirror Image of Stitch Patterns	52	6.19	Sewing flat Joining Seams	71
	Quick Reverse	53	6.20	Sewing Basting Stitches	72
	Permanent Quick Reverse	53	7	Decorative Stitches	73
5.5	Combining Stitch Patterns	53	7.1	Overview Decorative Stitches	73
	Overview Combi Mode	53	7.2	Bobbin-Play	74
	Creating Stitch Pattern Combinations	53	7.3	Sewing Cross Stitches	75
	Saving a Stitch Pattern Combination	54	7.4	Pintucks	75
	Loading a Stitch Pattern Combination	54		Pintucks	75
	Overwriting a Stitch Pattern Combination	54		Overview Pintuck Feet	76
	Deleting a Stitch Pattern Combination	54		Working with Cord	76
	Editing a Single Stitch Pattern	55		Sewing Pintucks	77
	Deleting a Single Stitch Pattern	55	8	Alphabets	78
	Adding a Single Stitch Pattern	55	8.1	Overview Alphabet	78
	Mirroring a Stitch Pattern Combination	56	8.2	Creating Lettering	78
	Securing a Stitch Pattern Combination	56	9	Buttonholes	80
	Programming Pattern Repeat	56	9.1	Overview Buttonholes	80
5.6	Administering Stitch Patterns	57	9.2	Making Use of the Height Compensation Tool	81
	Saving Stitch Patterns in Personal Memory	57	9.3	Using the Compensation Plate	81
	Overwriting Stitch Patterns from the Personal Memory	57	9.4	Marking Buttonholes	81
	Loading Stitch Patterns from the Personal Memory	57	9.5	Cord	82
	Deleting Stitch Patterns from the Personal Memory	57		Using Cord with the Buttonhole Foot #3	82
5.7	Securing Stitches	57		Using Cord with the Buttonhole Foot with Slide #3A ..	83
	Securing a Seam with the Button «Securing»	57	9.6	Sewing a Test Sample	84
5.8	Height Compensation of Uneven Layers	58	9.7	Determining the Buttonhole Length with Buttonhole Foot #3	85
5.9	Sewing Corners	58	9.8	Determining the Buttonhole Length with the Buttonhole Foot with Slide #3A	85
6	Practical Stitches	59			
6.1	Overview Practical Stitches	59			
6.2	Sewing Straight Stitch	61			
6.3	Securing with the Automatic Securing Program	61			
6.4	Sewing in the Zipper	62			
6.5	Sewing both Sides of the Zipper from Bottom to Top	63			

Table of Contents

9.9 Sewing the Manual 7-step Buttonhole with the Buttonhole Foot #3 85

9.10 Sewing the Manual 5-step Buttonhole with the Buttonhole Foot #3 86

9.11 Sewing a Buttonhole automatically with the Buttonhole Foot with Slide #3A 87

9.12 Cutting the Buttonhole Open with the Seam Ripper 88

9.13 Cutting Open Buttonholes with the Buttonhole Cutter (Optional Accessory) 88

9.14 Sewing on a Button 89

9.15 Sewing Eyelets 89

10 Quilting 91

10.1 Overview Quilt Stitches 91

10.2 Quilting, Securing Program 91

10.3 Sewing Handlook Quilt Stitches 92

10.4 Guiding the Quilt Work Freely 92

11 Care and Maintenance 94

11.1 Firmware 94

Verifying the Software Version 94

Updating Firmware 94

Restoring Saved Data 95

11.2 Machine 95

Cleaning the Display 95

Cleaning the Feed Dog 95

Cleaning the Hook 96

Lubricating the hook 97

12 Errors and Faults 99

12.1 Error Messages 99

12.2 Troubleshooting 101

13 Storage and Disposal 105

13.1 Storing the Machine 105

13.2 Dispose of the Machine 105

14 Technical Data 106

15 Overview Stitch Patterns 107

15.1 Overview Stitch Patterns 107

Practical Stitches 107

Buttonholes 107

Decorative Stitches 107

Quilt Stitches 108

Index 109




Appropriate Use

- The machine may be used, cleaned and maintained by children older than eight or by people with reduced physical, sensory or mental capabilities or if there is a lack of experience and knowledge as long as they have been given instructions.
- Furthermore, these persons must be supervised while working with the machine, and/or they must know the safe operation of the machine and be aware of the resulting hazards.
- Children are not allowed to play with the system.
- Special care should be taken when the machine is operated by or in the presence of children.
- Only use the machine with the supplied power cable.
- USA and Canada only: Do not connect power plug NEMA 1-15 to circuits exceeding 150 volt-to-ground.
- Only use this machine with the supplied foot control of type SR-1.
- Do not insert any objects into the openings of the machine.
- Do not place any objects on the foot control.
- While sewing, guide the fabric gently. Pulling and pushing the fabric can cause needle breakage.
- Keep fingers away from all moving parts.
- Special care is required in the needle area.
- For activities in the needle area - such as threading the needle, changing the needle, threading the looper or changing the presser foot - switch off the machine.
- To switch off, set the power switch to «0».
- When protective covers are removed, when the machine is oiled or when other cleaning and maintenance operations mentioned in this instruction manual are

carried out, switch off the machine and disconnect the power plug from the outlet.

- Pull the plug out of the outlet by pulling on the plug. Do not pull on the cable.

Safety Signs on the Machine

Sign	Purpose
	<p>Caution; moving parts.</p> <p>To reduce the risk of injury, switch off the machine before maintenance work.</p>



Important Information

Availability of the Instruction Manual

The instruction manual is supplied with the machine.



- Keep the instruction manual safe at a suitable place near the machine to have it at hand in case that you need to look up something.
- If you pass the machine to a third party, always include the instruction manual.
- The latest version of the instruction manual can be downloaded at www.bernina.com

Proper Use

Your BERNINA machine is conceived and designed for private household use. It is intended for sewing fabrics and other materials as described in this instruction manual. Any other use is not considered proper. BERNINA assumes no liability for consequences resulting from improper use.


Equipment and Scope of Delivery

Example images are used in these instructions for the purposes of illustration. The machines shown in the images and the accessories shown therefore do not always match the actual items included with your machine. The supplied accessory can vary depending on the country of delivery. You can acquire any accessories mentioned or shown that are not included in the scope of delivery as optional accessories from a specialist BERNINA dealer. Further accessories can be found at www.bernina.com.

For technical reasons and in order to improve the product, changes may be made to the equipment of the machine and the scope of delivery at any time and without prior notice.

Servicing of Double-insulated Products

In a double-insulated product two systems of insulation are provided instead of grounding. No grounding means is provided on a double-insulated product nor should a means for grounded be added to the product. Servicing a double-insulated product requires extreme care and knowledge of the system and should only be done by qualified service personnel. Replacement parts for a double-insulated product must be identical to the original parts in the product. A double insulated product is marked with the words: «Double-Insulation» or «double-insulated».

 The symbol may also be marked on the product.

Environmental Protection

BERNINA International AG is committed to environmental protection. We strive to minimize the environmental impact of our products by continuously improving product design and our technology of manufacturing.



The machine is labeled with the symbol of the crossed-out wastebin. This means that the machine should not be disposed of in household waste when it is no longer needed. Improper disposal can result in dangerous substances getting into the groundwater and thus into our food chain, damaging our health.

The machine must be returned free of charge to a nearby collection point for waste electrical and electronic equipment or to a collection point for the reuse of the machine. Information on the collection points can be obtained from your local administration. When purchasing a new machine, the dealer is obliged to take back the old machine free of charge and dispose of it properly.

If the machine contains personal data, you are responsible for deleting the data yourself before returning the machine.

Explanation of Symbols

 DANGER

Designates a danger with a high risk which can lead to serious injuries or even death unless it is avoided.

 WARNING

Designates a medium-risk hazard which can lead to serious injuries if not avoided.

 CAUTION

Designates a low-risk hazard which can lead to minor or moderate injuries if not avoided.

NOTICE

Designates a hazard which can lead to material damage if not avoided.



Tips from BERNINA **sewing experts** are found next to this symbol.



In our online shop you can purchase "inspiration" as an e-magazine or as a print version, either as individual issues or as a subscription. Furthermore, there are many individual downloadable cutting patterns to discover! Why not take a look at inspiration.bernina.com and follow us on Instagram ([inspiration.sewing.magazin](https://www.instagram.com/inspiration.sewing.magazin)).

BERNINA Blog



Subtle instructions, free cutting patterns and embroidery designs as well as many new ideas: All this you can find in the weekly blog of BERNINA. Our experts give useful tips and explain step by step how you can achieve the desired result. In the community you can upload your own projects and exchange experiences and ideas with other sewing and embroidering enthusiasts.

www.bernina.com/blog

Available in English, German, Dutch and French.

BERNINA Social Media



Follow on social networks to learn more about events, thrilling projects as well as tips and tricks all about sewing, quilting and embroidering. We will keep you informed and we are looking forward to presenting you the one or the other highlight from the world of BERNINA.

www.bernina.com/social-media

BERNINA World App



Download the BERNINA App from the App Store to your smartphone and enjoy direct access to all product information. The accessory organizer gives you an overview of your accessories and those you still would like to have. Furthermore, you have direct access to the customer portal, the blog and the "inspiration" online store, and you can always find an authorized specialist dealer near you. The app is available in the Apple App Store and the Google Play Store. You will find direct links at: www.bernina.com/app



1.4 Overview Machine

Overview Front Controls



- | | | | |
|---|----------------|---|--------------------------|
| 1 | Quick reverse | 6 | Presser foot pressure |
| 2 | Securing | 7 | Upper Multifunction knob |
| 3 | Start/Stop | 8 | Lower Multifunction knob |
| 4 | Pattern end | 9 | Needle left/right |
| 5 | Needle up/down | | |

Overview Front



- | | | | |
|---|---------------------|----|---------------------------------|
| 1 | Bobbin cover | 7 | Thread take-up lever cover |
| 2 | Presser foot | 8 | Thread take-up lever |
| 3 | Needle threader | 9 | Thread cutter |
| 4 | Sewing light | 10 | Needle fixing screw |
| 5 | Thread cutter | 11 | Connection for slide-on table |
| 6 | Slide speed control | 12 | Connection for Free Hand System |

Overview Back



- | | | | |
|---|-------------------------------|----|--------------------------|
| 1 | Air Vents | 9 | Bobbin Winding Unit |
| 2 | Connection for Slide-on Table | 10 | Bobbin Winder Pretension |
| 3 | Connection for Darning Hoop | 11 | Thread Take-up Lever |
| 4 | Presser Foot Lifter | 12 | Thread Guide |
| 5 | Carrying Handle | 13 | Thread Cutter |
| 6 | Spool Pin | 14 | Feed Dog |
| 7 | Thread Guide Eye | 15 | Stitch Plate |
| 8 | Retractable Spool Pin | | |

1.5 Supplied Accessories



You will find further information and application tips on the supplied and optional accessories at:
www.bernina.com/435#!accessories

Overview Accessories Machine
















Illustration	Name	Purpose
	Dust Cover	To protect the machine from dust and contamination.
	Accessory Bag	To store the supplied accessories as well as the optional accessories.
	Free Hand System (FHS)	To raise and lower the presser foot.
	Slide-on Table	To increase the sewing surface.
	Spool Cap	To support the regular unwinding of the thread from the spool.
	Bobbin for B9 Hook Set of 4	To wind the bobbin thread.
	Foam Pad 1 piece	The foam pad prevents the thread from slipping, tangling or breaking on the spool pin.
	Seam Ripper	To undo seams and to cut buttonholes open.
	Height Compensating Tool	To level an angled position of the presser foot sole when sliding over thick seams.
	Needle Assortment	For any common applications.

Illustration	Name	Purpose
	Screwdriver red (slot)	To loosen and tighten slotted screws.
	Brush	To clean the feed dog and the looper area.
	Sewing Machine Oil	To oil the machine.
	Power Cable	To connect the machine with the power supply system.
	Foot Control	To start and stop the machine. To control the sewing speed.

Overview Presser Feet

NOTICE! Depending on the country of delivery, the machine is delivered either with snap-on presser feet or with standard presser feet. The respective standard accessories are listed in the following two charts. When snap-on feet are supplied as standard accessories, there is no claim to get the standard presser feet free of charge. But they can be ordered as optional accessories.

Supplied snap-on presser feet





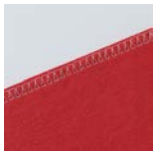





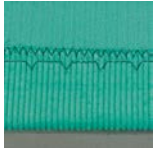


Illustration	Number	Name	Purpose	Example
	#78	Snap-On Shank	For securing the interchangeable snap-on soles.	
	#1	Reverse Pattern Sole	For sewing different practical and decorative stitches. To sew forward and in reverse.	
	#2	Overlock Sole	To finish edges in stretch material.	

Illustration	Number	Name	Purpose	Example
	#3	Buttonhole Sole	To sew buttonholes.	
	#4	Zipper Sole	For sewing in zippers.	
	#5	Blindstitch Sole	For sewing blind-stitch hems.	
	#20	Open Embroidery Sole	For sewing applications and decorative patterns.	

Supplied Standard Presser Feet


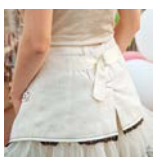





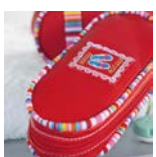

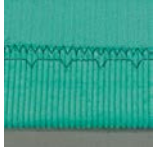
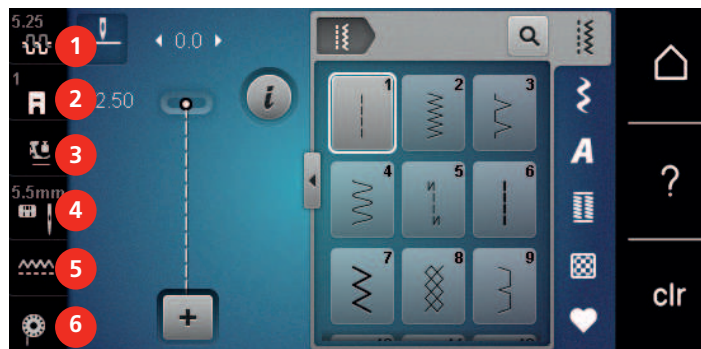
Illustration	Number	Name	Purpose	Example
	#1	Reverse Pattern Foot	For sewing different practical and decorative stitches. To sew forward and in reverse.	
	#2	Overlock Foot	For overlock seams. For overcasting seams. For visible seams on stretch fabrics.	
	#3A	Buttonhole Foot with Slide	To sew buttonholes automatically.	
	#4	Zipper Foot	For sewing in zippers.	

Illustration	Number	Name	Purpose	Example
	#5	Blindstitch Foot	For sewing blind-stitch hems. For stitching edges guided on the left side of the presser foot.	

1.6 Overview User Interface

Overview Functions/Visual Information



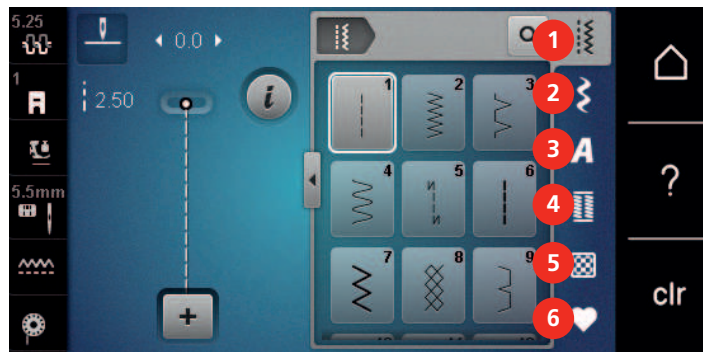
- | | | | |
|---|---|---|---------------------------------|
| 1 | «Upper Thread Tension» | 4 | «Stitch Plate/Needle Selection» |
| 2 | «Presser Foot Indicator/Presser Foot Selection» | 5 | «Feed Dog Indicator» |
| 3 | «Presser Foot Pressure» | 6 | «Bobbin Thread» |

Overview System Settings



- | | | | |
|---|-----------------------|---|------------------|
| 1 | «Sewing Mode» | 5 | «eco Mode» |
| 2 | «Setup Program» | 6 | «Home» |
| 3 | «Tutorial» | 7 | «Help» |
| 4 | «Creative Consultant» | 8 | «Clear Settings» |

Overview Selection Menu Sewing



- | | | | |
|---|-----------------------|---|-------------------|
| 1 | «Practical Stitches» | 4 | «Buttonholes» |
| 2 | «Decorative Stitches» | 5 | «Quilt Stitches» |
| 3 | «Alphabets» | 6 | «Personal Memory» |

Software Operation

The touch-sensitive display can be operated with the finger or touchpen.

Tap: Short tap of an element.

Swipe: Tap an element and swipe quickly on the display.



Draw: Tap the display and slowly move in one direction, eg. for scrolling up and down.

Navigation


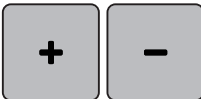

Illustration	Name	Purpose
	«Home»	Show Home screen.
	Navigation Path	Show a previous menu level.
	«Close»	Close the window.
	More	Show more features or information.
	Continue	Scroll to next display.
	Back	Scroll to previous display.

Activate/Deactivate Functions

Illustration	Element	Status
	Switch	Function is activated.
		Function is deactivated.

Illustration	Element	Status
	Icon	Function is deactivated.
		Function is activated.

Adjust Values

Illustration	Name	Purpose
	Slider Control	Set the value with the slider control. Reset the value to the default value by tapping the small bullet.
	Field «Plus» / «Minus»	«Plus» increase, «Minus» reduce the value.
	Yellow Frame	Indication that the set value differs from the default value. Reset the value to the default value by tapping.

Enter Text and Numbers

To enter numerical values or text, a corresponding keyboard is shown.











Illustration	Name	Purpose
	Entry Field	Display of the entry. Delete all characters entered with a single tap.
	«Deleting»	Delete the last character.
	«Lower Case Characters»	Show the available letters in lower case letters.
	«Upper Case Characters»	Show the available letters in upper case letters.

Illustration	Name	Purpose
	«Numbers and Mathematical Characters»	Show the available numbers and mathematical characters.
	«Special Characters»	Show the available special characters.
	«Confirm»	Confirm the entry and leave the submenu.
	«Cancel»	Cancel the entry and the view closes.

1.7 Needle, Thread, Fabric

Needles will wear down over time. Therefore, the needle should be replaced regularly. Only a perfect point results in a good stitching result. In general, the thinner the fabric, the finer the needle. The illustrated needles are either standard or optional accessory, depending on the machine.

- Needle sizes 70, 75: for light-weight fabrics.
- Needle sizes 80, 90: for medium fabrics.
- Needle sizes 100, 110 and 120: for heavy fabrics.

Overview Needles

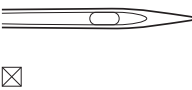
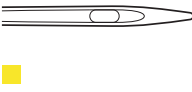
Illustration	Needle Name	Needle Description	Purpose
	Universal Needle 130/705 H 60/8 – 120/19	With a slightly rounded point.	For woven fabrics (light, medium, heavy-weight), knitwear, leather, plastic, jeans/denim. For natural and synthetic fabrics. For general sewing, sewing on buttons and buttonholes, zippers, hems and topstitching, decorative sewing, embroidery, patchwork, quilting.
	Stretch Needle 130/705 H-S 75/11 – 90/14	With a medium ball point.	For knitwear (jersey, tricot, knit and stretch material). For general sewing, sewing on buttons and buttonholes, zippers, hems and topstitching, decorative sewing, embroidery.

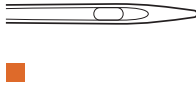




Illustration	Needle Name	Needle Description	Purpose
	Jersey/Embroidery Needle 130/705 H SUK 80/12	With a medium ball point.	For woven fabrics (light, medium, heavy-weight), knitwear, plastic. For general sewing, sewing on buttons and buttonholes, zippers, hems and topstitching, decorative sewing, embroidery.
	Jeans Needle 130/705 H-J 80/12 – 110/18	With slim, particularly acute point.	Woven fabrics (light, medium, heavy-weight), leather, jeans/denim. For general sewing, sewing on buttons and buttonholes, zippers, hems and topstitching, decorative sewing, embroidery, patchwork, quilting.
	Leather Needle 130/705 H LR 90/14, 100/16	With a cutting point (LR = special point to sew leather).	For leather, imitation leather and other similar materials. For zippers, hems and topstitching, materials that tend to stick.
	Microtex Needle 130/705 H-M 60/8 – 110/18	With a particularly pointed and slender tip.	For woven fabrics (light, medium, heavy), artificial materials and materials that are difficult to work with. For silk, microfibre fabrics, foils, coated and hard-sliding materials. For sewing in general, sewing on buttons and buttonholes, zips, hems and topstitching and decorative sewing. For ultra straight stitches when topstitching edges.
	Quilting Needle 130/705 H-Q 75/11 – 90/14	With a very slim, slightly rounded point.	For woven fabrics (light, medium and heavy-weight). Decorative sewing, patchwork, quilting. For stitching/topstitching tasks, such as quilting and patchwork.

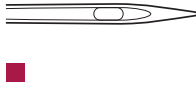
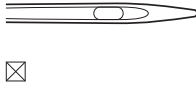
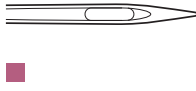
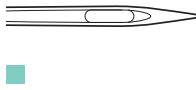
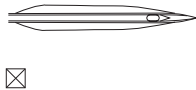
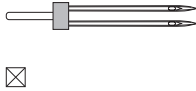



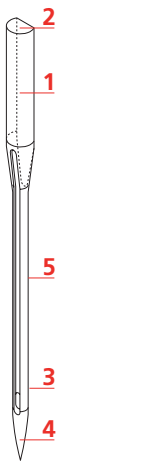
Illustration	Needle Name	Needle Description	Purpose
	Embroidery Needle 130/705 H-E 75/11 – 90/14	With a light ball point and a particularly wide eye and wide groove.	For woven fabrics (light, medium, heavy-weight), knitwear. For voluminous and woolen threads. For general sewing, sewing on buttons and buttonholes, zippers, hems and topstitching, decorative sewing, embroidery.
	Fine Fabrics Needle 130/705 H SES 70/10 – 90/14	With a light ball point.	For fine, delicate materials, such as velvet. For general sewing, sewing on buttons and buttonholes, zippers, hems and topstitching, decorative sewing, embroidery, patchwork, quilting.
	Metafil Needle 130/705 H METAFIL 80/12	With medium ball point and long eye (2 mm).	For woven fabrics (light, medium, heavy-weight), knitwear. For sewing with special effects and fancy threads, especially metallic threads. For embroidery with metallic thread. For hems and topstitching, decorative sewing and embroidery.
	Topstitch Needle 130/705 H-N 80/12 – 100/16	With medium ball point and long eye (2 mm).	For woven fabrics (light, medium and heavy-weight). For hems and topstitching, decorative sewing and embroidery. For decorative and quilting work with several sewing threads and also for embroidery.
	Hemstitch Needle 130/705 H WING 100/16, 120/20	With a «wing» on each side of the needle blade.	For woven fabrics (light, medium and heavy-weight). For special effects with hemstitch embroidery.
	Universal Twin Needle 130/705 H ZWI 70-100	Needle distance: 1.0/1.6/2.0/2.5/3.0/4.0/ 6.0/8.0	For visible hems in stretch fabrics, pintucks, decorative sewing.

Illustration	Needle Name	Needle Description	Purpose
 ☒	Stretch Twin Needle 130/705 H-S ZWI 75	Needle distance: 2.5/4.0	For visible hems in stretch fabrics, pintucks, decorative sewing.
 ☒	Hemstitch Twin Needle 130/705 H ZWIHO 100	Needle distance: 2.5	For special effects with hemstitch embroidery.
 ☒	Universal Triple Needle 130/705 H DRI 80	Needle distance: 3.0	For visible hems in stretch fabrics, decorative sewing.

Example for Needle Description

The 130/705 system, which is the most common for household machines, is explained by the following picture of a Jersey/Stretch needle.

	<p>130/705 H-S/70</p> <p>130 = Shank length (1)</p> <p>705 = Flat shank (2)</p> <p>H = Needle scarf (3)</p> <p>S = Needle point (here medium ball point) (4)</p> <p>70 = Needle size 0.7 mm (5)</p>
---	---

Thread Selection

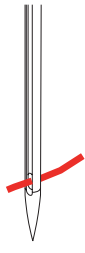
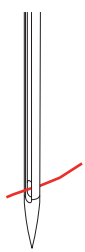
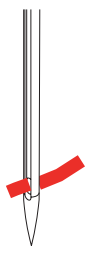
For a perfect sewing result, thread and fabric quality play an important role.

We recommend purchasing quality threads to achieve good sewing results.

- Cotton threads have the advantage of being a natural fiber and therefore are especially suitable for sewing cotton fabrics.
- Mercerized cotton threads have a slight sheen that is not lost with washing.
- Polyester threads have a high tensile strength and is particularly colorfast.
- Polyester threads are more flexible and are recommended where a strong and elastic seam is required.
- Rayon threads are made of natural fibers and have a brilliant sheen.
- Rayon threads are suitable for decorative stitches and achieve a more beautiful effect.



Needle/Thread Combination

	<p>The needle/thread combination is correct, when the thread fits perfectly into the long groove and goes easily through the needle eye. The thread can be optimally sewn.</p>
	<p>The thread can break and skipped stitches can occur when there is too much clearance in the long groove and the needle eye.</p>
	<p>The thread can break and get stuck when the thread scrapes against the edge of the long groove not fit well into the needle eye optimally.</p>

2 Sewing Preparation

2.1 Before Using the Machine for the First Time



BERNINA recommends lubricating the hook before using the machine for the first time or after a longer period of non-use. (see page 97)

By oiling the hook, the occurrence of unwanted noises in the hook area can be avoided.

2.2 Connection and Switching On

Connecting the Foot Control

- > Roll out the connection cable on the underside of the foot control to the desired length.



- > Plug in the plug of the connection cable on the machine.



- > Place the foot control under the table.

Connecting the Machine

To ensure safe operation of the machine, only the supplied mains cable may be used. The supplied power cable is designed for the voltage range applicable in the country of use. If the machine is to be used in a country other than the country of origin, the power cable suitable for that country must be obtained from the authorized BERNINA dealer.

The power cable for the USA and Canada has a polarized power plug (one contact is wider than the other). To reduce the risk of an electric shock, the plug can only be inserted into the socket in one way. If the power plug does not fit in the socket, reverse then insert the power plug. If the reversed power plug still does not fit, an electrician must install an appropriate socket. Do not modify the power plug in any way.

- > Insert the device connector of the power cable into the machine's power cable connection.



- > Insert the power plug of the power cable into the socket.

Attaching the Knee Lifter of the Free Hand System (optional accessory)



The lateral position of the lever can be adjusted by your local BERNINA Dealer required.

- > Insert the knee lifter into the opening at the front side of the machine.
- > Adjust the sitting height so that the knee lifter can be operated with the knee.



Attaching the Touchscreen Pen (optional accessory)

- > Store the touchscreen pen at the magnet holder.



Switching the Machine On

- > Set the power switch to «I».



2.3 Foot Control

Regulating the Speed via the Foot Control

Via the foot control the speed can be adjusted infinitely variable.

- > Press the foot control down carefully to start the machine.
- > To sew faster, press the foot control harder.

- > Release the foot control to stop the machine.



2.4 Spool Pin

Retractable Spool Pin

Raise the Retractable Spool Pin



With metallic or other special threads, it is recommend to use the retractable spool pin.

The retractable spool pin is required when sewing with multiple threads, and can be used for spooling while sewing.

- > To raise the spool pin, push the spool pin down and release it.



- > To lock the spool pin, turn the spool pin anti-clockwise as far as it will go.
- > To release the lock, turn the spool pin clockwise as far as it will go.
- > To lower the spool pin, push the spool pin down until it clicks into place.

Inserting Foam Pad and Thread Spool

The foam pad prevents the thread from getting hooked at the spool pin.

- > Place the foam pad on the spool pin.
- > Place the thread spool on the foam pad.



Horizontal Spool Pin

Placing the Foam Pad, the Thread Spool and the Spool Cap

Spool caps hold the thread spool in place for proper release of thread from the spool. The spool cap is only used with the horizontal spool holder.

- > Place the foam pad on the spool pin.
- > Place the thread spool on the spool pin.
- > Position the appropriate spool cap on the spool pin so that there is no space between the spool cap and the thread spool.



Using the Spool Net (Optional Accessories)

The spool net holds the thread on the thread spool and prevents the thread from knotting and breaking.

- > Pull the spool net over the thread spool. Ensure when doing so that the spool net does not slip off the thread spool, e.g. double-insert the net over the thread spools or insert a part of the net into the thread spool at the rear.



2.5 Feed Dog

Adjusting the Feed Dog

- > To lower the feed dog, push the button «Feed Dog Up/Down».



- > To raise the feed dog, push the button «Feed Dog Up/Down» again.

Adjusting the Feed Dog



- > Tap «Feed Dog Indicator».
- > Raise or lower the feed dog according to the animation.

2.6 Slide-on Table

Using the Slide-on Table

The Slide-on Freearm Extension Table, attached to the freearm, enables the available sewing area to be extended.



- > When a presser foot is tapped, the description and use for that presser foot appears.



Adjusting the Presser Foot Pressure

The pre-set standard presser foot pressure can be used for general sewing work. Reduce the presser foot pressure for tricot fabric or for loosely knitted fabrics. For firm materials, increase the presser foot pressure.



The presser foot pressure is designed to adjust the pressure of the presser foot optimally to the fabric thickness. When working with thick fabrics, it is recommended to reduce the presser foot pressure. This provides the advantage that the fabric can be moved more easily. When the presser foot pressure is set below 0, the presser foot even lifts to give more space to the thick fabric. When working with thin fabrics, it is recommended to increase the presser foot pressure. This provides the advantage that the fabric cannot be moved too easily under the presser foot.



- > Turn the knob to the right to reduce the presser foot pressure.
- > Turn the knob further to the right to raise the presser foot.
- > Turn the knob to the left to increase the presser foot pressure.

2.8 Needle and Stitch Plate

Changing the Needle

- > Switch the machine off.
- > Remove the presser foot.
- > Loosen the fixing screw for the needle by hand.



- > Pull the needle down.
- > Hold the new needle with the flat side to the back.
- > Insert the needle as far as it will go.
- > Tighten the fixing screw by hand.

Selecting the Needle in the User Interface

After changing the needle, you can check whether this can be used with the selected stitch plate.



- > Tap «Stitch Plate/Needle Selection».
- > Select the fitted needle.



Remembering Needle Type and Needle Size

Useful reminder function: So that no information is lost, the needle type and needle thickness can also be saved on the machine. This means that the saved needle type and needle thickness can be checked at any time.



- > Tap «Stitch Plate/Needle Selection».



- > Tap «Needle Selection».
- > Select the needle type () of the fitted needle.
- > Select the needle type of the fitted needle.

Adjusting the Needle Position Up/Down



- > To lower the needle, push the button «Needle position Up/Down».
- > To raise the needle, push the button «Needle position Up/Down» again.

Adjusting the Needle Position Left/Right

There is a total of 11 needle positions. The needle position is indicated by the needle position number in the display.

- > To position the needle position to the left, push the button «Needle Position Left» (1).

- > To position the needle position to the right, push the button «Needle Position Right» (2).



Needle Stop Up/Down (Permanent)



- > To set the needle stop position permanently, tap «Needle Stop Up/Down».
 - The machine stops with needle position down as soon as the foot control is released or the button «Start/Stop» has been pushed.
- > Tap «Needle Stop Up/Down» again.
 - The machine stops with needle position up as soon as the foot control is released or the button «Start/Stop» has been pushed.

Changing the Stitch Plate

The stitch plate is marked with vertical, horizontal and diagonal lines in millimeters (mm) and inches (inch). These markings are helpful for sewing or precise top-stitching.

- > Lower the feed dog.
- > Switch off the machine.
- > Remove the needle and presser foot.
- > Press the stitch plate down at the marking at the back on the right until it tilts.



- > Remove the stitch plate.
- > Place the openings of the new stitch plate above the corresponding guide pins and press down until it clicks into place.



Selecting the Stitch Plate in the User Interface

After changing the stitch plate, you can check whether it can be used with the selected needle.



- > Tap «Stitch Plate/Needle Selection».
- > Select the previously fitted stitch plate.



- If the selected stitch plate is suitable to be used in combination with the needle, sewing can begin.
- If the selected stitch plate is not suitable to be used in combination with the needle, an error message is displayed and the machine is automatically prevented from starting.

2.9 Threading

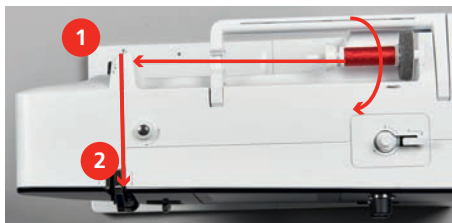
Threading the Upper Thread

Preparing for Threading

- > Place the foam pad on the spool pin.
- > Place the thread spool on the spool pin so that the thread unwinds clockwise.
- > Attach the appropriate spool cap.
- > Switch on the machine and wait until it starts up.
- > Raise the needle and presser foot.

Guiding the Thread to the Needle

- > Hold the thread with one hand between the thread spool and rear thread guide (1). Use the other hand to hold the thread at the end and, during the subsequent steps, always keep it under light tension.
- > Guide the thread in direction of the arrow through the thread tension (2).



- > Guide the thread downwards around the thread take-up lever cover (3) and then upwards.

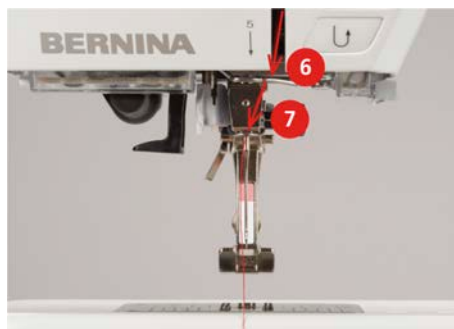
- > Insert the thread in the thread take-up lever (4).



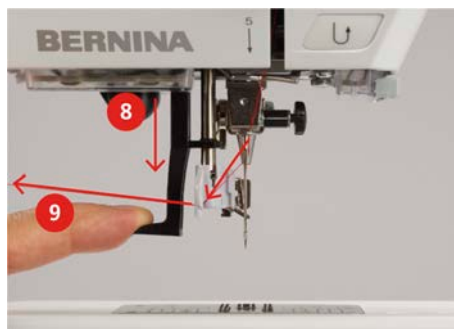
- > Guide the thread downwards again (5).
- > Only release the thread now.
- > Switch off the machine.

Threading the Needle

- > Guide the thread through the guides (6/7) above the presser foot.



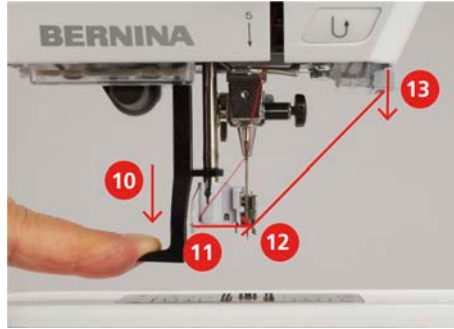
- > Push the semi-automatic needle-threading lever (8) halfway down and pull the thread behind the gray needle-threading finger/hook to the left (9).



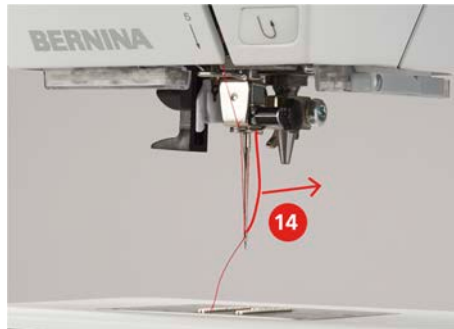
- > Guide the thread from the left to the right in front of the gray needle-threading finger/hook (11).
- > Push the needle-threading lever down as far as it will go (10).
- > Pull the thread from left to right (11) through the needle-threading slot (12) until it catches on the wire hook.



- > Pull the thread over the thread cutter (13) from the back and cut.



- > Release the threader lever and the thread at the same time to thread the needle.
 - The thread is pushed through the needle eye.
- > Pull the loop of thread (14) to the rear until the end of the thread is pulled through the needle.



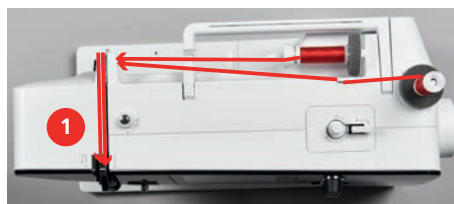
- > Pull the thread below the presser foot and through to the thread cutter (15), and cut it.



Threading the Twin Needle

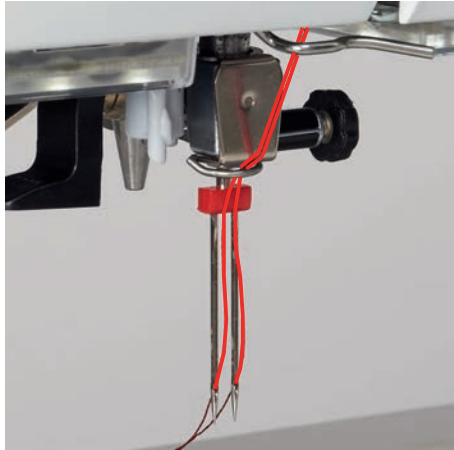
Prerequisite:

- The twin needle is inserted.
- > Guide the first thread in direction of the arrow on the right side of the tension disc (1).
- > Guide the second thread in direction of the arrow on the left side of the tension disc (1).



- > Guide the first and the second thread to the thread guide above the needle.
- > Thread the first thread manually into the right needle.

- > Thread the second thread manually into the left needle.



Threading the Triple Needle

Prerequisite:

- The triple needle is inserted.
- > Place the foam pad, the thread spool and the appropriate spool cap on the horizontal spool pin.
- > Place the foam pad on the vertical spool pin.
- > Attach the filled bobbin on the vertical spool pin so that the silvery sensor surface is down.
- > Attach the thread spool in the opposite direction to the bobbin.
- > Thread the 3 threads up to the upper thread guide.



- > Guide 2 threads (vertical spool pin) past the thread tension disc (1) on the left and up to the thread guide above the needle.
- > Guide 1 thread (horizontal spool pin) past the thread tension disc (1) on the right and up to the thread guide above the needle.
- > Thread 1 thread of the vertical thread spool pin into the left and right needle by hand.
- > Thread the thread of the horizontal spool pin into the center needle manually.

Winding the Bobbin Thread



The bobbin thread can be wound while sewing when the retractable spool pin is used for winding.

Prerequisite:

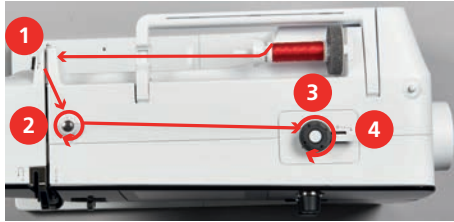
- The foam pad, the thread spool and the appropriate spool cap are fitted.
- > Attach the empty bobbin on the winding unit so that the silvery sensor surface is down.



- > Guide the thread to the left into the rear thread guide (1).



- > Guide the thread around the bobbin winder pretension clockwise (2).
- > Wind the thread clockwise 2 – 3 times around the empty bobbin (3).
- > Pull the thread over the thread cutter at the engaging lever (4) and cut.



- > Push the engaging lever (5) against the bobbin.

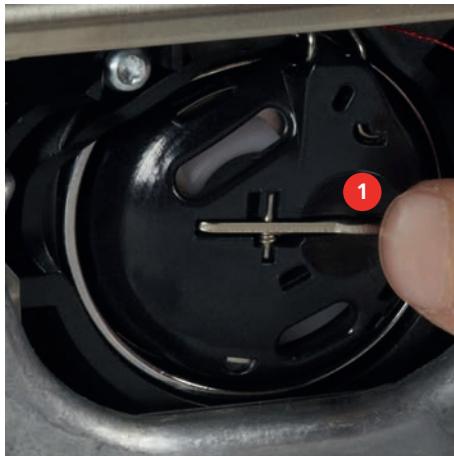


- The machine winds.
- > To stop the winding process, push the engaging lever to the right.
- > To continue the winding process, push the engaging lever against the bobbin again.
 - As soon as the bobbin is full, the machine stops the winding process automatically.
- > Remove the bobbin and cut the thread using the thread cutter at the engaging lever.

Threading the Bobbin Thread

Prerequisite:

- The needle is raised.
 - The machine is switched off and the bobbin cover is opened.
- > Press the bobbin case release at the bobbin case (1).







- > Remove the bobbin case.
- > Remove the bobbin from the bobbin case.

3 Setup Program

3.1 Sewing Settings





Adjusting the Upper Thread Tension

Changes to the upper thread tension in the Setup Program affect all of the stitch patterns. The setting in the setup is retained after the machine is switched off.

-  > Tap «Home».
-  > Tap «Setup Program».
-  > Tap «Sewing Settings».
-  > Tap «Adjusting the Upper Thread Tension».
- > Adjust the upper thread tension.




Adjusting the Maximum Sewing Speed

You can use this function to set the maximum speed.






-  > Tap «Home».
-  > Tap «Setup Program».
-  > Tap «Sewing Settings».
-  > Tap «Maximum Sewing Speed».
- > Set the maximum sewing speed.

3.2 Selecting Personal Settings



-  > Tap «Home».
-  > Tap «Setup Program».
-  > Tap «Personal Settings».
- > Select the required display color and background.
- > Tap the text box above the color settings.
- > Enter and confirm the welcome text.





3.3 Activating the Audio Signals

-  > Tap «Home».
-  > Tap «Setup Program».
-  > Tap «Setting Sound».
- > To switch off the sounds in general, tap switch (1).
- > To switch on the sounds in general, tap switch (1) again.
- > To switch on the required sound when selecting a stitch pattern, tap the corresponding «Tone» in area (2).
-  > To switch off the sound when selecting a stitch pattern, tap the corresponding «Sound Off» in area (2).
- > To switch on the required sound for selecting functions, tap the corresponding «Tone» in area (3).
-  > To switch off the sound for selecting functions, tap the corresponding «Sound On/Off» in area (3).







3.4 Machine Settings

Selecting a Language

-  > Tap «Home».
-  > Tap «Setup Program».
-  > Tap «Machine Settings».
-  > Tap «Language Selection».
- > Tap the required language.






Adjusting the Screen Brightness

The brightness of the screen can be set to meet your individual needs.

-  > Tap «Home».
-  > Tap «Setup Program».
-  > Tap «Machine Settings».
-  > Tap «Display Settings».
- > Adjusting the screen brightness.










Reviewing the Total Number of Stitches

The total number of stitches by the machine and the number of stitches since the last maintenance carried out by a specialist BERNINA dealer are displayed.

-  > Tap «Home».
-  > Tap «Setup Program».
-  > Tap «Machine Settings».
-  > Tap «Information».
-  > Tap «Firmware and hardware information».




Entering the Data of the Specialized Dealer




The contact details for your specialized BERNINA dealer can be entered.

-  > Tap «Home».
-  > Tap «Setup Program».
-  > Tap «Machine Settings».
-  > Tap «Information».
-  > To enter the data of the specialized BERNINA dealer, tap «Dealer Data».
-  > To enter the company name of the specialist BERNINA dealer, tap «Name».
-  > To enter the address of the specialized BERNINA dealer, tap «Address».
-  > To enter the telephone number of the specialized BERNINA dealer, tap «Phone Number».
-  > To enter the website or e-mail address of the specialized BERNINA dealer, tap «E-mail address».

Saving Service Data







The service data regarding the current status of the machine can be saved on a USB stick and consequently provided to the specialized BERNINA dealer.

- > Insert a USB stick which provides enough free capacity into the USB port of the machine.
-  > Tap «Home».
-  > Tap «Setup Program».
-  > Tap «Machine Settings».

-  > Tap «Information».
-  > Tap «Service Data».
-  > Tap «Export the Service Data».
 - The icon «Export the Service Data» is outlined in white.
- > If the white frame is no longer displayed, remove the USB stick.






Back to Default Setting

ATTENTION: Using this function will delete all individually made settings.

-  > Tap «Home».
-  > Tap «Setup Program».
-  > Tap «Machine Settings».
-  > Tap «Factory Setting».
-  > To restore all default settings for sewing, tap «Default Setting Sewing» and confirm.
-  > To restore all default settings, tap «Default Setting Machine», confirm and restart the machine.

Deleting User Data

Patterns which are not needed anymore can be deleted to create space for new designs.





-  > Tap «Home».
-  > Tap «Setup Program».
-  > Tap «Machine Settings».
-  > Tap «Factory Setting».
-  > To delete all data from the Personal Memory, tap «Delete Data from Own Storage Medium» and confirm.

Calibrating the Buttonhole Foot #3A

The Buttonhole Foot with Slide #3A is calibrated to the machine and they should only be used both together.

Prerequisite:

- The Buttonhole Foot with Slide #3A is fitted.
- The needle is not threaded.

-  > Tap «Home».
-  > Tap «Setup Program».
-  > Tap «Machine Settings».
-  > Tap «Maintenance/update».

Setup Program



- > Tap «Calibrating the Buttonhole Foot #3A».
- > Lower the Buttonhole Foot with Slide #3A.



- > To start the calibration, press the «Start/Stop» button.
 - When the calibration is complete, the result is shown in the display.



4 System Settings

4.1 Calling up the Tutorial

The tutorial provides information and explanations on different areas of sewing and the various stitches.



> Tap «Home».



> Tap «Tutorial».

> Select the desired topic in order to view information.

4.2 Calling Up the Creative Consultant

The Creative Consultant informs you about decision support for sewing projects. After entering the kind of fabric and the desired sewing project, suggestions concerning the suitable needle or the appropriate presser foot are displayed.



> Tap «Home».



> Tap «Creative Consultant».

> Select the fabric on which you want to sew.

> Select the sewing project.



> Tap «Confirm».

– The settings are adjusted.

4.3 Using eco Mode

If work is interrupted for an extended period, the machine can be put into energy-saving mode. The power save mode eco also serves as a child safety feature. Nothing can be selected in the display and the machine cannot be started.



> Tap «Home».



> To activate the power save mode, tap «eco Mode».

– The display goes to sleep. The power consumption is reduced and the sewing light is off.

> To deactivate the eco mode, tap the icon «eco Mode» in the center of the display.

– The machine is ready to sew.

4.4 Calling Up the Help



> Touch the window in the display where help is needed.

> To start the Help Mode, tap «Help» twice.

> Tap the icon in the display where help is needed.

4.5 Cancelling any Alterations with «clr»

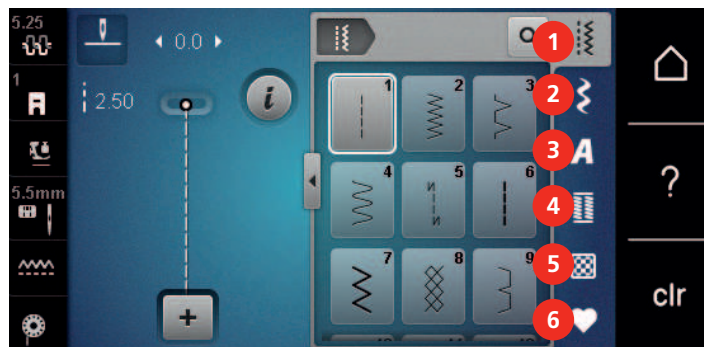
Any alterations to designs can be reset to basic setting. Exceptions are saved designs which have been filed in the personal memory and monitoring functions.



> Tap «Clear Settings».

5 Creative Sewing

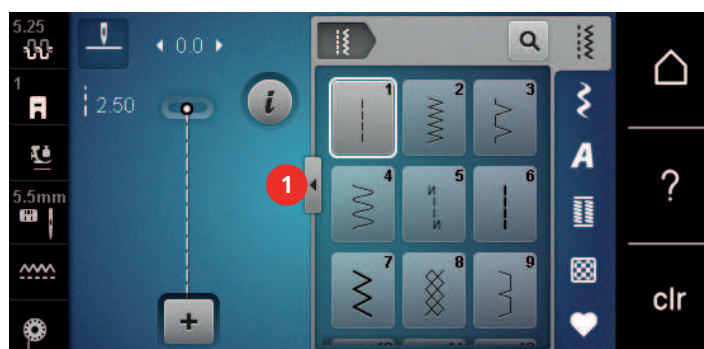
5.1 Overview Selection Menu Sewing



- | | | | |
|---|-----------------------|---|-------------------|
| 1 | «Practical Stitches» | 4 | «Buttonholes» |
| 2 | «Decorative Stitches» | 5 | «Quilt Stitches» |
| 3 | «Alphabets» | 6 | «Personal Memory» |

Selecting a Stitch Pattern

- > Select a stitch pattern, alphabet or buttonhole.
- > Wipe up in the area of the practical stitches, alphabets or buttonholes to have more stitch patterns displayed.
- > To increase the view, tap «Increasing/Decreasing the Display Size» (1).



- > To decrease the view, tap «Increasing/Decreasing the Display Size» again.
- > To select the stitch pattern via the stitch number entry, tap «Select Stitch Pattern by Number».



5.2 Regulating the Speed

The sewing speed can be adjusted infinitely variable with the slide.

- > Move the slide to the left to reduce the sewing speed.
- > Move the slide to the right to increase the sewing speed.

5.3 Adjusting the Upper Thread Tension

The basic setting of the upper thread tension is provided automatically as soon as a stitch pattern is selected.

The upper thread tension is set optimally at the BERNINA factory and the machine has been tested. Metrosene/Seralon thread size 100/2 (Mettler, Switzerland) is used for the upper and bobbin thread.

When using other sewing threads, the optimal upper thread tension may vary. It may therefore be necessary to adjust the upper thread tension individually according to the sewing project as well as the desired stitch pattern.

The higher the upper thread tension, the tighter the upper thread, and the bobbin thread is pulled up to the top of the fabric. When the upper thread tension is low, the upper thread is less tightened and the bobbin thread is pulled up less.

Alterations to the upper thread tension affect the stitch pattern that is currently selected. Permanent alteration of the upper thread tension for the sewing mode can be made in the Setup Program. (see page 44)

Prerequisite:

- The upper thread tension has been altered in the setup program.



- > Tap «Upper Thread Tension».
- > Adjust the upper thread tension.

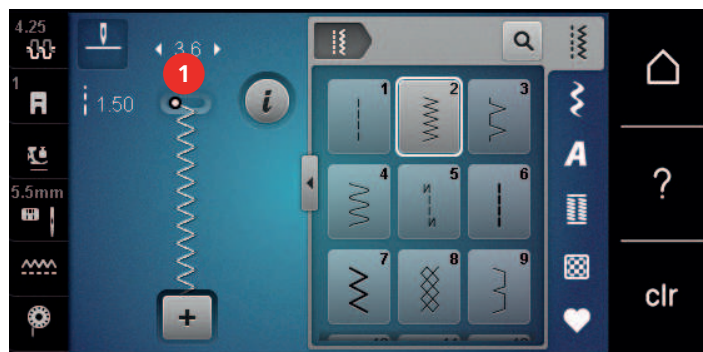


- > Tap the yellow-framed icon on the right side to reset the alterations to the default setting.
- > Tap the yellow-framed icon on the left side to reset the alterations in the «Setup Program» to the default setting.

5.4 Editing Stitch Patterns

Changing the Stitch Width

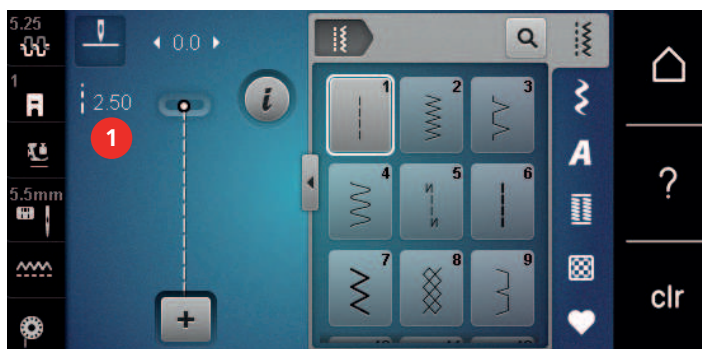
- > Turn the «Upper Multi-function Knob» to the left to narrow the stitch width.
- > Turn the «Upper Multi-function Knob» to the right to widen the stitch width.
- > To call up further setting options, tap the icon «Stitch width» (1).



Changing the Stitch Length

- > Turn the «Lower Multi-function Knob» to the left to shorten the stitch length.
- > Turn the «Lower Multi-function Knob» to the right to elongate the stitch length.

- > To call up other setting options, tap «Stitch Length» (1).



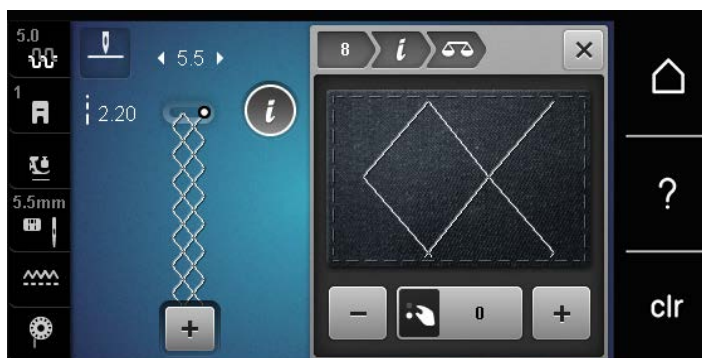
Correcting the Balance

Different fabrics, threads and stabilizers can affect the programmed stitch patterns so that they cannot be sewn out correctly. The electronic balance can correct these deviation and the stitch pattern can be adjusted optimally to the selected fabric.

- > Select a stitch pattern or alphabet.
- > Sewing stitch pattern.
- > Tap «i-Dialog».



- > Tap «Balance».
 - A preview of the stitch pattern is displayed.



- > To correct the longitudinal direction of the stitch pattern, turn the «Lower Multi-function Knob» until the preview of the stitch pattern matches the stitch pattern sewn on the fabric.
- > Altered Balance settings can be saved for each stitch in the «Personal Memory» .
- > Altered Balance settings only remain valid until the «Clear Settings» is pushed or the machine is switched off.



Programming Pattern Repeat

Stitch patterns can be repeated up to nine times.

- > Select a stitch pattern or alphabet.
- > Tap «i-Dialog».



- > To sew the stitch pattern 1x, tap «Pattern Repeat» 1x.
- > To repeat the stitch pattern up to 9 times, tap «Pattern Repeat» 2 up to 9x.
- > To deactivate the pattern repeat, tap and hold «Pattern Repeat».

Mirror Image of Stitch Patterns

- > Select a stitch pattern or alphabet.
- > Tap «i-Dialog».





> To mirror the stitch pattern from left to right, tap «Mirror Image Left/Right».



> To mirror the stitch pattern in sewing direction, tap «Mirror Image Up/Down».

Quick Reverse

- > Select a stitch pattern or alphabet.
- > To switch immediately to sewing in reverse when pushing the button «Quick Reverse», select Needle Stop Down (permanent).
- > Program needle stop up (permanent) to sew another stitch forward before the machine switches to reverse sewing.



> Push and hold the button «Quick Reverse».

Permanent Quick Reverse

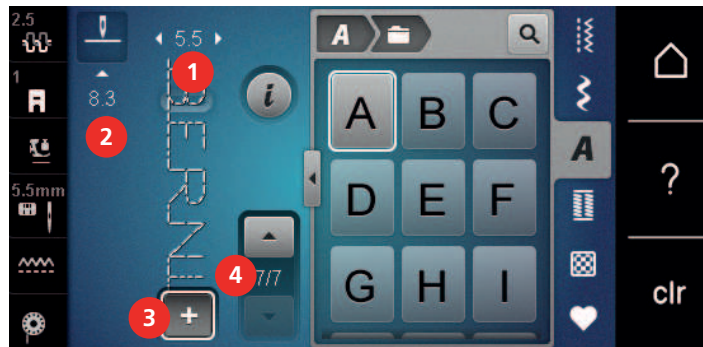
- > Select a stitch pattern or alphabet.
- > Tap «i-Dialog».



- > To sew permanently in reverse, tap «Permanent Reverse Sewing».
 - The machine sews permanently in reverse until «Permanent Reverse Sewing» is tapped again.

5.5 Combining Stitch Patterns

Overview Combi Mode



- | | | | |
|---|-----------------|---|--|
| 1 | «Stitch Width» | 3 | «Combination Mode/Single Mode» |
| 2 | «Stitch Length» | 4 | Individual Stitch Pattern within the Combination |

Creating Stitch Pattern Combinations

In the Combi Mode stitch patterns and alphabets can be combined according to your wish. By combining any alphabet letters, the logo BERNINA can be created.



- > Tap «Combination Mode/Single Mode».

> Select the desired stitch patterns.



> To get back to the Single Mode, tap «Combination Mode/Single Mode» again.

Saving a Stitch Pattern Combination

To use an individually created stitch pattern combinations again, they can be saved in the folder «Personal Memory».

Prerequisite:

- A stitch pattern combination has been created.



> Tap «Personal Memory».



> Tap «Save Stitch Pattern».



> To save the stitch pattern combination, tap «Confirm».

Loading a Stitch Pattern Combination



> Tap «Combination Mode/Single Mode».



> Tap «Personal Memory».



> Tap «Loading a Stitch Pattern Combination».

> Select a stitch pattern combination.

Overwriting a Stitch Pattern Combination

Prerequisite:

- A stitch pattern combination has been created.



> Tap «Personal Memory».



> Tap «Save Stitch Pattern».

> Select the stitch pattern combination which is to be overwritten.



> To overwrite the stitch pattern combination, tap «Confirm».




Deleting a Stitch Pattern Combination

Prerequisite:

- A stitch pattern combination has been created.



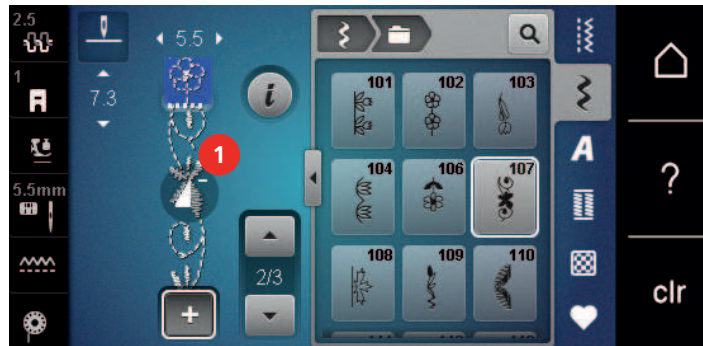
> Tap «i-Dialog».

-  > Tap «Edit Entire Combination».
-  > Tap «Deleting».
-  > Tap «Confirm».

Editing a Single Stitch Pattern

Prerequisite:

- A stitch pattern combination has been created.
- > To select a single stitch pattern, tap the desired position (1) within the stitch pattern combination.




-  > To edit the single stitch pattern, tap «i-Dialog».

Deleting a Single Stitch Pattern

Prerequisite:

- A stitch pattern combination has been created.
- > Tap the desired stitch pattern (1) within the stitch pattern combination.



-  > Tap «i-Dialog».
-  > Tap «Deleting».

Adding a Single Stitch Pattern

The new stitch pattern is always inserted after the selected stitch pattern.

Prerequisite:

- A stitch pattern combination has been created.

- > To select a single stitch pattern, tap the desired position (1) within the stitch pattern combination.



- > Select a new stitch pattern.

Mirroring a Stitch Pattern Combination

Prerequisite:

- A stitch pattern combination has been created.



- > Tap «i-Dialog».



- > Tap «Edit Entire Combination».



- > To mirror the whole stitch pattern combination from left to right, tap, «Mirror Image Left/Right».
- > To reset the changes and revert to the default settings, tap «Mirror Image Left/Right».

Securing a Stitch Pattern Combination

Prerequisite:

- A stitch pattern combination has been created.
- > Select the desired position within the stitch pattern combination where the stitch pattern combination is to be secured.



- > Tap «i-Dialog».



- > Tap «Edit Combination at Cursor Position».



- > Tap «Securing Stitches».
 - Every single pattern of the stitch pattern combination can be secured at the start or at the end.

Programming Pattern Repeat

Prerequisite:

- A stitch pattern combination has been created.



- > Tap «i-Dialog».



- > Tap «Edit Entire Combination».



- > To repeat the stitch pattern combination, tap «Pattern Repeat» 1x.
- > To repeat the stitch pattern combination up to 9x, tap «Pattern Repeat» again.
- > To deactivate the pattern repeat, tap and hold «Pattern Repeat» or tap «Clear Settings».

5.6 Administering Stitch Patterns

Saving Stitch Patterns in Personal Memory

In the folder «Personal Memory» any stitch patterns, also those which have been individually edited, can be saved.

- > Select a stitch pattern, alphabet or buttonhole.
- > Edit the stitch pattern.
- > Tap «Personal Memory».



- > Tap «Save Stitch Pattern».
- > Select the file where the pattern is to be saved.



- > Tap «Confirm».

Overwriting Stitch Patterns from the Personal Memory

Prerequisite:

- The stitch pattern is saved in the personal memory.

- > Select a stitch pattern, alphabet or buttonhole.
- > Edit the stitch pattern.
- > Tap «Personal Memory».



- > Tap «Save Stitch Pattern».
- > Select the file where the stitch pattern to be overwritten has been saved.
- > Select the stitch pattern which should be overwritten.



- > Tap «Confirm».

Loading Stitch Patterns from the Personal Memory

Prerequisite:

- The stitch pattern is saved in the personal memory.

- > Tap «Personal Memory».



- > Tap «Load Embroidery Design».
- > Select the file where the stitch pattern has been saved.
- > Select the stitch pattern.

Deleting Stitch Patterns from the Personal Memory

Prerequisite:

- The stitch pattern is saved in the personal memory.

- > Tap «Personal Memory».



- > Tap «Deleting».
- > Select the file where the stitch pattern has been saved.
- > Select the stitch pattern.



- > To delete the stitch pattern, tap «Confirm».

5.7 Securing Stitches

Securing a Seam with the Button «Securing»



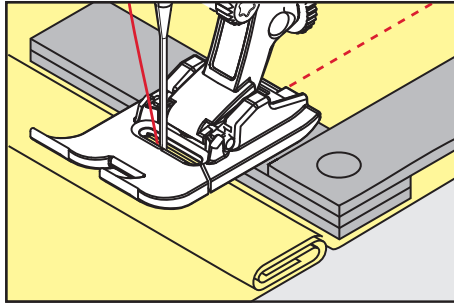
- > Pressing the «Securing Stitches» button before starting to sew.
 - The stitch pattern/stitch pattern combination is secured at the sewing start.

- > Press the «Securing Stitches» button while sewing.
 - The machine stops immediately and sews securing stitches.

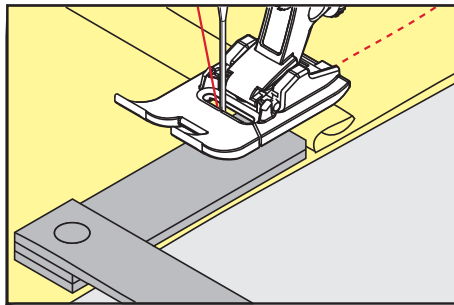
5.8 Height Compensation of Uneven Layers

If the presser foot is at an angle when sewing over a thick seam, the feed dog cannot grip the fabric and the sewing project cannot be sewn out properly.

- > Place 1 – 3 compensating plates as required from the back of the presser foot close to the needle to level the fabric layer.



- The presser foot is leveled with the sewing project.
- > Place 1 – 3 compensating plates as required from the front of the presser foot close to the needle to level the fabric layer.

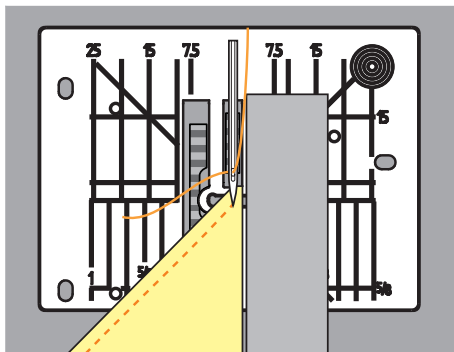


- The presser foot is leveled with the sewing project.
- > Sew until the complete presser foot has passed the thick seam.
- > Remove the plates of the height compensation.

5.9 Sewing Corners

When sewing corners, only a small section of the fabric is actually on the feed dog. Therefore it cannot grip the fabric well. By means of the height compensation tool the fabric can be fed evenly.

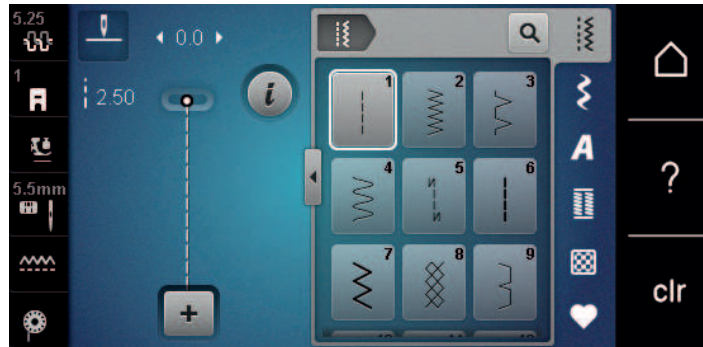
- > When the fabric edge is reached, stop the sewing process with needle position down.
- > Raise the presser foot.
- > Turn the fabric and place in desired position.
- > Place 1 – 3 compensating plates as required on the right of the presser foot close to the sewing project.
- > Lower the presser foot.

















- > Resume sewing until the sewing project is on the feed dog again.

6 Practical Stitches

6.1 Overview Practical Stitches



Stitch patterns	Stitch number	Name	Description
	1	Straight Stitch	To join seams, for topstitching and basting.
	2	Zigzag	To finish edges, to sew elastic seams, to sew on lace inserts and elastics.
	3	Vari-Overlock	For finishing edges, sewing together and simultaneously finishing elastic fabrics.
	4	Running Stitch	For darning and reinforcing fabric edges or attaching lace or rubber tape.
	5	Securing Program	For automatic securing at the start of the seam with forward and reverse stitches.
	6	Triple Straight Stitch	For reinforced seams on heavy fabrics and decorative effects.
	7	Triple Zig zag	For durable seams on strong fabrics, visible hems and decorative seams.
	8	Honeycomb Stitch	For stretch fabrics and hems, including with rubber threads.
	9	Blind Stitch	For blind hems on most fabric types and for shell edging on soft jerseys and fine fabric.
	10	Double Overlock	For simultaneously sewing together and finishing elastic fabrics.
	11	Superstretch Stitch	For highly stretch open seams.

Stitch patterns	Stitch number	Name	Description
	12	Gathering Stitch	For gathering with rubber threads and for flat joining seams on medium-weight fabrics.
	13	Stretch Overlock	For simultaneously sewing together and finishing elastic fabrics, as well as for flat joining seams.
	14	Tricot Stitch	For visible hems and seams in lingerie and sweaters and for mending tricot fabric.
	15	Universal Stitch	For flat joining seams, visible hems and decorative seams in strong fabrics such as felt and leather and for attaching rubber tape.
	16	Sewn-out Zigzag	For finishing and reinforcing fabric edges, for sewing on rubber tape and for decorative seams.
	17	Lycra Stitch	For flat joining seams, visible hems on Lycra fabric and for stitching over seams in foundation garments.
	18	Stretch Stitch	For stretchable seams and hems in woven and knitted fabrics.
	19	Reinforced Overlock	For overlock seams or flat joining seams on medium-weight knit fabrics and toweling.
	20	Knit Overlock	For stretchable seams and hems in woven and knitted fabric, for sewing and finishing.
	22	Simple Darning Program	For automatic darning in fine to strong fabrics.
	23	Reinforced Darning Program	For automatic darning in strong materials.
	24	Bartack Program	For reinforcing pocket openings, buttonhole bars and for sewing belt loops.
	25	Bartack Program	For reinforcing pocket openings, sewing belt loops and securing seam ends.
	26	Large Fly Stitch	For reinforcing pocket openings, zippers and slits in medium-weight to thick fabrics.

Due to a determined number of 6 stitches sewn forwards and 6 stitches sewn in reverse, the securing is regular.

Prerequisite:

- The Reverse Pattern Foot #1 is fitted.

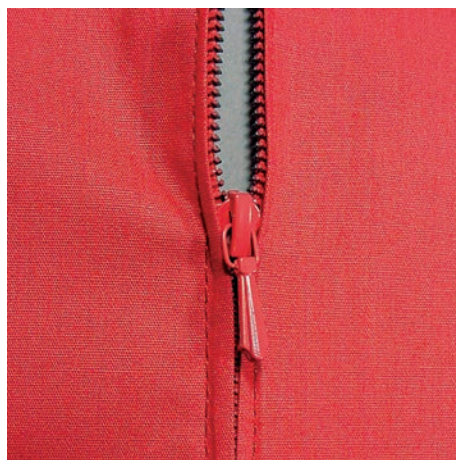


- > Tap «Practical Stitches».
- > Select Securing Program No. 5.
- > Press the foot control.
 - The machine secures automatically.
- > Sew the seam in the desired length.



- > Push the button «Quick Reverse».
 - The machine secures automatically and stops at the end of the securing program.

6.4 Sewing in the Zipper

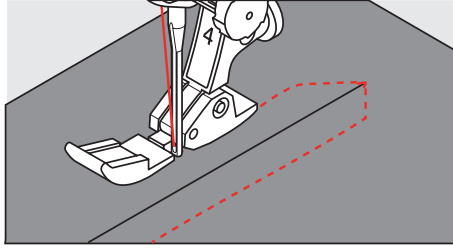


As the fabric feed can be difficult when starting to sew, it is recommended to hold the threads firmly or to pull the fabric slightly to the back for a few stitches or to sew 1 – 2 cm reverse first.



- > Fit the Reverse Pattern Foot #1.
- > Tap «Practical Stitches».
- > Select Straight Stitch No. 1.
- > Sew the seam up to the zipper beginning.
- > Sew the securing stitches.
- > Close the zipper length with long stitches.
- > Finish the seam allowances.
- > Iron the seam.
- > Open the zipper length.
- > Baste the zipper under the fabric so that the fabric folded edges meet over the center of the zipper.
- > Open the zipper a few centimeters.
- > Fit the Zipper Foot #4.
- > Move the needle position to the right.
- > Use the Free Hand System to raise the presser foot and to position the sewing project.
- > Start sewing from top left.
- > Guide the foot so that the needle stitches along the zipper coils.
- > Stop in front of the zipper pull with needle position down.
- > Raise the presser foot.
- > Close the zipper.
- > Continue to sew and stop in front of the base of the zipper with needle position down.
- > Raise the presser foot and turn the sewing project.
- > Sew across the other side of the zipper and stop with needle position down.
- > Raise the presser foot and turn the sewing project.

- > Sew the second side from bottom to top.



6.5 Sewing both Sides of the Zipper from Bottom to Top

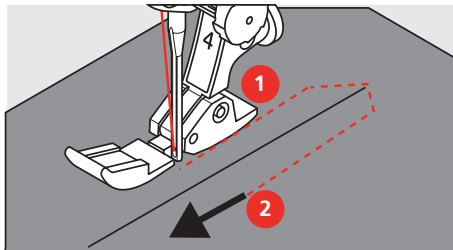
For fabrics with pile, such as velvet, it is recommended to sew in the zipper on both sides from bottom to top.



When the fabric is firm or densely woven, it is recommended to use a needle with the size 90 – 100. This results in an even stitch formation.



- > Fit the Reverse Pattern Foot #1.
- > Tap «Practical Stitches».
- > Select Straight Stitch No. 1.
- > Sew the seam up to where the zipper starts.
- > Sew the securing stitches.
- > Close the zipper length with long stitches.
- > Finish the seam allowances.
- > Iron the seam.
- > Open the zipper length.
- > Baste the zipper under the fabric so that the fabric folded edges meet over the center of the zipper.
- > Fit the Zipper Foot #4.
- > Move the needle position to the right.
- > Use the Free Hand System to raise the presser foot and to position the sewing project.
- > Start sewing in the center of the seam at the end of the zipper.
- > Sew diagonally along the edge of the zipper coils.
- > Sew the first side (1) from bottom to top.
- > Stop in front of the zipper pull with needle position down.
- > Raise the presser foot.
- > Open the zipper as far as behind the presser foot.
- > Lower the presser foot and continue sewing.
- > Move the needle position to the left.
- > Sew the second side (2) in exactly the same way from bottom to top.



6.6 Sewing Triple Straight Stitch

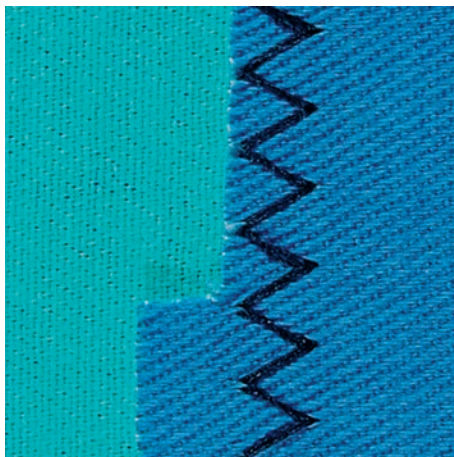


The Triple Straight Stitch is especially suitable for durable seams and for firm, densely woven fabrics such as denim and corduroy. For firm or densely woven materials it is recommended to fit the Jeans Foot #8. This will help to sew denim or canvas. For decorative topstitching, the stitch length can be elongated.

- > Fit the Reverse Pattern Foot #1.
- > Tap «Practical Stitches».
- > Select Triple Straight Stitch No. 6.



6.7 Sewing Triple Zig Zag

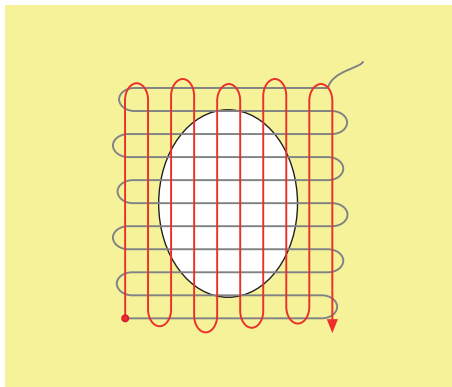


In firm fabrics, particularly for denim fabrics, deckchair covers, awnings. Hems on items that are frequently washed. Finish the seam edges first.

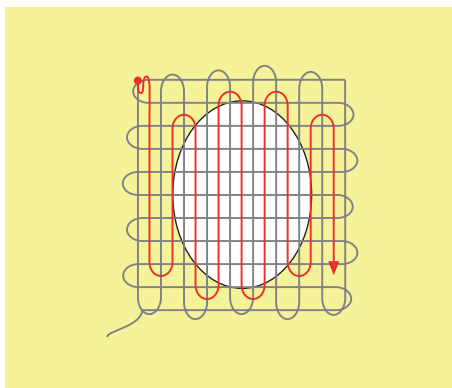
- > Fit the Reverse Pattern Foot #1.
- > Tap «Practical Stitches».
- > Select Triple Zig zag No. 7.



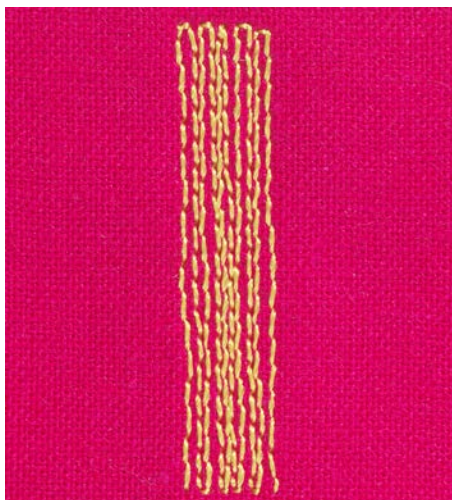
- > Turn the sewing project by 90°.
- > Sew the first rows not too close.



- > Turn the sewing project by 180°.
- > Sew another loose row.



6.9 Automatic Darning



The Simple Darning Program No. 22 is particularly suitable for quick darning of worn areas or tears. It is recommended to use fine material as a backing for the worn and damaged areas or to stick an adhesive interlining. The Simple Darning Program No. 22 replaces the longitudinal threads in all fabrics. If the darning area becomes distorted, correct with the balance.

- > Fit the Reverse Pattern Foot #1 or the Buttonhole Foot with Slide #3A (optional accessory).
- > Tap «Practical Stitches».
- > Select Simple Darning Program No. 22.
- > Hoop light-weight materials in the round embroidery hoop (optional accessory).
 - The darning area stays evenly taut and cannot be distorted.
- > Start sewing top left.



- > Sew the first row.
- > Stop the machine.
- U > Tap «Quick Reverse».
 - The length is programmed.
- > Finish sewing the Darning Program.
 - The machine stops automatically.

6.10 Reinforced Darning, Automatic

NOTICE! This program only works in combination with the Buttonhole Foot with Slide #3A which in some markets is only available as an optional accessory from specialized BERNINA retailers.



The Reinforced Darning Program No. 23 is particularly suitable for quick darning of worn areas or tears. The Reinforced Darning Program No. 23 replaces the longitudinal threads in all fabrics.



If the Darning Program does not cover the whole worn or damaged area, it is recommended to reposition the work and sew the Darning Program again. The length is programmed and can be repeated as often as desired.

- > Fit the Buttonhole Foot with Slide #3A.
- > Tap «Practical Stitches».
- > Select Reinforced Darning Program No. 23.
- > Hoop light-weight materials in the round embroidery hoop (optional accessory).
 - The darning area stays evenly taut and cannot be distorted.
- > Start sewing top left.
- > Sew the first row.
- > Stop the machine.
- U > Push the button «Quick Reverse».
 - The darning length is programmed.
- > Finish sewing the Darning Program.
 - The machine stops automatically.



6.11 Finishing Edges



Zigzag No. 2 is suitable for all fabrics. It can be used for elastic seams as well as for decorative work. Use darning thread for fine materials.

Prerequisite:

- The edge of the fabric should lie flat and not roll.
- > Fit the Reverse Pattern Foot #1.
- > Tap «Practical Stitches».
- > Select Zigzag No. 2.
- > Neither select too wide a stitch nor too long a stitch.
- > Guide the edge of the fabric into the center of the presser foot, so that the needle goes into the fabric on one side and over the edge into the air on the other side.



6.12 Sewing Double Overlock



A double overlock seam is suitable for looser knit fabric and for cross seams in woven fabric. When working with jersey, a jersey needle should be used to prevent damaging the knit fabric. When sewing stretch materials, use a stretch needle.

- > Fit the Reverse Pattern Foot #1 or Overlock Foot #2.
- > Tap «Practical Stitches».
- > Select Double Overlock No. 10.

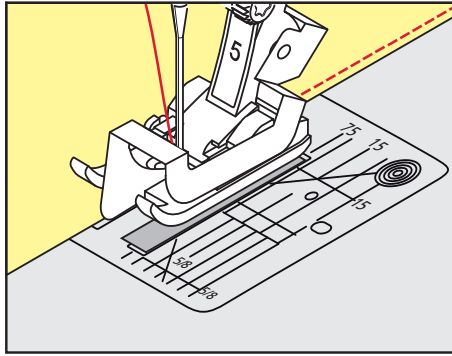


6.13 Narrow Edgestitching

- > Fit the Blindstitch Foot #5 or Edgestitch Foot #10.
- > Tap «Practical Stitches».
- > Select Straight Stitch No. 1.
- > Place the left-hand edge against the guide of the Blindstitch foot.

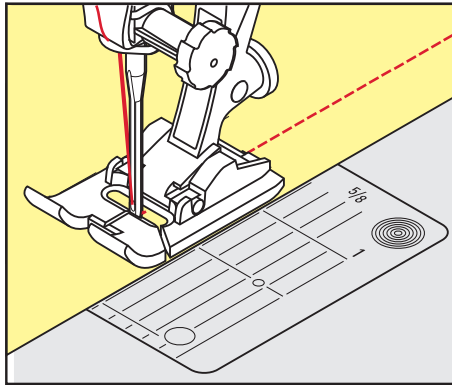


- > Select the left-hand needle position at the desired distance to the edge.



6.14 Wide Edgestitching

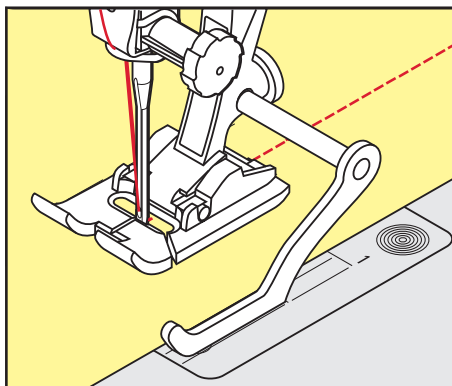
- > Fit the Reverse Pattern Foot #1.
- > Tap «Practical Stitches».
- > Select Straight Stitch No. 1.
- > Guide the edge along the presser foot or at a distance of 1–2.5 cm along the marks on the stitch plate.
- > Select the needle position at the desired distance to the edge.



6.15 Edgestitching using the Seam Guide (optional accessory)

When sewing parallel wider lines, it is recommended to guide the seam guide (optional accessory) along a sewn line.

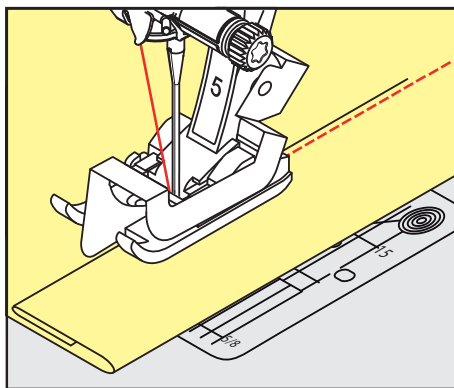
- > Fit the Reverse Pattern Foot #1.
- > Tap «Practical Stitches».
- > Select Straight Stitch No. 1.
- > Loosen the screw on the back of the presser foot.
- > Insert the seam guide into the hole in the presser foot.
- > Adjust the width as required.
- > Tighten the screw.
- > Guide the folded edge along the seam guide.



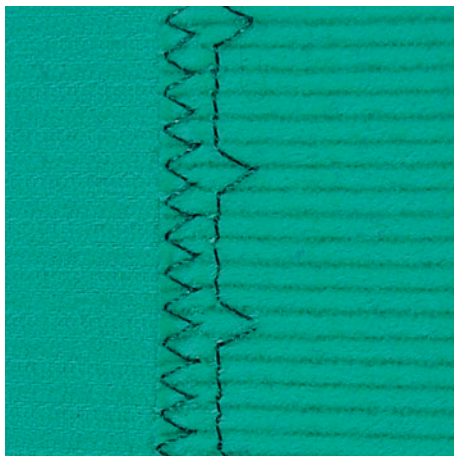
6.16 Sewing Hem Edges

When using the Blindstitch Foot #5, it is recommended to set the needle position to the far left or right. With the Reverse Pattern Foot #1 and the Edgestitch Foot #10, all needle positions are possible.

- > Fit the Blindstitch Foot #5 or the Reverse Pattern Foot #1 or the Edgestitch Foot #10.
- > Tap «Practical Stitches».
- > Select Straight Stitch No. 1.
- > Place the inner upper hem edge on the right against the guide of the Blindstitch Foot.
- > Select the needle position far right in order to sew along the upper hem edge.



6.17 Sewing Blind Hems



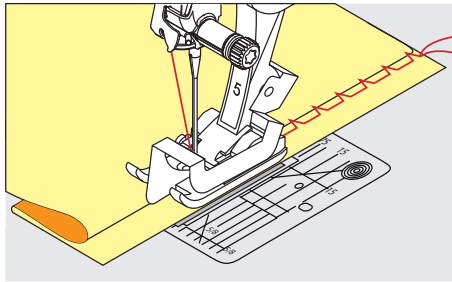
For invisible hems in medium to heavy weight cotton, wool and blended materials.

Prerequisite:

- The fabric edges are finished.
- > Fit the Blindstitch Foot #5.
- > Tap «Practical Stitches».
- > Select Blind Stitch No. 9.
- > Fold the fabric so that the finished fabric edge is on the right side.
- > Place the fabric under the presser foot and move the folded edge against the metal guide on the presser foot.
- > Guide the folded edge evenly along the metal guide of the presser foot to sew the stitches evenly deep.
 - Make sure that the needle only pierces the edge of the fold.



- > After sewing about 10 cm (ca. 3.93 inch) check both sides of the fabric and adjust the width again if necessary.



6.18 Sewing visible Hems

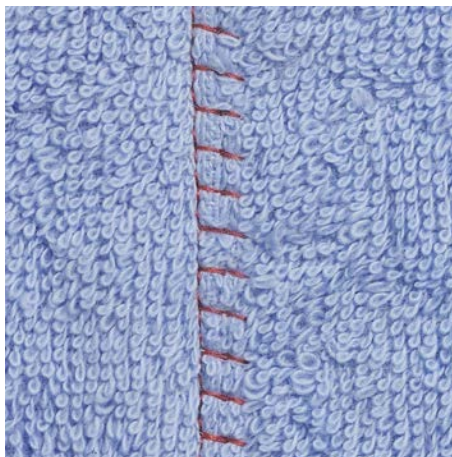


The visible hem is particularly suitable for elastic seams in tricot made of cotton, wool, synthetic and mixed fibers.



- > Fit the Reverse Pattern Foot #1.
- > Tap «Practical Stitches».
- > Select Tricot Stitch No. 14.
- > Iron the hem and baste if necessary.
- > Reduce the Presser Foot Pressure if necessary.
- > Sew the hem in the desired depth on the right side of the fabric.
- > Trim off the remaining fabric on the wrong side of the fabric.

6.19 Sewing flat Joining Seams



The flat joining seam is especially suitable for long-pile or thick materials such as terrycloth, felt or leather.

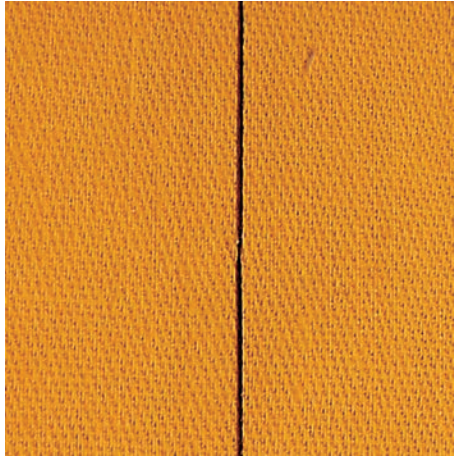
- > Fit the Reverse Pattern Foot #1.





- > Tap «Practical Stitches».
- > Select Stretch Overlock No. 13.
- > Overlap the fabric edges.
- > Sew along the fabric edge.
- > To get a very flat, durable seam, make sure the needle stitches right over the top edge of the fabric into the bottom fabric.

6.20 Sewing Basting Stitches



When sewing basting stitches, it is recommended to use a fine darning thread. This is easier to remove. The basting stitch is suitable for sewing projects where a very long stitch length is required.



- > Fit the Darning Foot #9 (optional accessory).
- > Lower the feed dog.
- > Tap «Practical Stitches».
- > Select Manual Basting Stitch No. 30.
- > Pin the fabric layers at a right angle to basting direction to prevent the layers from slipping.
- > Hold the threads and sew 3 – 4 securing stitches at the beginning.
- > Sew a stitch and pull the fabric back at the desired stitch length.
- > Sew a stitch.
- > At the end sew 3 – 4 securing stitches.



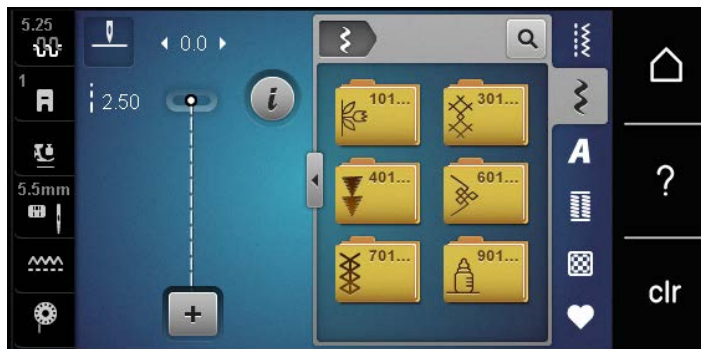
7 Decorative Stitches







7.1 Overview Decorative Stitches

Easier or more difficult decorative stitches come into their own depending on the type of fabric.

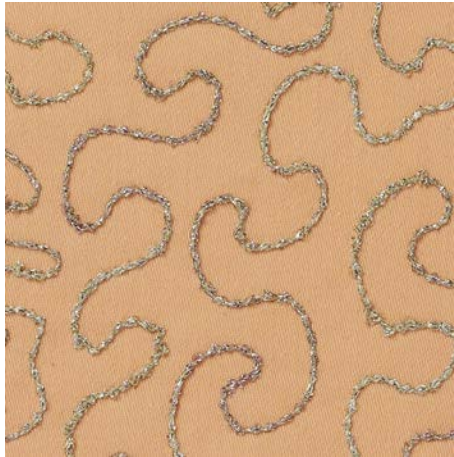
- Decorative stitches which are programmed with simple straight stitches are particularly appropriate for lightweight materials, e. g. the Decorative Stitch No. 101.
- Decorative stitches which are programmed with triple straight stitches or with a few satin stitches are particularly appropriate for medium-weight materials, e. g. the Decorative Stitch No. 107.
- Decorative stitches which are programmed with satin stitches are particularly appropriate for heavyweight materials, e. g. the Decorative Stitch No. 401.

For a perfect stitch formation it is of advantage to use the same thread color for upper and bobbin thread and a stabilizer. With pile or longfiber materials, it is recommended to use an additional water-soluble stabilizer, which can be easily removed after sewing, on the right side of the fabric.



Decorative Stitch	Category	Name
	Category 100	Nature Stitches
	Category 300	Cross Stitches
	Category 400	Satin Stitches
	Category 600	Geometric Stitches
	Category 700	Heirloom Stitches
	Category 900	Children Stitches

7.2 Bobbin-Play



The bobbin can be filled with different thread material. For free-motion stitching to add texture. This method is similar to “normal” free-motion sewing, but is done on the **wrong** side of the fabric.

Reinforce the area to be sewn with embroidery stabilizer. The design can be drawn on the wrong side of the fabric. You can also draw the design on the front side of the fabric. The lines can be followed with a freely guided straight stitch using polyester, cotton or rayon thread. The rows of stitching are visible on the wrong side of the fabric, and they serve as guidelines for the bobbin-thread sewing.

We recommend guiding your project evenly under the needle at a consistent speed, following the lines of the design. The stabilizer must be removed after sewing.

Sew a sample first to check what the result looks like on the wrong side of the fabric.

Not all decorative stitches are suitable for this technique. Simple decorative stitches provide best results. Avoid compact stitch types and satin stitches.

NOTICE

Inappropriate Bobbin Case is Used

Damage to the bobbin case.

> Use the bobbinwork bobbin case (optional accessory).








- > Fit the Open Embroidery Foot #20.
- > Tap «Decorative Stitches».
- > Select an appropriate decorative stitch.
- > Turn the «Upper Multi-function Knob» and the «Lower Multi-function Knob» to set the stitch length and stitch width so that a beautiful stitch formation can be achieved even when sewing with thick thread.



- > To adjust the upper thread tension, tap «Upper Thread Tension».

Overview Pintuck Feet

Pintuck Foot	Number	Description
	#30 (optional accessory)	3 grooves For heavy-weight fabrics. In combination with the 4 mm twin needle
	#31 (optional accessory)	5 grooves For heavy to medium-weight fabrics. In combination with the 3 mm twin needle
	#32 (optional accessory)	7 grooves For light to medium-weight fabrics. In combination with the 2 mm twin needle
	#33 (optional accessory)	9 grooves For very light fabrics (without extra cord). In combination with the 1 or 1.6 mm twin needle
	#46C (optional accessory)	5 grooves In combination with the 1.6 – 2.5 mm twin needle For very light to medium-weight fabrics.

Working with Cord

The pintucks look more distinctive and relief-like when they are sewn with a supplementary cord. Choose a cord that fits well into the grooves of the respective foot. The cord must be colorfast and shrink-proof.

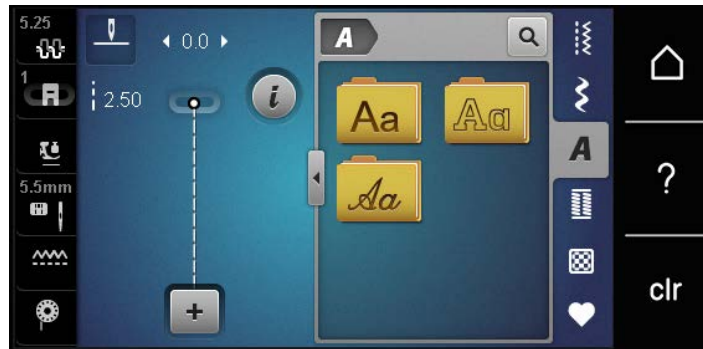
- > Switch off the machine.
- > Remove the needle.
- > Remove the presser foot.
- > Remove the stitch plate.
- > Open the bobbin cover.
- > Pull the cord through the hook opening from the bottom and through the opening of the stitch plate.
- > Refit stitch plate.
- > Close the bobbin cover.

8 Alphabets

8.1 Overview Alphabet

Block, Double block and Script alphabets can be sewn in lower case letters.

For a perfect stitch formation, use the same thread color for upper and bobbin threads. The fabric can be reinforced with embroidery stabilizer on the wrong side. When working with pile or napped fabrics, e.g. toweling, use an additional, water-soluble stabilizer on the right side of the fabric.



Stitch patterns	Name
ABCabc	Block alphabet
ABCabc	Double-Block
<i>ABCabc</i>	Script (Italics)

8.2 Creating Lettering



Sewing a test sample with the thread, the actual fabric and stabilizer you intend to use is recommended. Make sure that the fabric is fed evenly and lightly, ensuring that it cannot push against or catch on anything. The fabric shouldn't be pulled, pushed or held back.



- > Tap «Alphabets».
- > Select the font.



- > To create a combination, tap «Combination Mode/Single Mode».
- > To open the extended Enter Mode, tap «Increasing/Decreasing the Display Size» (1).




- > Select the letters.
- > To use upper-case letters, tap «Upper Case Characters» (standard setting).




- > To use lower-case letters, tap «Lower Case Characters».



- > To use figures and mathematical symbols, tap «Numbers and Mathematical Characters».

 > To use special characters, tap «Special Characters».

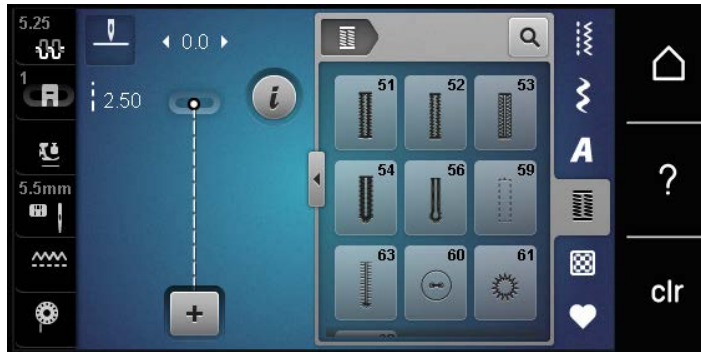












 > To delete individual syllables of the entered text, tap «Deleting».
> To close the extended Enter Mode, tap «Increasing/Decreasing the Display Size» again.

9 Buttonholes

9.1 Overview Buttonholes

To be able to create the right buttonhole for every button, every purpose and also for every garment, the BERNINA 435 comes with an extensive collection of buttonholes. The corresponding button can be sewn on automatically. Eyelets can also be sewn.

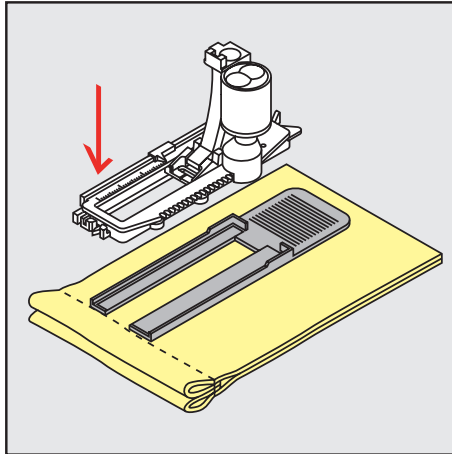


Stitch patterns	Stitch number	Name	Description
	51	Standard Buttonhole	For light to medium-weight fabrics. e.g. blouses, dresses and bed linen.
	52	Narrow Standard Buttonhole	For light to medium-weight fabrics, e.g. blouses, dresses, children's and baby clothes, crafts.
	53	Stretch Buttonhole	For all elastic fabrics.
	54	Round Buttonhole with Normal Bartack	For medium-weight to heavy fabrics. e.g. dresses, jackets, coats and rainwear.
	56	Keyhole Buttonhole	For heavy, non-stretch fabrics, e.g. jackets, coats and leisurewear.
	59	Straight Stitch Buttonhole	For staystitching and reinforcing buttonholes and as button hole edging, especially for buttonholes in leather and imitation leather.
	60	Button Sew-on Program	Sews buttons with 2 or 4 holes.
	61	Eyelet with Small Zigzag	Openings for cords or narrow ribbons and for decorative work.
	62	Eyelet with Straight Stitch	Openings for cords or narrow ribbons and for decorative work.
	63	Heirloom Buttonhole	For handlook stitching effects on clothes and handicrafts on light to medium-weight fabrics.

9.2 Making Use of the Height Compensation Tool

When a buttonhole is to be sewn at right angles to the project edge, it is recommend to use the height compensation plates (optional accessory).

- > Place the plates from the back between the sewing project and the bottom of the slide to the thick part of the sewing project.

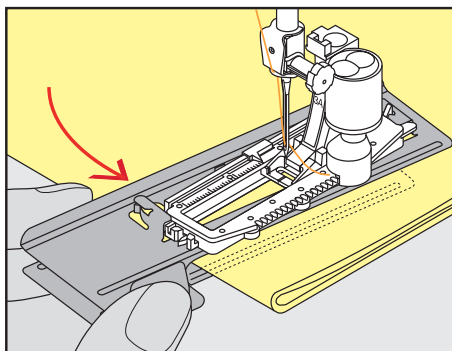


- > Lower the presser foot.

9.3 Using the Compensation Plate

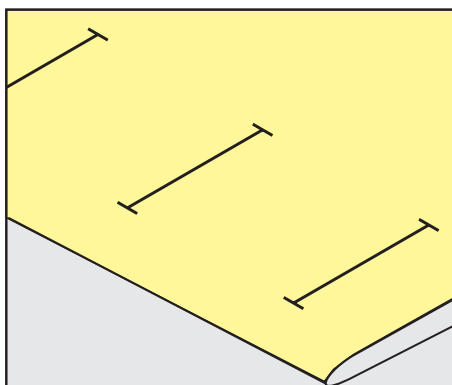
For sewing a buttonhole in problematic fabrics, it is recommended to use the Height Compensation Tool (optional accessory). The Height Compensation Tool can be used in combination with the Buttonhole Foot with Slide #3A.

- > Insert the compensation plate carefully from the side.

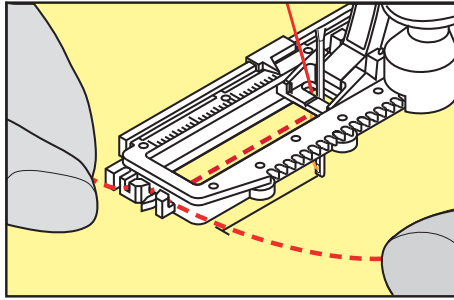


9.4 Marking Buttonholes

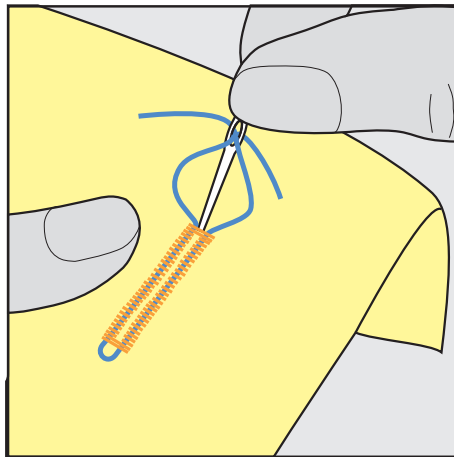
- > For the buttonholes to be sewn manually, mark the position and the length on the fabric using chalk or a water-soluble pen.



- > Pull the cord to the front on the left side under the Buttonhole Foot with Slide.



- > Pull the cord ends into the slits.
- > Lower the Buttonhole Foot with Slide.
- > Sew the buttonhole in the usual manner.
- > Pull the cord loop until the loop disappears in the bartack.
- > Pull the ends of the cord through to the wrong side of the fabric (using a hand sewing needle) and knot or secure them with stitches.



9.6 Sewing a Test Sample

Always sew a test sample of the buttonhole on the same fabric: It is recommended to use the same stabilizer and to select the same buttonhole. The test sample should also be sewn in the respective direction. By sewing a test sample the settings can be adjusted until the sewing result is satisfying.

It is worth underlaying the buttonholes with the Straight Stitch Buttonhole No. 59 when working with soft loosely woven materials and for buttonholes which are severely strained. This is also recommended to reinforce buttonholes in leather, vinyl or felt.

Alterations of the Balance when sewing a manual standard buttonhole as well as the Keyhole and the Round Buttonhole affect both beads in the same way. With the manual keyhole or round buttonhole, the alterations affect both sides in the opposite way.

If the Stitch Counter function is used, and alterations are made concerning the Balance, the alterations affect both buttonhole beads differently.



- > Tap «Buttonholes».
- > Select the buttonhole.
- > Select and fit the desired presser foot.
- > Place the fabric under the presser foot and lower the presser foot.
- > Press the foot control carefully and start sewing. Guide the fabric slightly.
- > Check the Balance while sewing and adjust if necessary.
- > Check the test sample and make further amendments if necessary.



9.7 Determining the Buttonhole Length with Buttonhole Foot #3

When the Buttonhole Foot #3 is used, the buttonhole length must be determined via the function Stitch Counter. The stitch counter function is suitable for all types of buttonholes. The left buttonhole bead is sewn forward, the right buttonhole bead is sewn in reverse. If alterations are made to the Balance, the Stitch Counter function has to be saved for every buttonhole separately.

Prerequisite:

- The Buttonhole Foot #3 is fitted.



- > Tap «Buttonholes».
- > Select the buttonhole.



- > Tap «i-Dialog».



- > Tap «Programming the Length via the Stitch Counter».
- > Sew the required length of the buttonhole.
- > Stop the machine.



- > The machine sews the lower bartack and the second bead in reverse when the button «Quick Reverse» is pushed.
- > Stop the machine at the height of the first stitch.
- > The machine sews the upper bartack and the securing stitches when the button «Quick Reverse» is pushed again.
 - The length of the buttonhole remains saved and every subsequent buttonhole is sewn identically until the machine is switched off.

9.8 Determining the Buttonhole Length with the Buttonhole Foot with Slide #3A



The button can be centered in the yellow circle on the display. By turning the «Upper/Lower Multifunction knobs», the yellow circle can be enlarged or downsized to determine the diameter of the button.

2 mm is automatically added to the diameter of the button for the buttonhole length. If the diameter of the button is 14 mm, for example, 16 mm is calculated for the buttonhole length.

Prerequisite:

- The Buttonhole Foot with Slide #3A is fitted.



- > Tap «Buttonholes».
- > Select the buttonhole.



- > Tap «i-Dialog».



- > Tap «Direct Entry Buttonhole Length».
- > To adjust the buttonhole length, turn the «Upper Multi-function Knob» or the «Lower Multi-function Knob».

9.9 Sewing the Manual 7-step Buttonhole with the Buttonhole Foot #3

The length of the buttonhole is determined manually when sewing. The bartack, eye and securing stitches are preprogrammed. The individual steps can also be selected by scrolling using the arrow icons or by pressing the button «Quick Reverse».

Prerequisite:

- The Buttonhole Foot #3 is fitted.



- > Tap «Buttonholes».
- > Select Standard Buttonhole No. 51.

Buttonholes



- > Tap «i-Dialog».



- > Tap «Manual Length Adjustment».
 - Step 1 is activated in the display to start the buttonhole.
- > Sew the required length of the buttonhole.
 - Step 2 becomes active when sewing starts.



- > Stop when the required length of the buttonhole or the length marking is reached.
- > Step 3 appears by tapping «Scroll Down».
 - The machine sews straight stitches in reverse.
- > Stop the machine at the level of the first stitch where the buttonhole begins.
- > Step 4 appears by tapping «Scroll Down».
 - The machine sews the upper bartack and stops automatically.
- > Step 5 appears by tapping «Scroll Down».
 - The machine sews the second bead.
- > Stop the machine at the level of the last stitch of the first bead.
- > Step 6 appears by tapping «Scroll Down».
 - The machine sews the lower bartack and stops automatically.
- > Step 7 appears by tapping «Scroll Down».
 - The machine secures and stops automatically.

9.10 Sewing the Manual 5-step Buttonhole with the Buttonhole Foot #3

The length of the buttonhole is determined manually when sewing. The bartack, eye and securing stitches are preprogrammed. The individual steps can also be selected by scrolling using the arrow icons or by pressing the button «Quick Reverse».

Prerequisite:

- The Buttonhole Foot #3 is fitted.



- > Tap «Buttonholes».
- > Select Round Buttonhole with Normal Bartack No. 54.



- > Tap «i-Dialog».



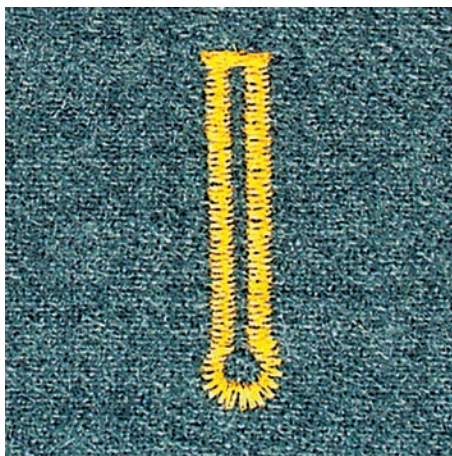
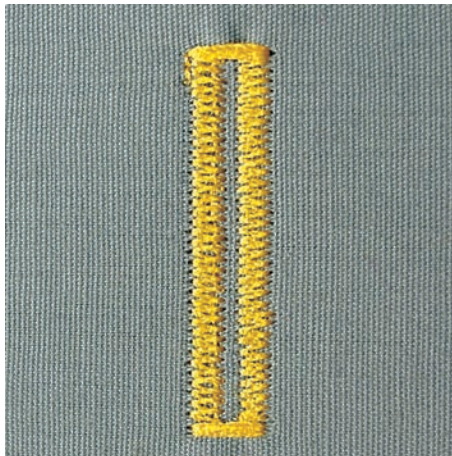
- > Tap «Manual Length Adjustment».
 - Step 1 is activated in the display to start the buttonhole.

- > Sew the required length of the buttonhole.
 - Step 2 is activated.



- > Stop when the required length of the bead or the length marking is reached.
- > Step 3 appears by tapping «Scroll Down».
- > The machine sews the curve or the eye and stops automatically.
- > Step 4 appears by tapping «Scroll Down».
 - The machine sews the second bead in reverse.
- > Stop the machine at the level of the first stitch where the buttonhole begins.
- > Step 5 appears by tapping «Scroll Down».
 - The machine sews the upper bartack and secures automatically.

9.11 Sewing a Buttonhole automatically with the Buttonhole Foot with Slide #3A



When the Buttonhole Foot with Slide #3A is used, the length of the buttonhole is measured automatically by the lens on the presser foot. The buttonhole will be exactly duplicated and the machine switches to the next step automatically when the maximum length is reached. The Buttonhole Foot with Slide #3A is suitable for

buttonholes at a length of 4 mm up to 31 mm, depending on the buttonhole type. The Buttonhole Foot with Slide #3A must lie perfectly flat on the fabric so that the length can be measured accurately. Programmed buttonholes are all at the same length and of the same nice look.

Prerequisite:

- The Buttonhole Foot with Slide #3A is fitted.



- > Tap «Buttonholes».
- > Select buttonhole No. 51 – 54, No. 56, 59 or 63.
- > Sew the required length of the buttonhole.



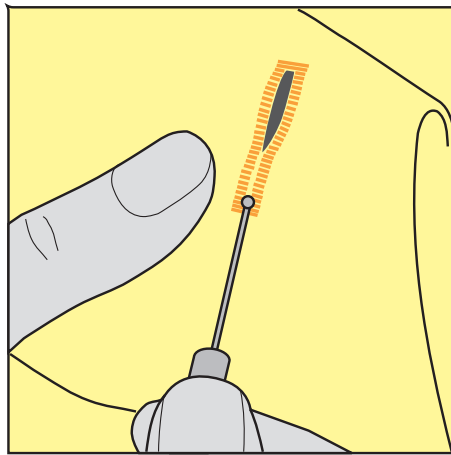
- > To program the length, push the button «Quick Reverse».



- > Push the button «Start/Stop» or press the foot control.
 - The machine finishes the buttonhole automatically. All subsequent buttonholes are sewn at the same length.

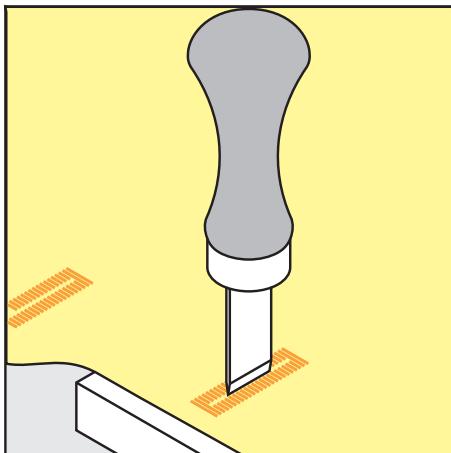
9.12 Cutting the Buttonhole Open with the Seam Ripper

- > Place a pin in each end of the buttonhole to avoid accidental cutting into ends of buttonhole.
- > Cut the buttonhole from both ends to the middle.



9.13 Cutting Open Buttonholes with the Buttonhole Cutter (Optional Accessory)

- > Place the fabric on an appropriate wood.



- > Position the cutter in the center of the buttonhole.
- > Press down on the cutter with your hand.

9.14 Sewing on a Button

The Button Sew-on Program can be used to sew on buttons with two or four holes, press studs or snap fasteners.

Recommended Sewing Program:	Button Sew-on Program No. 60
Recommended Presser Foot:	Button Sew-On Foot #18
Alternative Presser Feet:	<ul style="list-style-type: none"> • Reverse Pattern Foot #1/1C • Darning Foot #9 • Reverse Pattern Foot with Clear Sole #34/34C

Adjusting the Thread Shank

For buttons on thicker fabrics, increase the thread shank = the distance between the button and the fabric. Buttons sewn on thin fabrics or buttons for decorative purposes only are stitched without a «thread shank».

NOTICE! The adjustment of the thread shank is only possible when using the Button Sew-on Foot #18.

- > Loosen the screw on the back of the presser foot.
- > Push the bar upwards according to the thickness of the fabric.
- > Tighten the screw.

Sewing On Buttons

Prerequisite:

- The shank length is adjusted according the fabric thickness.
- The Button Sew-On Foot #18 or an alternative presser foot is fitted.
- The feed dog is lowered.



- > Tap «Buttonholes».
- > Select Button Sew-on Program No. 60.
- > Turn the handwheel until the bobbin thread comes up.
- > **NOTICE! The Button Sew-on Program always starts above the left hole of the button.** Position the button on the fabric. Place the button and the fabric beneath the needle so that the needle stitches into the left hole. For buttons with 4 holes, sew the first front pair of holes first.
- > Lower the presser foot.
- > Perform the first stitches in the left hole via the handwheel.
- > Keep turning the handwheel until the needle changes to the right hole. In doing so, check whether the needle goes into the right hole. If necessary, adjust the stitch width by turning the upper multi-function knob.
- > Hold the threads and push the foot control.
 - The machine sews on the button and stops automatically.
- > For increased stability, sew the Button Sew-on Program again.
- > Cut the threads with the machine. Alternatively, pull the sewing projects from under the sewing machine and trim the threads by hand. Pull the upper thread to the wrong side of the fabric and knot it with the bobbin thread.


9.15 Sewing Eyelets



For increased stability sew the eyelet twice. Adjust stitch with the balance if necessary.

Prerequisite:

- The Reverse Pattern Foot #1 or the Open Embroidery Foot #20 is fitted.



Buttonholes

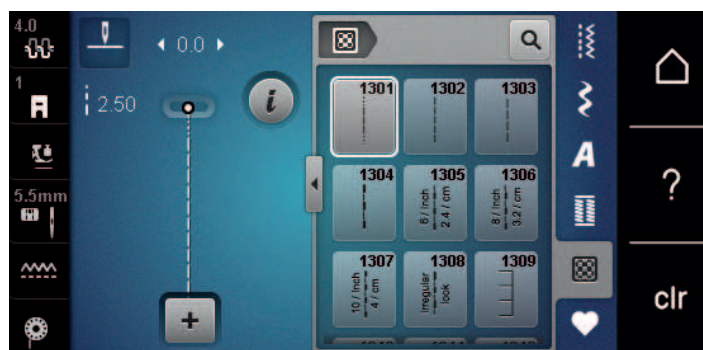


- > Tap «Buttonholes».
- > Select Eyelet with Small Zigzag No. 61 or Eyelet with Straight Stitch No. 62.
- > To alter the size of the eyelet, turn the «Upper Multi-function Knob» or the «Lower Multi-function Knob».
- > Sew the Eyelet Program.
 - The machine stops automatically at the end of the Eyelet Program.
- > Use an awl, punch pliers or a hole punch to open the eyelet.



10 Quilting

10.1 Overview Quilt Stitches



Stitch Pattern	Stitch Number	Name	Description
	No. 1301	Quilting, Securing Program	To secure at the sewing start and sewing end with short stitches forward.
	No. 1302	Quilting, Straight stitch	For machine quilting using a straight stitch with a 3 mm stitch length.
	No. 1303	Piecing stitch/Straight stitch	For sewing patchwork parts together using a straight stitch with a 2 mm stitch length.
	No. 1304 – No. 1308	Hand-look Quilt Stitch	For attaching an imitation of hand-look stitch with monofilament.
	No. 1309 – No. 1314	Blanket Stitch	For appliqués and sewing on ribbons.

10.2 Quilting, Securing Program

Prerequisite:

- The Reverse Pattern Foot #1 is fitted.

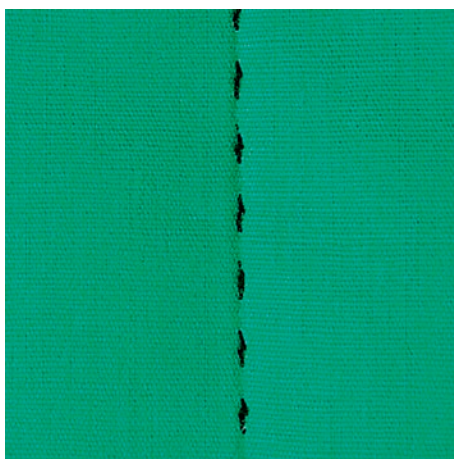


- > Tap «Quilt Stitches».
- > Select Quilting, Securing Program No. 1301.
- > Press the foot control.
 - The machine sews 6 short stitches forwards automatically when sewing is started.



- > Sew the seam at the desired length.
- > Push the button «Quick Reverse».
 - The machine sews 6 short stitches forwards automatically and stops automatically at the end of the Securing Program.

10.3 Sewing Handlook Quilt Stitches



Hand-look quilt stitches are suitable for all fabrics and sewing projects that should look like hand-sewn. It is recommended to use a monofilament thread as upper thread and an embroidery thread as bobbin thread. The sewing speed should be moderate to prevent the monofilament from breaking. If required, the upper thread tension and the balance can be adjusted to the sewing project and the desired quilt stitch.

Prerequisite:

- The Reverse Pattern Foot #1 is fitted.



- > Tap «Quilt Stitches».
- > Select Hand-look Quilt Stitch No. 1304 or No. 1305, No. 1306, No. 1307 or No. 1308.
- > If necessary, adjust the upper thread tension and the Balance to suit the sewing project and the desired quilt stitch.
- > To start the machine, press the foot control or push the button «Start/Stop».

10.4 Guiding the Quilt Work Freely



Freehand quilting and darning use the same principle of free movement. With stipple quilting, entire surfaces of the fabric are filled with quilt stitches. The single lines of stitching are rounded and never cross one another.



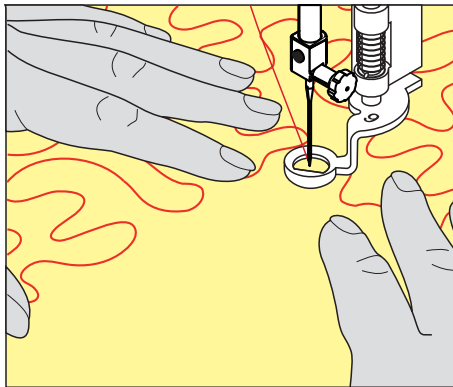
- Quilting gloves with rubber nubs make it easier to guide the fabric.
- For the best possible results use the High Thread Tension Bobbin Case (optional accessory).
- It is recommended to use the slide-on table and the Free Hand System.
- With free motion quilting, it is of advantage to quilt from the center outwards and to guide the fabric using smooth, round movements to form the design of your choice.

Prerequisite:

- The top layer, the batting and the backing are pinned together or basted.
- The feed dog is lowered.
- The Darning Foot #9 is fitted.



- > Tap «Practical Stitches».
- > Select Straight Stitch No. 1.
- > If required, adjust the upper thread tension.
- > To prevent the fabric from shifting, select the needle position down.
- > To start the machine, press the foot control or push the button «Start/Stop».
- > Hold both hands close to the presser foot like an embroidery hoop to guide the fabric. Make sure that the needle does not pierce the same place several times in a row.
- > To ensure a minimum stitch distance when quilting corners, reduce the embroidery speed.
- > If the thread is lying on top of the fabric, slow down the movement.
- > If there are knots on the wrong side of the fabric, move the fabric more quickly.



11 Care and Maintenance

11.1 Firmware

Verifying the Software Version



> Tap «Home».



> Tap «Setup Program».



> Tap «Machine Settings».



> Tap «Information».



> Tap «Machine Data».
– The current version of the machine software will be displayed.

Updating Firmware

Backing up Personal Data and Settings

In general, personal data and settings are automatically transferred during a software update.

However, in order to prevent a potential loss of data, we recommend backing up personal data and settings on a BERNINA USB stick before a firmware update. This means they can be transferred back onto the machine in the case of irregularities.

Downloading an Update

You can download the latest firmware version from www.bernina.com and set it up according to the firmware update installation instructions, which you can likewise find on the website.

Perform Firmware Update

Prerequisite:

- The latest firmware version is loaded onto a USB stick in accordance with the firmware update installation instructions (see www.bernina.com).

> Insert the USB stick with the new firmware version into the machine's USB port.



> Tap «Home».



> Tap «Setup Program».



> Tap «Machine Settings».



> Tap «Maintenance/update».



> Tap «Updating firmware».



NOTICE**Incomplete update because the BERNINA USB stick was removed too soon**

If the software has not been updated or has not been fully updated, the machine cannot be used.

- > Remove the BERNINA USB stick only once the update has been successfully completed.

Update

- > To start the firmware update, tap «Update».
 - Wait until the firmware update has finished.

Restoring Saved Data

If personal data and settings are not available after a software update, they can be transferred to the machine again afterwards.

- > Insert the USB stick with the saved data and settings into the USB port of the machine.
- > Tap «Home».



- > Tap «Setup Program».



- > Tap «Machine Settings».



- > Tap «Maintenance/update».



- > Tap «Updating firmware».



- > Tap «Load Data».
- > Wait until the data has been fully transferred.

NOTICE**BERNINA USB Stick (Optional Accessory) has been removed too early**

Saved data cannot be transferred and the machine cannot be used.

- > Remove the BERNINA USB stick (optional accessory) only after the saved data has been transferred successfully.

- > Remove the USB stick.

11.2 Machine**Cleaning the Display**

- > Clean the display when it is switched off with a soft slightly damp microfiber cloth.

Cleaning the Feed Dog

Remaining threads under the stitch plate must occasionally be removed.

- > Raise the needle and presser foot.

CAUTION**Electronically Driven Components**

Risk of injury near the needle and the hook.

- > Switch the machine off and disconnect it from the power supply system.

- > Remove the needle and presser foot.

- > Lower feed dog.



- > Remove the stitch plate.

NOTICE

Dust and Thread Residues Inside the Machine

Damage to mechanical and electronic components.

- > Use a brush or a soft cloth.
- > Do not use compressed air spray.

- > Clean the feed dog with the brush.

Cleaning the Hook

CAUTION

Electronically Driven Components

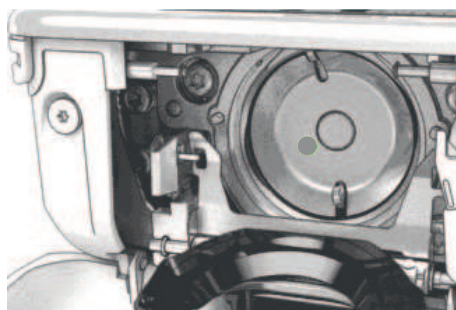
Risk of injury near the needle and the hook.

- > Switch the machine off and disconnect it from the power supply system.

- > Open the hook cover.
- > Remove the bobbin case.
- > Push the release lever to the left.



- > Flap down the locking bracket with the black hook race cover.
- > Remove the hook.



NOTICE

Dust and Thread Residues Inside the Machine

Damage to mechanical and electronic components.

- > Use a brush or a soft cloth.
- > Do not use compressed air spray.

- > Clean the hook race area with a brush and a soft cloth. Never use any sharp instruments.



- > Hold the hook at the pin in the center with two fingers.
- > Bring the hook diagonally from top to bottom behind the hook race cover with the lower edge first.
- > Position the hook so that the two lugs on the hook driver fit into the corresponding openings on the hook, and the colored marking on the hook driver is visible in the hole of the hook.
- > Insert the hook.
 - The hook is magnetic and therefore fastened to the correct position.
- > Close the hook race cover and the fastening bracket until the release bracket engages.
- > As a check, turn the handwheel.
- > Insert the bobbin case.

Lubricating the hook

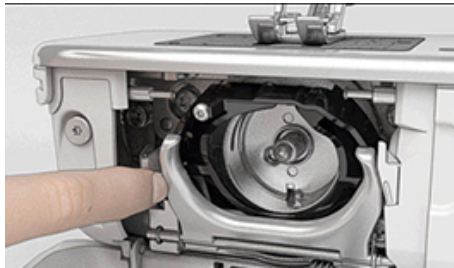
CAUTION

Electronically Driven Components

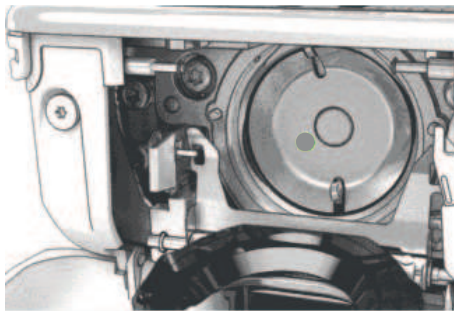
Risk of injury near the needle and the hook.

- > Switch the machine off and disconnect it from the power supply system.

- > Remove the bobbin case.
- > Push the release lever to the left.



- > Flap down the locking bracket with the black hook race cover.
- > Remove the hook.



NOTICE

Lubricating the hook

Too much oil can pollute the fabric and the thread.

- > After lubricating, sew/embroider a test piece first.
- > Add one drop of BERNINA oil down into the hook race.



- > Add one drop of oil into each of the two oil depots so that the felts are damp, and make sure that the red-marked surface of the hook sleeve remains free of oil.

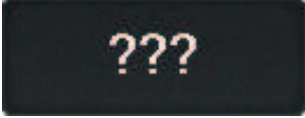
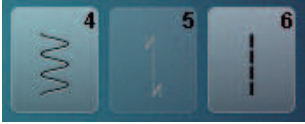







- > Hold the hook at the pin in the center with two fingers.
- > Bring the hook diagonally from top to bottom behind the hook race cover with the lower edge first.
- > Position the hook so that the two lugs on the hook driver fit into the corresponding openings on the hook, and the colored marking on the hook driver is visible in the hole of the hook.
- > Insert the hook.
 - The hook is magnetic and therefore fastened to the correct position.
- > Close the hook race cover and the fastening bracket until the release bracket engages.
- > As a check, turn the handwheel.
- > Insert the bobbin case.




12 Errors and Faults

12.1 Error Messages



Message on the Screen	Cause	Solution
	Stitch number unknown.	> Check the entry and enter the new number.
	Selection of these stitch patterns not possible in Combi-mode.	> Combine other stitch patterns.
	The feed dog is not lowered.	> Press the button «Feed Dog Up/Down» to lower the feed dog.
	The selected needle and stitch plate cannot be used in combination.	> Replace the needle. > Replace the stitch plate.
	The needle is not at its top end.	> Adjust the needle position via the handwheel.
	The main motor is not running.	> Turn the handwheel clockwise until the needle is at its top position. > Remove the stitch plate. > Remove the thread remnants. > Clean the hook. > Remove the hook and make sure that there are no pieces of broken needle points on the magnetic back of the hook. > Insert the hook correctly.
Too little free capacity on the BERNINA USB stick (optional accessory).	Not enough free space on the USB stick.	> Delete data from the USB stick.
No personal data on the BERNINA USB stick (optional accessory).	No personal data for recovery available on the USB stick.	> Make sure that the data and settings have been saved on the USB stick.
The recovery of personal data has failed.	The firmware update has been successful but the personal data could not be recovered.	> Make sure that the data and settings have been saved on the USB stick. > Transfer saved data to the machine.

Message on the Screen	Cause	Solution
No BERNINA USB stick is inserted. Make sure that the same BERNINA USB stick remains connected during the entire automatic update process.	USB stick is not inserted.	<ul style="list-style-type: none"> > Use a BERNINA USB stick with enough free memory.
The firmware update has failed.	The latest firmware version cannot be found on the USB stick.	<ul style="list-style-type: none"> > Make sure that the compressed zip file has been unzipped for the firmware update. > Check whether the data for the software update is saved directly on the data medium and not in a file on the USB stick. > Updating Firmware.
	The machine must be cleaned/ lubricated.	<ul style="list-style-type: none"> > Clean the machine. > Lubricate the hook. <p>Important Information on Lubricating: Too much oil may stain the fabric and the thread.</p> <ul style="list-style-type: none"> > After lubricating, always embroider on a test piece.
It is time for the regular maintenance. Please contact your authorized BERNINA dealer to make an appointment.	<p>The machine needs maintenance. The message appears after the programmed service interval has expired.</p> <p>Important Information: Having your machine cleaned and serviced properly at the appropriate times ensures its proper functioning and a long service life. In case of noncompliance, the service life may be negatively affected, and the warranty service may possibly become limited. The cost allocation for maintenance work is regulated nationally. Consult your authorized BERNINA dealer or your service center for more details.</p>	<ul style="list-style-type: none"> > Contact your BERNINA dealer. > Delete the message temporarily by touching the icon «ESC». <p>After the third deletion, the message is not displayed until the next service interval is reached.</p>

Message on the Screen	Cause	Solution
	The calibration of the Buttonhole Foot with Slide #3A has failed.	<ul style="list-style-type: none"> > Check the presser foot for ease of movement. If necessary, remove lint, dust and fabric remnants. > Clean the reflector with a soft, slightly damp microfiber cloth. > Check the position of the reflector. If necessary, correct the position of the reflector or replace the presser foot. > Check the plastic on the underside of the presser foot for signs of wear. If necessary, replace the presser foot. > Clean the feed dog. > Contact your BERNINA dealer.
#1000	The needle threader is jammed.	<ul style="list-style-type: none"> > Switch off the machine. Press the needle threader down and release it again. Switch the machine on. > If the error still occurs, contact your BERNINA dealer.
#1002	The button «Needle position Up/ Down» is stuck or defective.	<ul style="list-style-type: none"> > Make sure that the button can be operated without restriction. > If the error still occurs, contact your BERNINA dealer.
#1003	The button «Start/Stop» is stuck or defective.	<ul style="list-style-type: none"> > Make sure that the button can be operated without restriction. > If the error still occurs, contact your BERNINA dealer.
#1004 #1005 #1010	The exact cause of the malfunction cannot be determined.	<ul style="list-style-type: none"> > Restart the machine. > If the error still occurs, contact your BERNINA dealer.

12.2 Troubleshooting

Fault	Cause	Solution
Uneven Stitch Formation	Upper thread too tight or too loose.	<ul style="list-style-type: none"> > Adjust the upper thread tension. > Check the thread feed from the thread spool.
	Needle blunt or bent.	> Replace the needle, make sure that a new BERNINA quality needle is used.
	Poor quality needle.	> Use a new BERNINA quality needle.
	Poor quality thread.	> Use quality thread.
	Incorrect needle/thread combination.	> Match the needle with the thread size.
	Incorrectly threaded.	> Rethread.
	Fabric was pulled.	> Feed the fabric evenly.

Fault	Cause	Solution
<p>Uneven Stitch Formation</p> 	<p>Incorrect bobbin case is used.</p>	<p>> Use the supplied bobbin case marked with the triangle.</p>
<p>Skipped Stitches</p>	<p>Incorrect needle.</p> <hr/> <p>Needle blunt or bent.</p> <hr/> <p>Poor quality needle.</p> <hr/> <p>The needle is incorrectly inserted.</p> <hr/> <p>Incorrect needle point.</p>	<p>> Use the needle system 130/705H.</p> <hr/> <p>> Replace the needle.</p> <hr/> <p>> Use a new BERNINA quality needle.</p> <hr/> <p>> Insert the needle with the flat side to the back as far up as it will go into the needle holder and tighten the screw.</p> <hr/> <p>> Match the needle point to the texture of the material.</p>
<p>Faulty Stitching</p>	<p>Thread remnants between the thread tension discs.</p> <hr/> <p>Incorrectly threaded.</p> <hr/> <p>Thread remnants below the bobbin case spring.</p>	<p>> Fold a piece of thin material and slide the folded edge (not the raw edges) between the thread tension discs.</p> <hr/> <p>> Rethread.</p> <hr/> <p>> Remove the thread remnants under the spring.</p>
<p>Upper Thread Breaks</p>	<p>Incorrect needle/thread combination.</p> <hr/> <p>Upper thread is too tight.</p> <hr/> <p>Incorrectly threaded.</p> <hr/> <p>Poor quality thread.</p> <hr/> <p>The stitch plate or the hook tip is damaged.</p> <hr/> <p>The thread is caught in the area of the thread take-up lever.</p> 	<p>> Match the needle with the thread size.</p> <hr/> <p>> Reduce the upper thread tension.</p> <hr/> <p>> Rethread.</p> <hr/> <p>> Use quality thread.</p> <hr/> <p>> Contact your authorized BERNINA dealer to have the damages repaired.</p> <p>> Replace the stitch plate.</p> <hr/> <p>> Slide the headframe (1) to the left, then remove it.</p> <p>> Remove the thread remnants.</p> <p>> Insert the 4 knobs of the headframe into the provided notches and slide the headframe to the right.</p>

Fault	Cause	Solution
Lower Thread Breaks	The bobbin case is damaged.	> Replace the bobbin case.
	The stitch hole in the stitch plate is damaged.	> Contact your authorized BERNINA dealer to have the damages repaired. > Replace the stitch plate.
	Needle blunt or bent.	> Replace the needle.
Needle Breaks	The needle is incorrectly inserted.	> Insert the needle with the flat side to the back as far up as it will go into the needle holder and tighten the screw.
	Fabric was pulled.	> Feed the fabric evenly.
	Thick fabric has been pushed.	> Use a suitable presser foot, e. g. Jeans Foot #8, for thick fabric. > Use the height compensating tool when sewing over a thick seam.
	Knotted thread.	> Use quality thread.
Stitch Width Not Adjustable	The selected needle and stitch plate cannot be used in combination.	> Replace the needle. > Replace the stitch plate.
Speed Too Low	Unfavorable room temperature.	> Place the machine in a warm room one hour before use.
	Settings in the Setup Program.	> Adjust the sewing speed in the Setup Program. > Adjust the slide.
The Machine doesn't Start	Unfavorable room temperature.	> Place the machine in a warm room one hour before use. > Connect the machine and switch it on.
	The machine is damaged.	> Contact your authorized BERNINA dealer.
Error during Firmware Update	USB stick is not recognized.	> Prepare the USB stick according to the update instructions. > Use the BERNINA USB stick (optional accessory).
	The update process is blocked and the hourglass on the display is inactive.	> Remove the USB stick. > Switch off the machine. > Switch the machine on. > Follow the instruction on the display.
	Firmware update files are not found.	> Unzip the update data. > Store data for the firmware update directly on the data medium and not in a folder on the USB stick.
BSR Presser Foot #42 not detected	Lens is dirty.	> Clean the lens with a soft, slightly damp cloth.
	BSR cable not inserted correctly.	> Insert the BSR connector vertically until it can be felt to click into place.

Fault	Cause	Solution
Beads and/or Bartacks are repeatedly not sewn properly	The Buttonhole Foot with Slide #3A is not calibrated with the machine.	> Calibrate Buttonhole Foot with Slide #3A. (see page 47)

13 Storage and Disposal

13.1 Storing the Machine

BERNINA recommends that you store the machine in its original packaging. If the machine is stored in a cold room, place the machine in a warm room for one hour before use.

- > Switch the machine off and disconnect it from the power supply system.
- > Don't store the machine outdoors.
- > Protect the machine against climatic influences.

13.2 Dispose of the Machine

- > Clean the machine.
- > Sort the components by their materials and dispose of them according to the local laws and regulations.

14 Technical Data

Article	Value	Unit
Maximum fabric thickness	10.5 (0.41)	mm (inch)
Sewing Light	8	LED
Maximum speed	900	spm/rpm
Measurements without the spool pin	423 × 330 × 200 (18.30 × 12.99 × 7.87)	mm (inch)
Weight	9.5 (20.94)	kg (lb)
Energy consumption	90	Watts
Input voltage	100 – 240	Volts
Protection class (Electrical Engineering)	II	
Production date: Can be seen on the type label under «Code».		

15 Overview Stitch Patterns

15.1 Overview Stitch Patterns

Practical Stitches

1 	2 	3 	4 	5 	6 	7 	8 	9 	10 	11 	12 	13 	14
15 	16 	17 	18 	19 	20 	22 	23 	24 	25 	26 	29 	30 	32
33 													

Buttonholes

51 	52 	53 	54 	56 	59 	60 	61 	62 	63
--------	--------	--------	--------	--------	--------	--------	--------	--------	--------

Decorative Stitches

Nature Stitches

101 	102 	103 	104 	106 	107 	108 	109 	110 	111 	112 	113 	114 	115
116 	117 	118 	119 	122 	123 	124 	125 	136 	137 				

Cross Stitches

301 	302 	303 	304 	305 	306 	307 	308 	309 	311 	312
---------	---------	---------	---------	---------	---------	---------	---------	---------	---------	---------

Satin Stitches

401 	402 	405 	406 	407 	408 	409 	410 	412 	413 	414 	415 	416 	417
425 	426 	429 	465 	466 									

Geometric Stitches

601	602	603	604	605	606	607	608	609	610	611	612	613	614
615	616	651	652	653	654	655	656	657					

Heirloom Stitches

701	702	703	704	705	706	707	708	709	710	711	712	713	714
715	716	717	721	722	723	724	725	726	727	729	730	731	732
741	742	743											

Children Stitches

901	902	903	904	905	906	907	908	909	910	911	912	913	914
915	916	917	918	919	920	921	922	924	935	948	950	954	961

Quilt Stitches

1301	1302	1303	1304	1305	1306	1307	1308	1309	1310	1311	1312	1313	1314
.....	-----	-----	-----	6 / Inch 2.4 / cm	8 / Inch 3.2 / cm	10 / Inch 4 / cm	irregular look	┌┐┌	┌┌┌	┌┌┌	┌┌┌	┌┌┌	┌┌┌

Index

A

Activate/Deactivate Functions.....	21
Adjusting Pressure Foot Position via Knee Lifter.....	32
Adjusting the Maximum Sewing Speed.....	44
Adjusting the Screen Brightness.....	45
Adjusting the Upper Thread Tension.....	44
Alphabets.....	78
Attaching the Knee Lifter of the Free Hand System.....	29

B

Buttonholes.....	80
------------------	----

C

Calibrating the Buttonhole Foot with Slide #3A.....	47
Calling Up the Creative Consultant.....	49
Calling Up the Help.....	49
Calling up the Tutorial.....	49
Changing the Needle.....	34
Changing the Presser Foot.....	33
Changing the Presser Foot Sole.....	32
Changing the Stitch Plate.....	36
Child Safety Lock.....	49
Cleaning the Feed Dog.....	95
Cleaning the Hook.....	96
Combination Mode.....	53
Cord.....	83
Customizing Values.....	22

D

Decorative Stitches.....	73
Dispose of the Machine.....	105

E

Energy-saving Mode.....	49
Entering Dealer Data.....	46
Environmental Protection.....	9
Error Messages.....	99
Explanation of Symbols.....	10

F

Firmware	
Activate/Deactivate Functions.....	21
Customizing Values.....	22
Navigation.....	21
Updating.....	94

Foot Control	
Connecting.....	28

I

Inserting the Spool Cap.....	31
------------------------------	----

L

Lubricating the Hook.....	97
---------------------------	----

M

Maintenance and Cleaning.....	95
-------------------------------	----

N

Navigation.....	21
Needle Stop Up/Down (Permanent).....	36
Needle, Thread, Fabric.....	23
Needle/Thread Combination.....	27
Needles Overview.....	23

P

Pintucks.....	75
Power Cable.....	28
USA/Canada.....	28
Practical Stitches.....	59

Q

Quilting.....	91
---------------	----

R

Recovering Data.....	95
Regulating the Speed.....	50
Restoring the Default Settings.....	47

S

Safety Instructions.....	7
Saving a Stitch Pattern Combination.....	54
Saving the Service Data.....	46
Select Personal Settings.....	44
Selecting a Language.....	45
Selecting a Stitch Pattern.....	50
Setting the Sounds.....	45
Sewing a Test Sample.....	84
Slide-on Table.....	31
Software Version.....	94
Storing the machine.....	105

T

Technical Specifications.....	106
Threading the Bobbin Thread.....	41
Threading the Triple Needle	40
Threading the Twin Needle	39
Threading the Upper Thread	37
Troubleshooting.....	101

U

Using eco Mode.....	49
Using the Spool Net.....	31

W

Winding the Bobbin Thread	40
---------------------------------	----



BERNINA recommends threads from *Mettler*[®]

BERNINA International AG | CH-8266 Steckborn Switzerland | www.bernina.com | © Copyright by BERNINA International AG

made to create **BERNINA**