

BERNINA[®] 1008

Electronic



Instruction Manual

Instruction Manual



IMPORTANT SAFETY INSTRUCTIONS

When using an electrical appliance, basic safety precautions should always be followed, including the following:

Read all instructions before using this sewing machine.

DANGER

To reduce the risk of electric shock:

1. An appliance should never be left unattended when plugged in.
2. Always unplug this appliance from the electric outlet immediately after using and before cleaning.
3. Always unplug before relamping. Replace bulb with same type rated 15 watts.

WARNING

To reduce the risk of burns, fire, electric shock, or injury to persons:

1. Do not allow to be used as a toy. Close attention is necessary when this appliance is used by or near children.
2. Use this appliance only for its intended use as described in this manual. Use only attachments recommended by the manufacturer as contained in this manual.
3. Never operate this appliance if it has a damaged cord or plug, if it is not working properly, if it has been dropped or damaged, or dropped into water. Return the appliance to the nearest authorized dealer or service center for examination, repair, electrical or mechanical adjustment.
4. Never operate the appliance with any air openings blocked. Keep ventilation openings of the sewing machine and foot controller free from accumulation of lint, dust, and loose cloth.
5. Keep fingers away from all moving parts. Special care is required around the sewing machine needle.
6. Always use the proper needle plate. The wrong plate can cause the needle to break.
7. Do not use bent needles.
8. Do not pull or push fabric while stitching. It may deflect the needle causing it to break.
9. Switch the sewing machine off when making any adjustments in the needle area, such as threading needle, changing bobbin, or changing presser foot, and the like.
10. Always unplug sewing machine from the electrical outlet when removing covers, lubricating, or when making any other user servicing adjustments mentioned in the instruction manual.
11. Never drop or insert any object into any opening.
12. Do not use outdoors.
13. Do not operate where aerosol (spray) products are being used or where oxygen is being administered.
14. To disconnect, turn all controls to the off position, then remove plug from outlet.
15. Do not unplug by pulling on cord. To unplug, grasp the plug, not the cord.

SAVE THESE INSTRUCTIONS

This sewing machine is intended for household use only.

Setting up the sewing machine 1

Presser feet 13
Practical stitches
Practical sewing

Troubleshooting 29
Maintenance

Index



Dear BERNINA Customer

Congratulations on choosing a BERNINA 1008. You are now the proud owner of a sewing machine which fulfils every expectation in terms of use and quality. You own a first class product which will give you sewing pleasure for many years to come.

Some hundred years ago, my great grandfather invented the first ever hemstitch machine. This was the beginning of the BERNINA family business and I am proud to be the fourth generation member of the family to have responsibility for the company. I am delighted to welcome you to the millions of satisfied BERNINA owners around the world.

If you require any further information about your sewing machine or sewing in general, please do not hesitate to contact your BERNINA dealer, who will be delighted to help you.

I wish you very happy and successful sewing.

Yours truly,

Hanspeter Ueltschi
President

BERNINA®

Display/Control panel

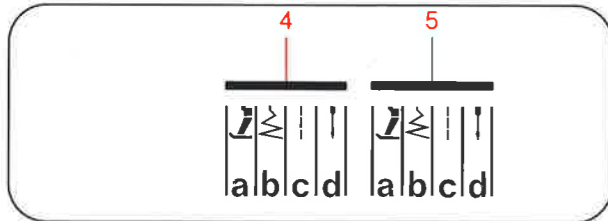
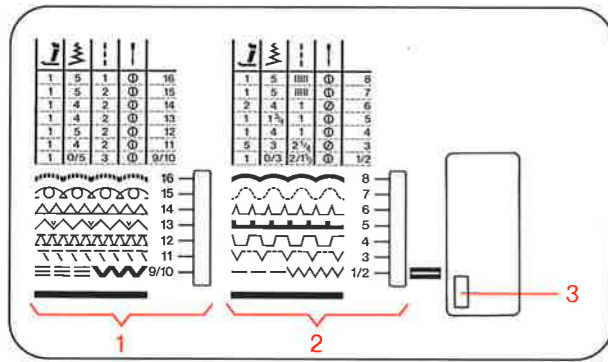

- 1 Red stitch programme
- 2 Green stitch programme
- 3 Selector lever
- 4 Basic setting panel, red stitches
 - a. Presser foot
 - b. Stitch width
 - c. Stitch length
 - d. Needle position
- 5 Basic setting panel, green stitches
 - a. Presser foot
 - b. Stitch width
 - c. Stitch length
 - d. Needle position
- 6 Stitch width knob
- 7 Needle position knob
- 8 Buttonhole knob
- 9 Stitch length knob
- 10 RED - GREEN stitch programme selector knob
- 11 Feed-dog knob

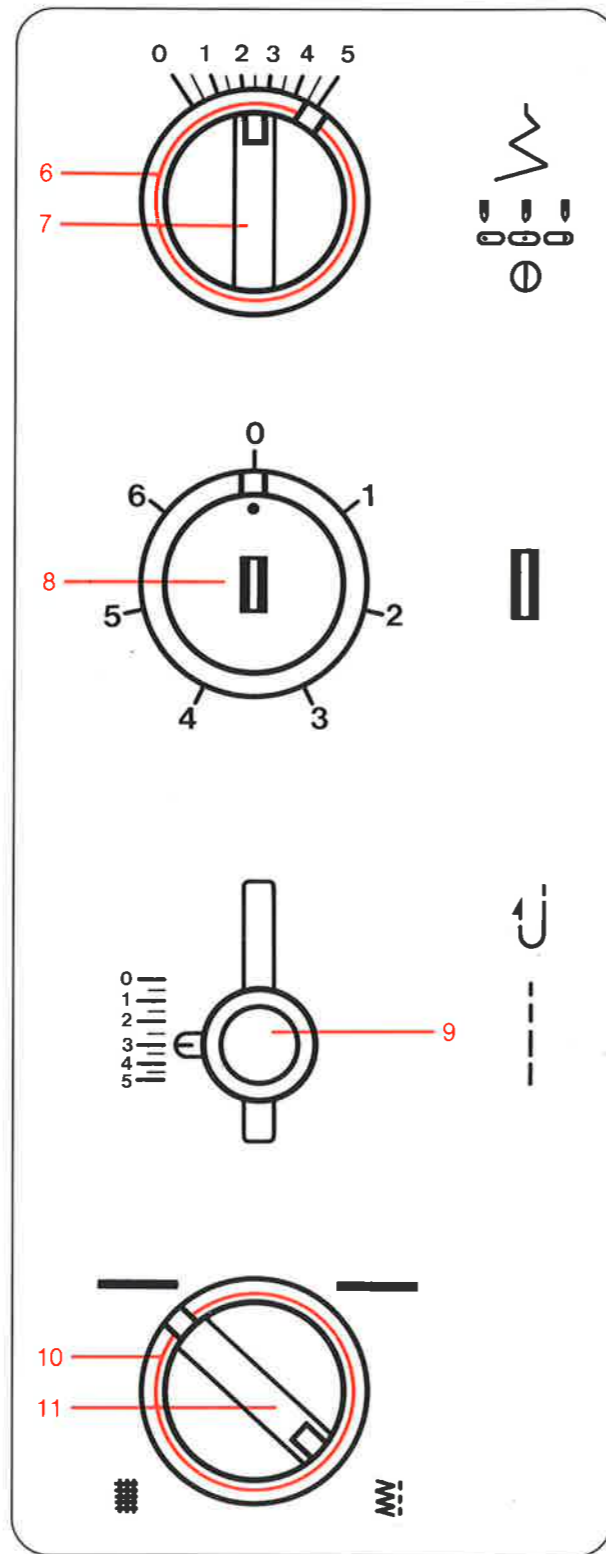

Details of machine

- 1 Hinged front cover
- 2 Stitch plate
- 3 Presser foot
- 4 Needle clamp
- 5 Thread regulator
- 6 Thread take-up lever
- 7 Pre-tension stud
- 8 Thread tension slot
- 9 Thread tension adjustment knob
- 10 Red stitches
- 11 Green stitches
- 12 Selector lever
- 13 Bobbin spindle
- 14 Bobbin winder stop
- 15 Handwheel
- 16 Stitch width knob
- 17 Needle position knob
- 18 Buttonhole knob
- 19 Power/light switch
- 20 Stitch length knob
- 21 Securing pins for sewing table
- 22 Stitch programme color indicator (RED - GREEN)
- 23 Combined mains/foot control socket
- 24 Stitch programme selector knob
- 25 Sewing/Darning selector knob
- 26 Presser foot lever
- 27 Carrying handle
- 28 Thread guide
- 29 Thread holder pins
- 30 Supplementary thread guide
- 31 Thread cutter





Setting up the sewing machine

Cover, accessories



Cover, accessories

The cover protects the machine from dust and dirt.

The outside pocket provides storage for the instruction manual, foot control and cable.

The machine is very easy to carry with the practical, retractable handle.

Standard accessories

- accessories box
- 4 bobbins
- needle pack
- seam ripper
- small screwdriver
- screwdriver
- bulb holder
- brush
- oiler
- presser foot shaft for snap-on soles
- reverse pattern sole
- overlock sole
- blind stitch sole
- buttonhole sole
- zip sole

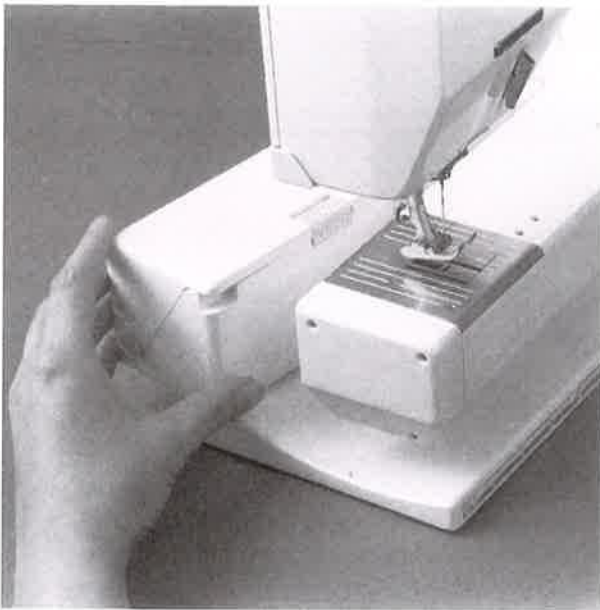

Removing the accessories box

Simply push the accessories box backwards.

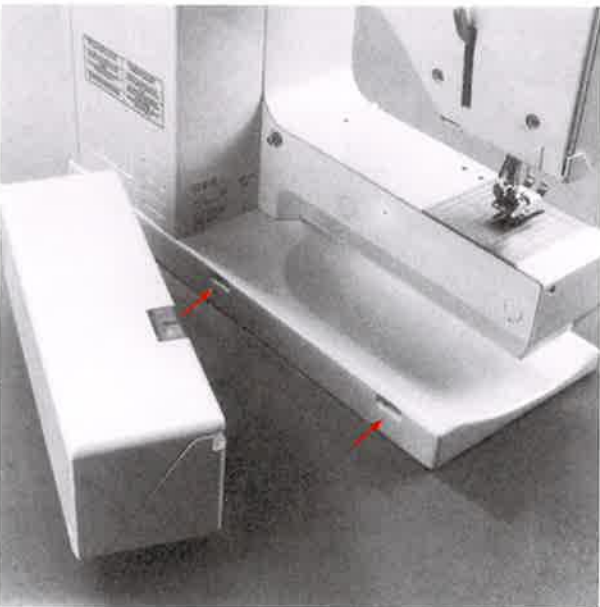

Fitting the accessories box onto the machine

The accessories box has two fixing lugs that fit into the base plate of the machine.

Lay the accessories box onto the base plate from the rear and press against the free arm until the fixing lugs engage in the holes provided.

Mains cable, foot control unit, sewing light, power switch

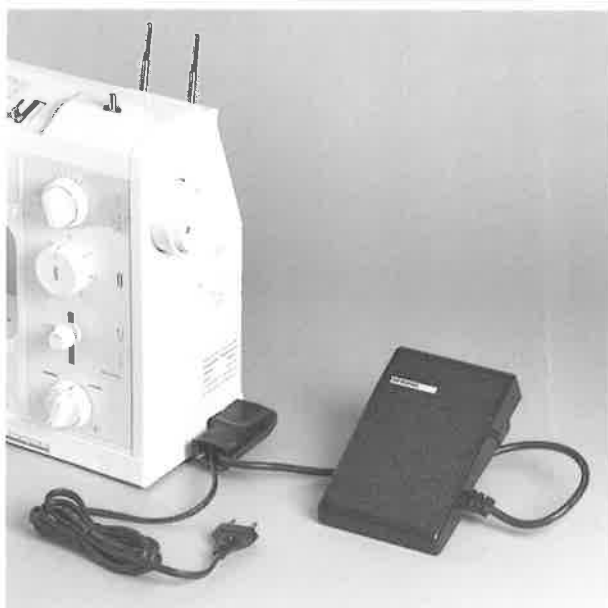

Connecting mains cable and foot control unit

Plug the specially combined mains/foot control cable into the machine. Plug the cable into the mains socket.

WARNING: (USA/Canada only)

This sewing machine has a polarized plug (one blade wider than the other). To reduce the risk of electric shock, this plug is intended to fit in a polarized outlet only one way. If the plug does not fit fully in the outlet, reverse the plug. If it still does not fit, contact a qualified electrician to install the proper outlet. Do not modify the plug in any way.

Foot control unit

This is used to regulate the sewing speed.

The sewing speed can be controlled from virtually 0 to maximum speed by varying the pressure on the plate of the foot control unit.

USA/Canada only

Use only foot controller Type YC-420-6A with sewing machine model 1008.



Machines with foot controls type YC-423A

High frequency power surges can cause fluctuations in motor speed of up to 20%. These disappear as soon as normal power resumes.

Power switch sewing light

The power switch below the handwheel has 3 positions:

0 **Off** The machine is switched off.

1 **On** The machine is switched on.

1  The machine and sewing light are switched on.

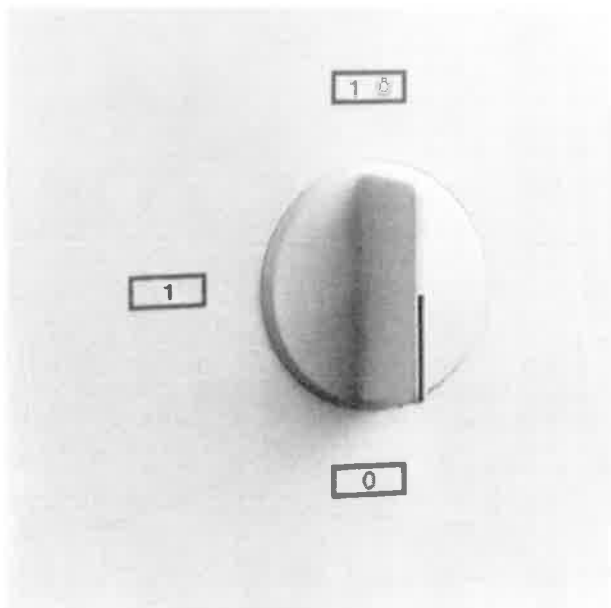

Bobbin case and bobbin, winding lower thread

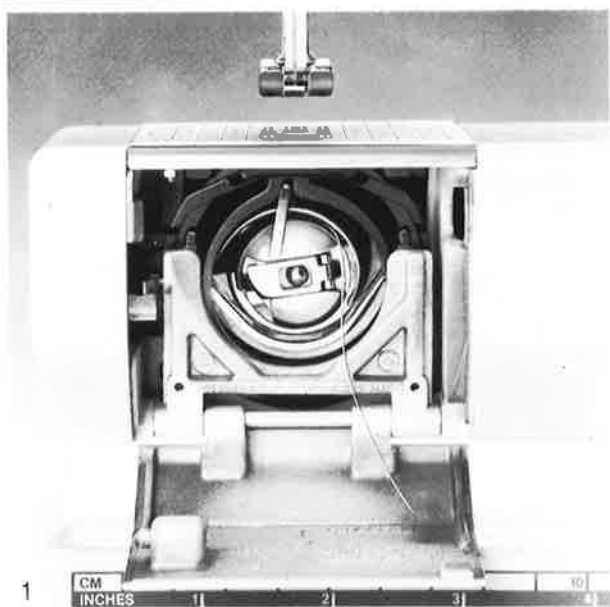

Removing the bobbin case

Set the power switch to the 0 position.

Check that the needle is raised. Open the hinged front cover on the free arm (Fig. 1).

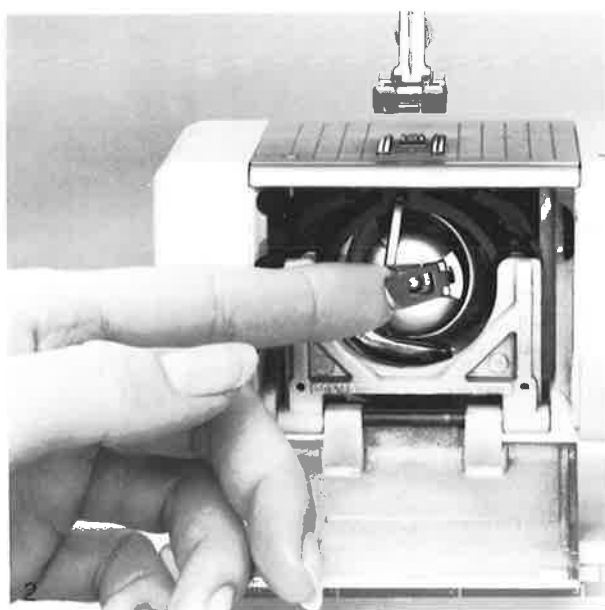

With the index finger and thumb of the left hand, pull the bobbin case latch forward and remove the bobbin case (Fig. 2).



Winding lower thread

Holding the handwheel with the left hand, turn the handwheel release forward with the right hand. The sewing machine is now disengaged (Fig. 3). Place empty bobbin on the spindle and press it to the right against the bobbin winder stop. The bobbin winder is now engaged.

Take thread from the reel of thread on the thread holder pin and pass it clockwise around the pre-tension stud to the empty bobbin. Wind around the empty bobbin several times, again in a clockwise direction (Fig. 4).

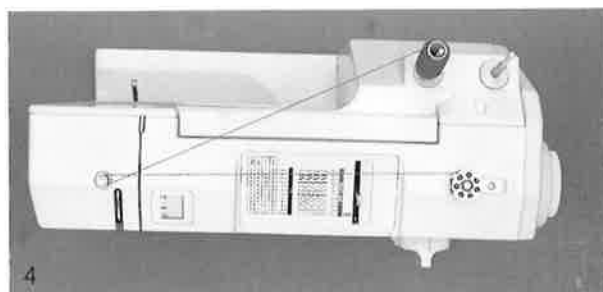

Press on the foot control to start the motor. When the bobbin is full, the bobbin winder will stop automatically. Push bobbin to left and remove.

WARNING:

Please refer to the safety instructions.

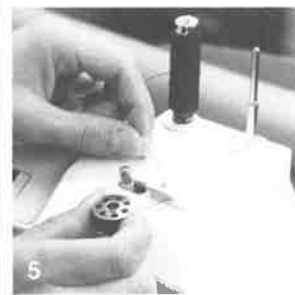

When removing the bobbin, cut the thread by pulling it to the left against the bobbin winder stop (Fig. 5).

Inserting the bobbin



Inserting the bobbin

Hold the bobbin case in the left hand.
Insert the bobbin with the thread running in a clockwise direction, see arrow.

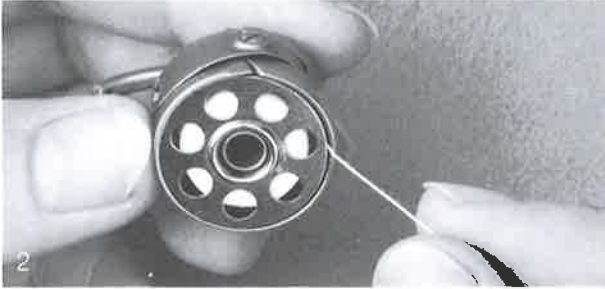

Take the thread anticlockwise to the slot.



Pull the thread into the slot and under the spring, until it lies in the T-shaped slot at the end of the spring.



When the end of the thread is pulled, the bobbin should turn clockwise, in the direction of the arrow.

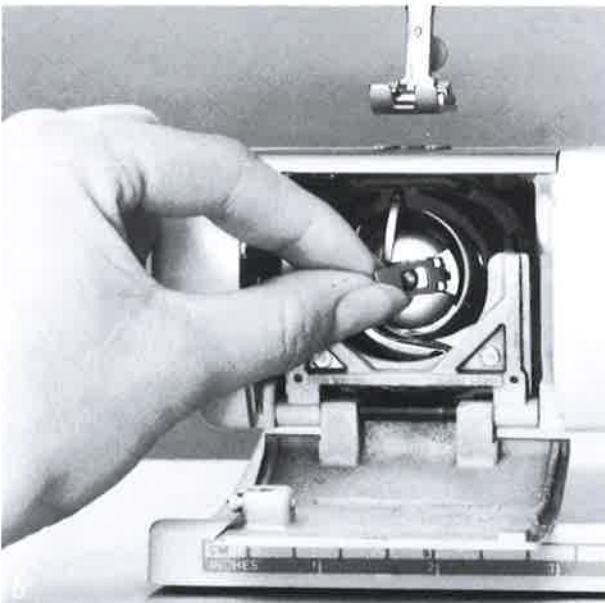

Inserting the bobbin case into the hook

Hold the bobbin case by the latch with the index finger and thumb of the left hand. Insert so that the finger of the bobbin case points upwards, engaging in the notch of the hook race cover.
Check: Pull end of thread. Close the hinged front cover.

Threading the upper thread

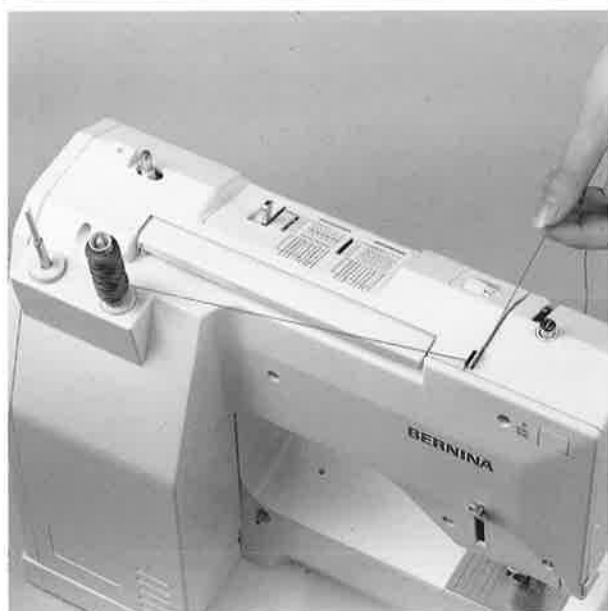

Thread the upper thread

Check that the needle is in the raised position. Raise the presser foot.

Place the reel of thread on one of the two thread holder pins.

Firmly clip the thread into the thread guide on the top of the machine. Then pull it through the long slot (A) into the thread tension.

WARNING:

Please refer to the safety instructions.

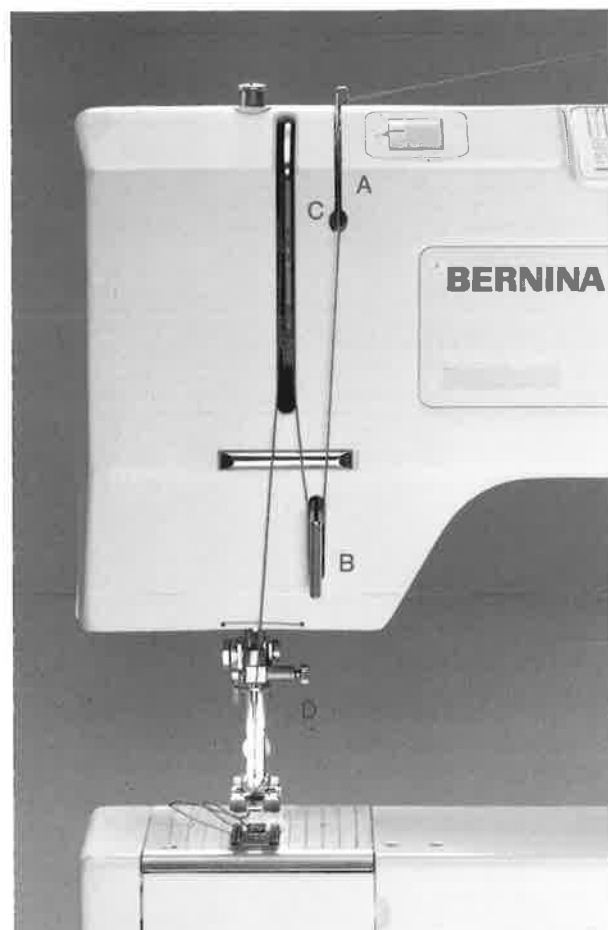

On the front of the machine, take the thread from the slot (A) downwards under the thread regulator (B), then up to the thread take-up lever at the top (C) and down again to the needle holder thread guide (D).

Always thread the needle from front to back.

The small white plate on the front of the presser foot shank helps when threading the needle eye. Pull the thread approx. 10 cm (4") through the needle eye.

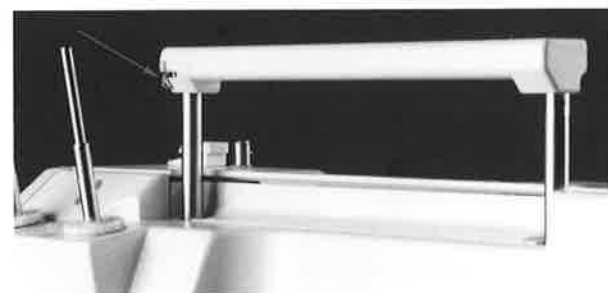

Supplementary thread guide on handle

Sewing with cross-wound reels, metal and silver thread, double or triple needles.

For perfect thread feed, take the thread through the special supplementary thread guide on the handle.

Bringing up the lower thread, thread tension, feed-dog



▲ 1

Bringing up the lower thread

Hold the upper thread loosely. Turn the handwheel towards you until the thread take-up lever is fully raised. Pull the upper thread so that the lower thread is brought up through the stitch plate hole (Fig. 1). Take both threads through the slot in the presser foot and place to the side. Instead of using the needle stop, the lower thread can also be brought up by turning the handwheel forward until the needle returns to its highest position. In this case the upper thread has to be held with the left hand.

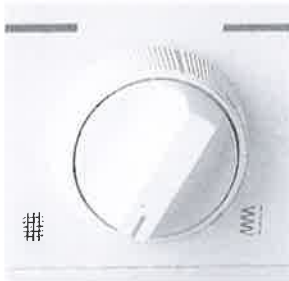

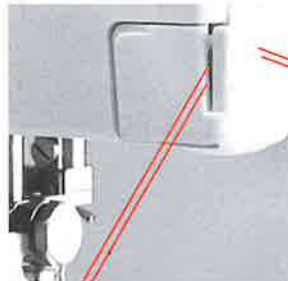

▲ 2



▲ 3

Lowering the feed-dog

For certain types of sewing, eg. for darning, the fabric must not be moved by the feed-dog. Therefore the feed-dog must be lowered, by turning the knob to the left until the mark points to the symbol  (Fig. 2). For normal sewing, the knob should face the symbol .



▼ 5

▲ 4

Thread cutter

To remove your work, raise the presser foot, take the work out to the rear left and hook both threads into the cutter. The threads ends remain secure until sewing is continued (Fig. 3).

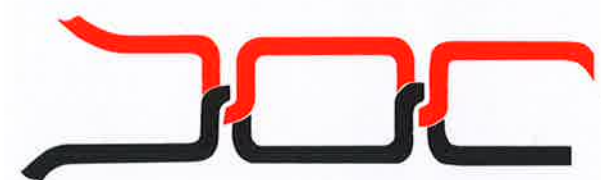

▼ 6

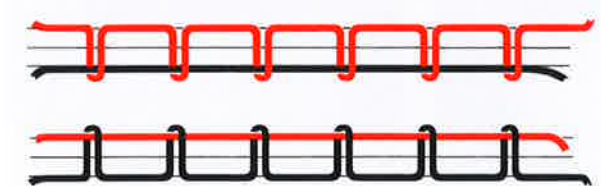

▲ 7

Thread tension

One of the main advantages of BERNINA machines is that there is very rarely any need to alter the thread tension for normal sewing. For the normal tension setting, the red mark on the tension regulating dial should match the adjacent mark on the machine (Fig. 4). For special sewing, the thread tension can be adjusted with the aid of the regulating dial. Turning the tension regulating dial forwards, to number 4 or below, gives a looser upper thread tension. Turning the tension regulating dial backwards, to number 6 or above, gives a tighter upper thread tension. When the tension is **correctly** set, the upper and lower threads form loops between the two layers of fabric (Fig. 5). **Incorrect** upper thread tension will produce knots, loose loops or thread breakage. If tension is too loose knots will form on the underside (Fig. 6). If tension is too tight knots will form on the upper side (Fig. 7).

Important!
The thread tension should be reset to normal when the special sewing has been completed.

Inserting the needle changing presser feet

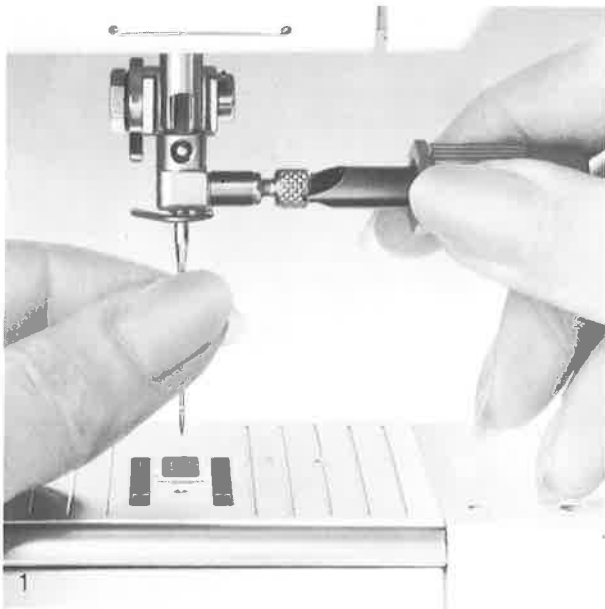

Inserting the needle

The small black screwdriver for loosening or tightening the needle clamp is provided in the accessories box.

Set the power switch to

0.

Check that the needle is in the raised position. If not, turn the handwheel.

Loosen the needle clamp screw by half a turn (anti-clockwise) and remove the needle (Fig. 1).

Insert a NEW needle – flat side to the rear.

Insert the needle until it reaches the **top**. If the needle is not inserted fully, i.e. is set too low, skipped stitches will result.

Tighten the needle clamp screw securely.

WARNING:

Please refer to the safety instructions.

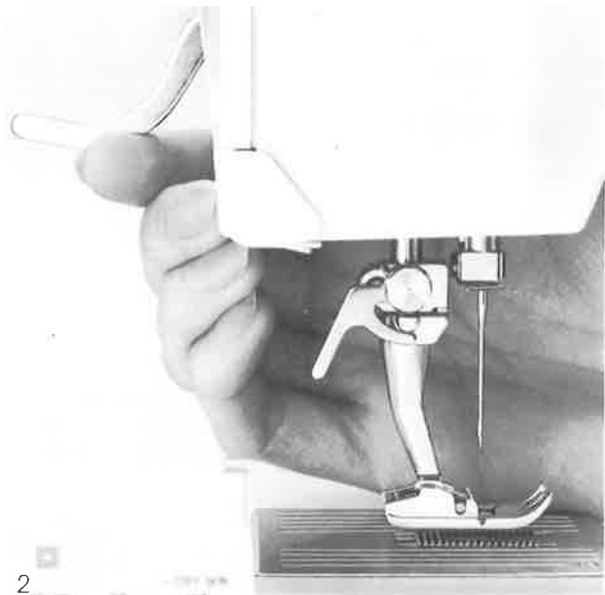

Changing the presser foot shaft

Successful sewing results depend on the correct choice of presser foot. Changing the presser foot shaft and sole is quick and easy:

Raise the needle.

Raise the presser foot shaft.

Raise the clamping lever with the index finger of your right hand and remove the presser foot shaft with your middle finger and thumb (Fig. 3).

Attaching the presser foot shaft: Follow the same procedure but press the

clamping lever down with your index finger.

Changing the presser foot sole

Raise the needle and presser foot. Turn power switch to 0 and press the button on the shaft to release the sole (Fig. 4).

Attaching the presser foot sole

Place the sole under the shaft so that the pin lies under the opening on the shaft. Lower the presser foot lifter and the sole engages (Fig. 5).

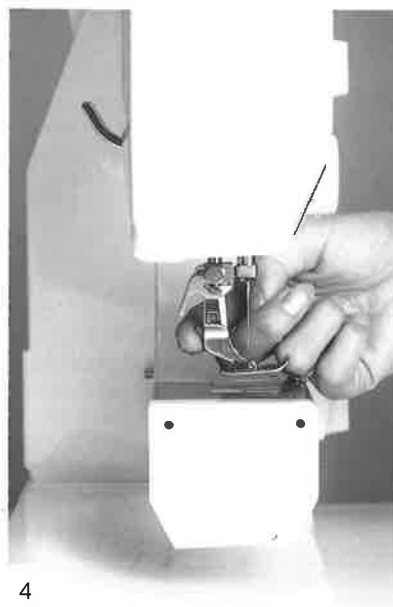
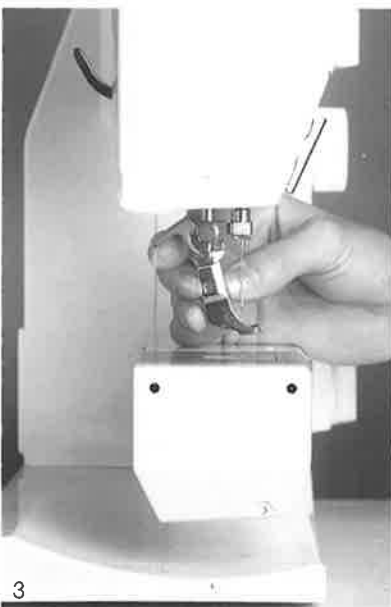

Sewing tips



A few hints

Set your BERNINA far enough away from the table edge. Correct sitting position and correct guiding of the work will make sewing easier. Sit right in front of the needle, i.e. in front of the working area. This will enable you to watch the working area without strain. Ensure that the height of your chair allows you to work comfortably.

It is best to guide the work from the side with the fingers of the left hand close to the presser foot. When sewing delicate work, it is preferable to stop and guide it a little at a time rather than let the work slide beneath the fingers.

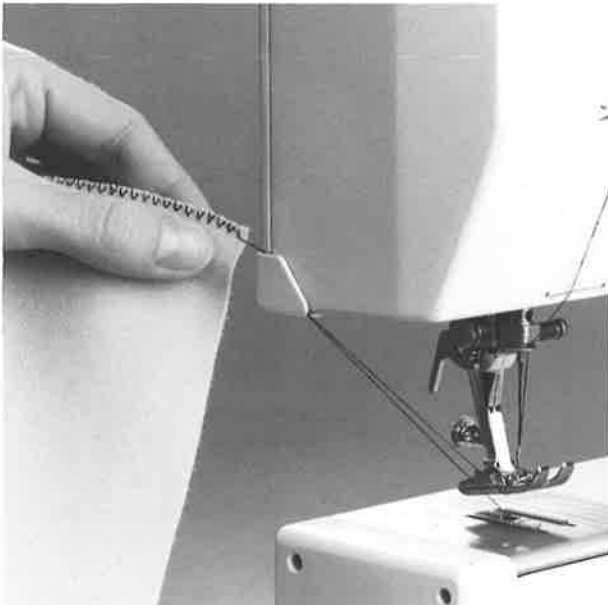

To remove the work, raise the presser foot and check that the needle is raised. If not, turn the handwheel. Take work out to the rear left and hook both threads into the cutter. The thread ends free themselves when you start sewing again.

Needle and sewing machine

Your BERNINA has needle system 130/705 H. Make sure when buying new needles that they are the 130/705 H system. Commercially available needle sizes are nos. 70 to 120. The finer the needle, the lower the number. The opposite applies to thread. The finer the thread, the higher the number.

Needle and thread

The needle size required depends on the thread selected. The needle must match the thread. When sewing, the thread lies in the long groove to the front of the needle (Fig. 1). If the needle is too fine, the thread will not fit into the groove (Fig. 2) and skipped stitches will result.

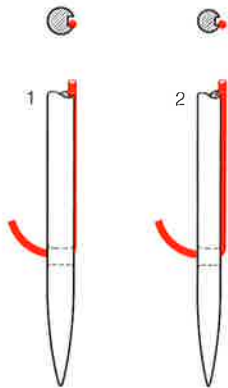

Needle and fabric Condition of needle

The needle must be in perfect condition. Sewing problems are caused by:
A. bent needles
B. blunt needles
C. hooked tips

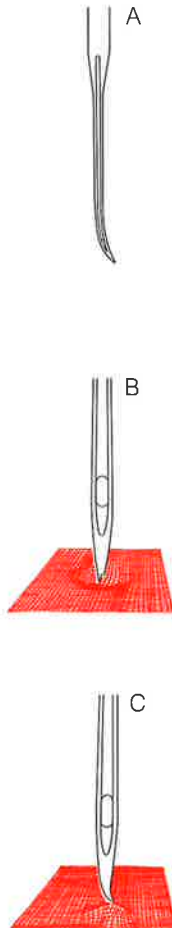

Standard needles

130/705 H
Normal point, slightly rounded

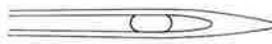

All-purpose needle for woven synthetic and natural fibres, fine linen, chiffon, batiste, organdie, wool, velvet, decorative seams and embroidery.

Special needles

130/705 SES
Fine ball point



Fine knits, also specially suitable for synthetics.

130/705 H-SUK
Medium ball point



Heavier synthetic or natural fibre knits.

130/705 H-Stretch
Medium ball-point



Special needle for delicate or difficult stretch fabrics.

130/705 H-J
Extra fine point

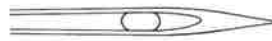

Twill, workwear, heavy linen, denim, canvas. Penetrates dense fabrics more easily.

130/705 H-LL or H-LR
Cutting point

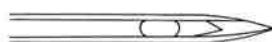

Leather, suede, calfskin, kid, pigskin, imitation leathers and suedes, plastics, waxed fabrics.

Needle/Thread Table

Needle	70	80	90	100	110-120
Darning thread	*	*			
Embroidery thread 30		*			
Mercerised cotton sewing thread		*	*		
Synthetic sewing thread		*	*		
Coarse mercerised cotton Mercerised synthetic			*	*	
Buttonhole thread for top stitching (Cordonnet)				*	*

This table shows clearly which needle suits which thread.

Fabric feed and height compensation

1. Fabric feed and stitch length

With each stitch the feed-dog moves forward by one step. The length of this step is governed by the stitch length selected. With an extremely short stitch length, the steps are also short. The fabric moves under the foot quite slowly, even at full sewing speed. Buttonholes, satin stitch and decorative stitches are all sewn with a short stitch length.

Important:

- a) Make sure that the fabric feeds evenly.

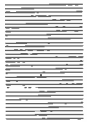

- b) Pushing will result in gaps.



- c) Holding back will result in pile-ups.



2. Fabric feed and height compensation

The height compensating plates guarantee perfect fabric feed when sewing thick areas and topstitching edges. One, two or three compensating plates can be used depending on the thickness (height).

- a) The feed-dog can only work properly when the presser foot is flat.



- b) When sewing thick areas, the presser foot is forced upwards which does not allow the feed-dog to grip and feed the fabric correctly.

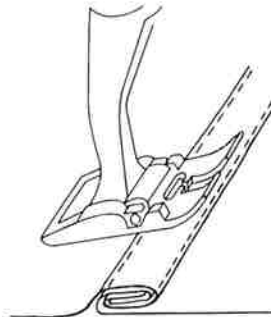

- c) To compensate for the height (thickness), place one, two or three compensating plates behind the needle under the presser foot.

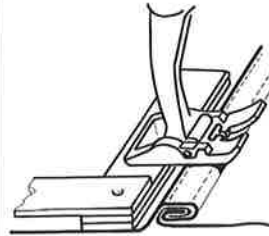

- d) To compensate in front of the presser foot, place one or more plates to the right of the foot flush with the needle. Sew over the thick area and then remove the plates.

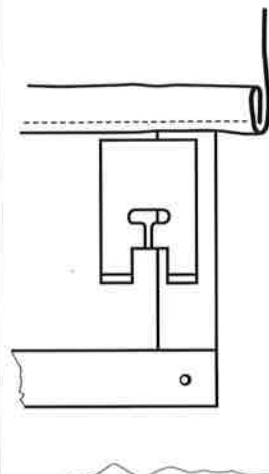

3. Fabric feed and sewing corners

- a) The two rows of teeth of the feed-dog are quite a distance apart because of the width of the zig-zag needle hole.



- b) When sewing corners, only a small part of the fabric is actually on the feed-dog so it cannot feed the work correctly.

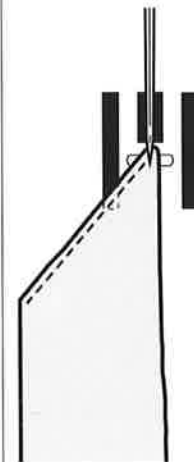

- c) For an even feed, place one or more plates to the right of the presser foot flush with the fabric edge.

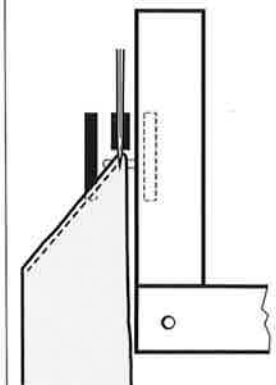



Presser feet
Practical stitches
Practical sewing

Presser feet

Presser feet are an important sewing aid. They are designed with grooves and guides. Successful sewing depends on the correct choice of presser foot.

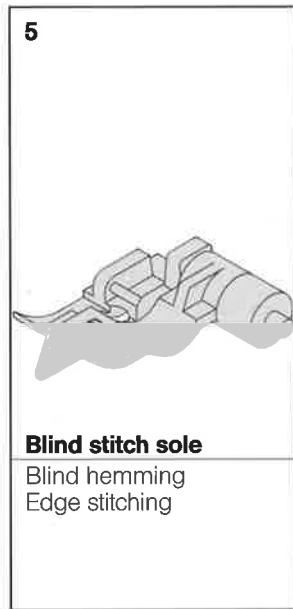
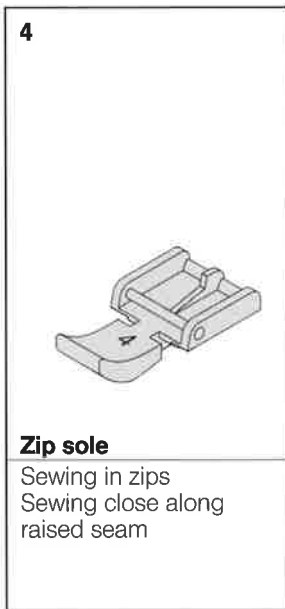
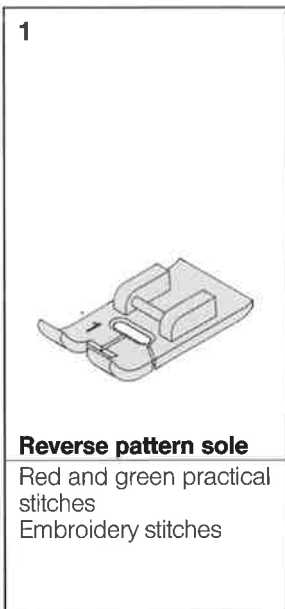









Note:

The **presser foot shaft** and **snap-on soles** are standard accessories with the BERNINA 1008.

Presser feet available as **special accessories** from your BERNINA dealer are illustrated in the instruction manual.







Range of applications

Green practical stitches

<p>1 Straight stitch</p>  <p>Alle types of non-stretch fabric.</p> <p>All straight stitch work.</p>	<p>2 Zig-zag</p>  <p>For most types of fabric.</p> <p>All simple zig-zag work, e.g. over-sewing, especially on fine fabrics. Sewing elastic and lace.</p>	<p>3 Blind stitch</p>  <p>For most types of fabric.</p> <p>Blind hemming, shell edging on soft jersey and fine fabrics, decorative work.</p>	<p>4 Universal stitch</p>  <p>For firmer knitted fabrics, felt, leather etc.</p> <p>Flat joining seams, visible hems, patchwork, mending interlock fabrics, sewing on elastic, decorative seams.</p>
<p>5 Stretch stitch</p>  <p>For very stretchy fabrics.</p> <p>Very stretchy open seams for ski, riding, climbing and hiking wear.</p>	<p>6 Vari-overlock</p>  <p>Primarily for fine synthetic and silk jersey, Helanca, fine cotton and wool jerseys.</p> <p>Stretchy overlock seams and hems, particularly suitable for sports underwear, T-shirts, sweatshirts, etc.</p>	<p>7 Running stitch</p>  <p>For most types of fabric.</p> <p>Darning with running stitch, mending of woven fabric, reinforcing edges, etc.</p>	<p>8 Scallop stitch</p>  <p>Primarily for woven fabrics.</p> <p>Edging of tablecloths, place mats, collars, cuffs, etc.</p>

Range of applications

Red practical stitches Red decorative stitches

<p>9 Triple straight stitch</p>  <p>For corduroy, denim, overall and deck-chair fabrics, carpet borders, rucksacks, sleeping bags and similar.</p> <p>Hard-wearing seam for joining pieces of fabric or top stitching seams.</p>	<p>10 Triple zig-zag</p>  <p>For denims, corduroys, leathers, decorative hems, light fabrics for blinds and similar.</p> <p>Visible hems and seams, sewing on tape, extra strong seam for sportswear, woollen blankets, sleeping bags, rucksacks.</p>	<p>11 Towelling stitch</p>  <p>Primarily for towelling fabrics, denim, leather and other firm fabrics.</p> <p>Flat joining seams, visible hems for beachwear, craft work.</p>	<p>12 Double overlock</p>  <p>For all types of knitted fabrics and hand and machine knitted articles.</p> <p>Overlock seam.</p>
<p>13 Edge stitch</p>  <p>For most types of fabric.</p> <p>Visible hems, sewing on lace and tapes of all kinds, decorative edges, craft work.</p>	<p>14 Reinforced overlock stitch</p>  <p>For sweatshirt fabric, towelling, medium-weight knits.</p> <p>Reinforced overlock seams, craft work.</p>	<p>15/16 Decorative stitches</p>  <p>15</p> <p>16</p>	

Straight stitch

Needle positions

1	5	1	⊕	16	1	5		⊕	8
1	5	2	⊕	15	1	5		⊕	7
1	4	2	⊕	14	2	4	1	⊕	6
1	4	2	⊕	13	1	1 3/4	1	⊕	5
1	5	2	⊕	12	1	4	1	⊕	4
1	4	2	⊕	11	5	3	2 1/4	⊕	3
1	0/5	3	⊕	9/10	1	0/3	2 1/4	⊕	1/2

Presser foot:	1
Thread:	according to fabric
Needle:	according to thread
Stitch:	
Stitch width:	0
Stitch length:	1-5 according to fabric
Needle position:	centre
Feed-dog:	sewing
Colour indicator:	

Forward sewing
The machine sews forwards with the settings specified and with the selected stitch length. The stitch length is selected according to the type of sewing and fabric.

Reverse sewing
Push the stitch length knob upwards above 0 and hold until reverse sewing is completed. When the knob is released again, the machine will again sew forwards with the previously selected stitch.

Securing ends
At the beginning and end of a seam, sew in reverse for approx. 1 cm (3/8") and then forwards again.

Securing thick seams
When changing from forward to reverse sewing and vice-versa, stop the machine. The needle should be raised. If not, turn the handwheel forwards. This prevents the needle from being bent by thick fabrics.

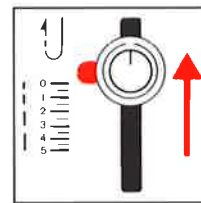

Stitch width

Needle position

Buttonhole

Stitch length
Normal stitch length is approx. 2

Colour indicator

Feed-dog

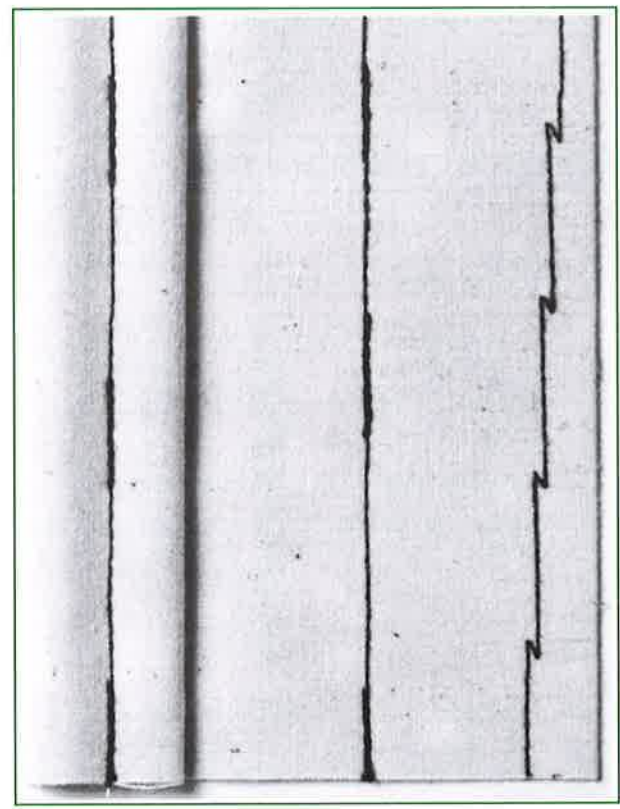

Five needle positions

The position of the stitch can be set to left and right in five positions with the needle position knob.

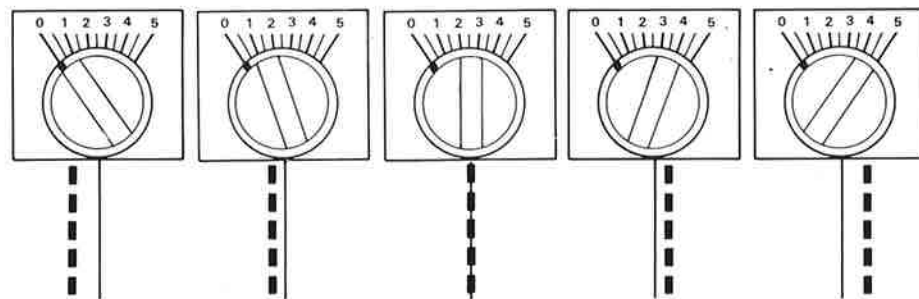



For normal sewing, the needle is in the centre.

- Examples of use:**
- Blind hemming Page 24
 - Edge stitching Page 25
 - Sewing in zips Page 20

Zig-zag

Satin stitch

Setting zig-zag

Presser foot:	1
Thread:	according to fabric
Needle:	according to thread
Stitch:	
Stitch width:	1-5
Stitch length:	1-5
Needle position:	centre
Feed-dog:	sewing
Colour indicator:	

Setting zig-zag width and length

The stitch width and length can be altered during sewing or while the machine is stopped.

Set the width of the zig-zag stitch with the stitch width knob. It is infinitely variable up to 5 mm.

The needle must not be left in the work when the machine is stopped.

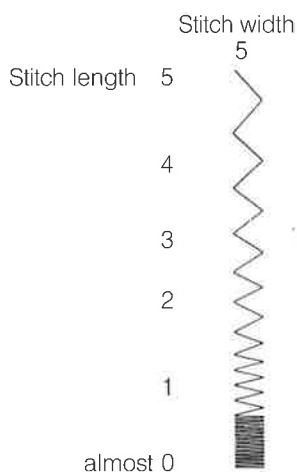

Satin stitch = close zig-zag = IIIII

Presser foot:	1 (6*)
Thread:	embroidery thread No. 30
Needle:	80
Stitch width:	1½-5
Stitch length:	IIIII (satin stitch density)

* Additional accessory

Set stitch length to very close zig-zag = IIIII

Turn stitch length knob to the right until it locks.

The mark on the knob is at the top. Stitch length is now 0.

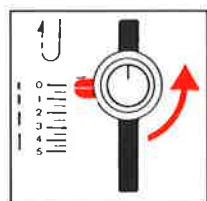

By rotating half a turn to the left (mark at the bottom) the basic setting for satin stitch is obtained = IIIII.

Adjust the stitch density according to the work. Turn anti-clockwise for thicker fabric, clockwise for finer fabric.

Oversewing edges

Presser foot:	1
Thread:	darning or sewing thread
Needle:	80-70
Stitch width:	2½-5 (according to fabric)
Stitch length:	1-3 (according to fabric)

Generally, the zig-zag should not be too wide or the stitch length too long. Start by cutting a neat edge. Use as fine a thread as possible, especially on fine fabrics.

Guide the edge of the fabric to the centre of the foot so that the needle goes alternately into the fabric and then over the edge.

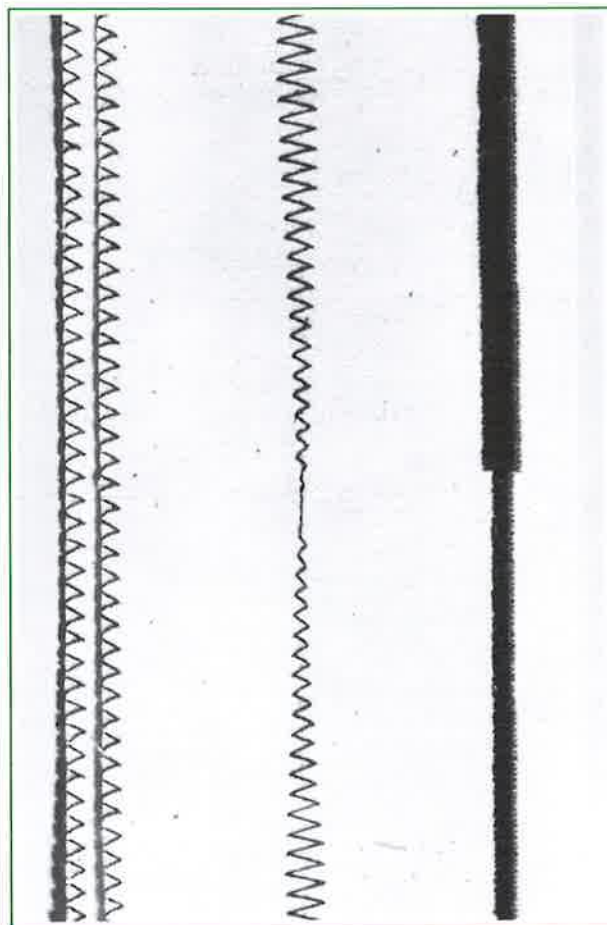
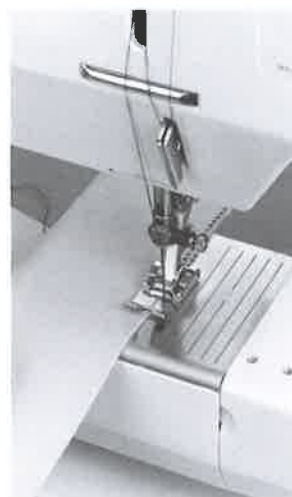

Selecting green stitches

1	5	1	⊙	16	
1	5	2	⊙	15	
1	4	2	⊙	14	
1	4	2	⊙	13	
1	5	2	⊙	12	
1	4	2	⊙	11	
1	0/5	3	⊙	9/10	

	a	b	c	d	
1	5		⊙	8	
1	5		⊙	7	
2	4	1	⊙	6	
1	1 3/4	1	⊙	5	
1	4	1	⊙	4	
5	3	2 1/4	⊙	3	
1	0/3	2 1/2	⊙	1/2	

- a Presser foot
- b Stitch width
- c Stitch length
- d Needle position

Push the selector lever to the right to disengage and select a stitch from 1–8.

Set the colour indicator to **green**.

The number for the basic setting is the same as the number of the stitch selected.

Each stitch has many different applications. The stitch width and length can be adjusted to the type of work and fabric.

The presser foot display recommends the appropriate foot for easy work and perfect results.

Universal stitch

Presser foot:	1
Stitch:	
Stitch width:	4
Stitch length:	1
Needle position:	centre
Feed-dog:	sewing
Colour indicator:	

Blind stitch

Presser foot:	5
Stitch:	
Stitch width:	3
Stitch length:	2 1/4
Needle position:	right
Feed-dog:	sewing
Colour indicator:	

Vari-overlock

Presser foot:	2
Stitch:	
Stitch width:	4
Stitch length:	1
Needle position:	right
Feed-dog:	sewing
Colour indicator:	

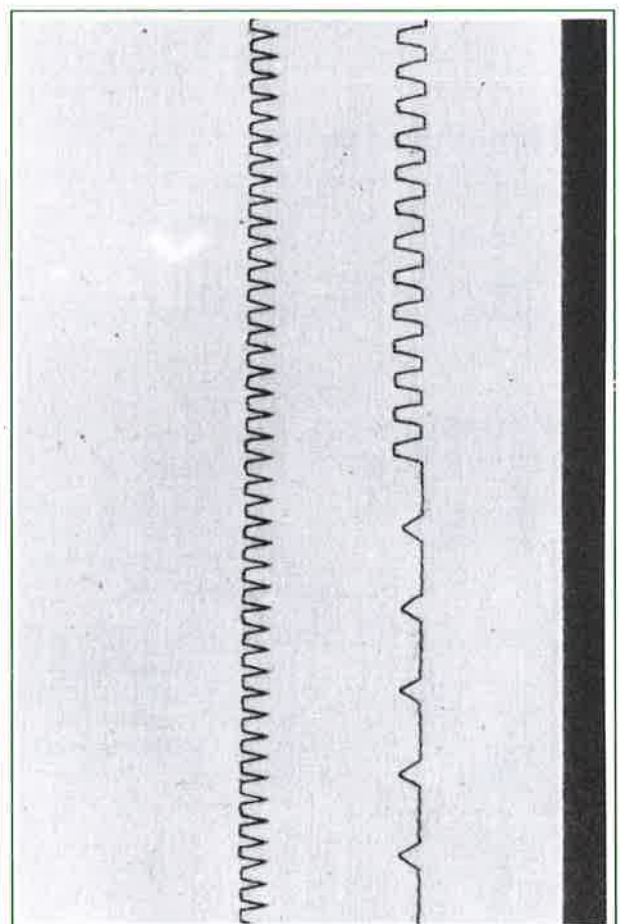

Selecting red stitches

a	b	c	d	
1	5	1	⊙	16
1	5	2	⊙	15
1	4	2	⊙	14
1	4	2	⊙	13
1	5	2	⊙	12
1	4	2	⊙	11
1	0/5	3	⊙	9/10

1	5		⊙	8
1	5		⊙	7
2	4	1	⊙	6
1	1 3/4	1	⊙	5
1	4	1	⊙	4
5	3	2 1/4	⊙	3
1	0/3	2 1/4	⊙	1/2

- a Presser foot
- b Stitch width
- c Stitch length
- d Needle position

Push the selector lever to the right to disengage and select a stitch from 9–16.

Set the colour indicator to red.

The number for the basic setting is the same as the number of the stitch selected.

Each stitch has many different applications. The stitch width and length can be adjusted to the type of work and fabric.

The presser foot display recommends the appropriate foot for easy work and perfect results.

Triple zig-zag

Presser foot:	1
Stitch:	
Stitch width:	5
Stitch length:	3
Needle position:	centre
Feed-dog:	sewing
Colour indicator:	

Towelling stitch

Presser foot:	1
Stitch:	
Stitch width:	4
Stitch length:	2
Needle position:	centre
Feed-dog:	sewing
Colour indicator:	

Double overlock

Presser foot:	1
Stitch:	
Stitch width:	5
Stitch length:	2
Needle position:	centre
Feed-dog:	sewing
Colour indicator:	

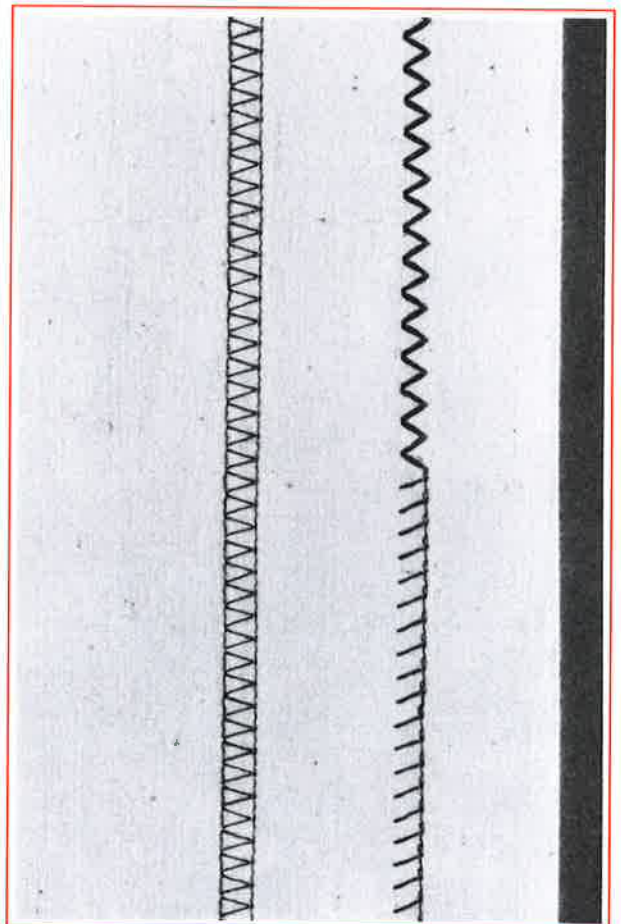

Blind hemming

Presser foot:	5
Thread:	sewing/darning thread
Needle:	80-70
Stitch:	
Stitch width:	approx. 3
Stitch length:	2¼
Needle position:	right/half right
Feed-dog:	sewing
Colour indicator:	

Sewing table/special accessory

Important

As with hand sewing, fine fabrics require a fine needle and fine thread.

Preparation

The hem should be prepared in the same way as for sewing by hand. Oversew raw edge, baste and press.

Positioning the hem

The hem is positioned under the foot as shown in Fig. 1.

Sewing test

(Either on a remnant of fabric or directly on the hem.)

Given the variations in fabric thickness, it is advisable to sew a test piece first. As when sewing by hand, the needle should only catch the fold of the fabric. Because of these variations, a slight adjustment may be necessary.

If stitches are visible from the right, adjust the guide on the presser foot with the screw.

Sew slowly until the needle swings to the left. Using the handwheel, bring the needle down until it is just about to enter the fabric and check that it is only just catching the fabric. If necessary, adjust the stitch width slightly.

Narrower if the needle is going in too far and a little wider if it is failing to catch sufficiently.

Check the next zig-zag stitch in the same way.

Then sew for approximately 10 cm (4") and check again.

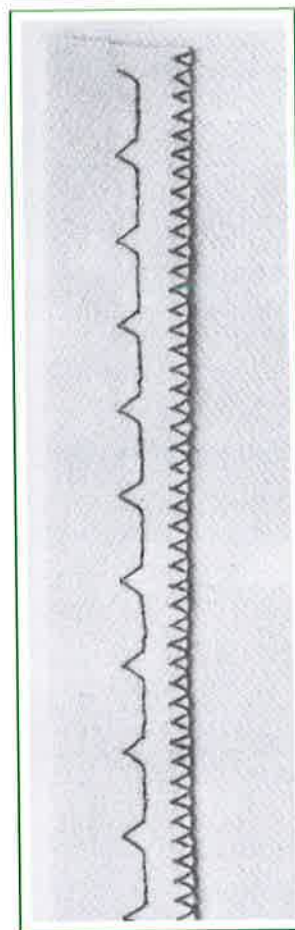
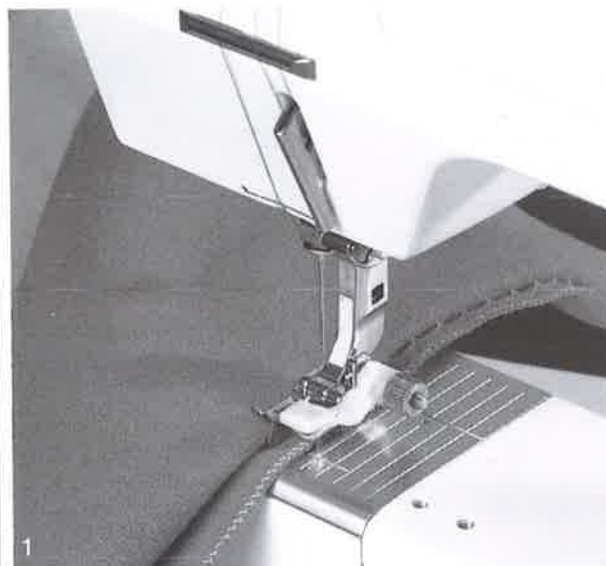

Edge stitching using the needle positions

Edge stitching on collars, cuffs, lapels, hems, etc.

Presser foot:	5
Thread:	sewing thread
Needle:	80
Stitch:	-----
Stitch width:	0
Stitch length:	2-5 (as required)
Needle position:	left/half left
Feed-dog:	sewing
Colour indicator:	

Sewing table/additional accessory

Place the edge of the fabric from the left against the guide of the Blind stitch foot (Fig. 1). Set the needle position to left or half left.

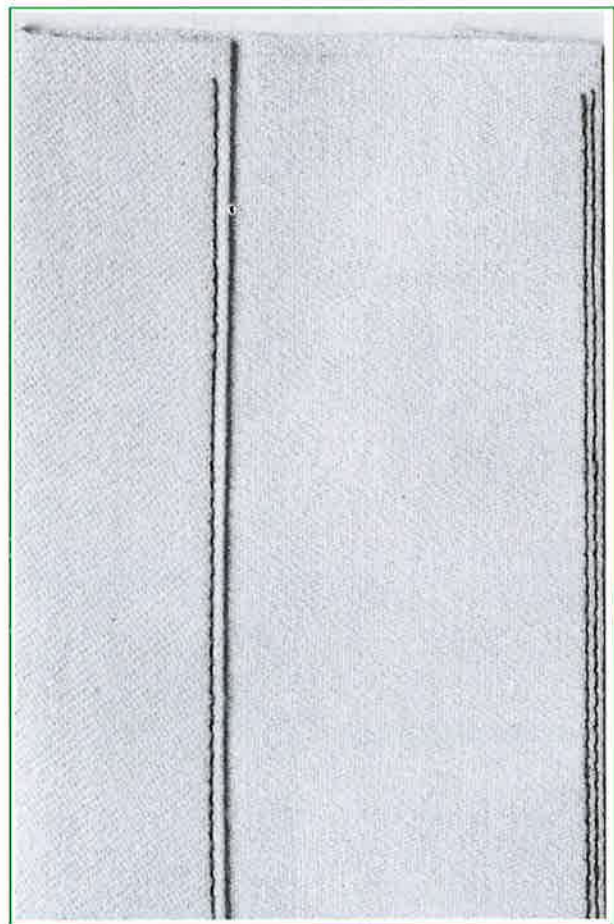

Top stitching, for edges of all kinds.

Presser foot:	1
Thread:	sewing thread
Needle:	80
Stitch:	-----
Stitch width:	0
Stitch length:	2-5 (as required)
Needle position:	any position
Feed-dog:	sewing
Colour indicator:	



Guide the edge of the fabric to the edge of the presser foot or along the grooves in the stitch plate.

Widths:

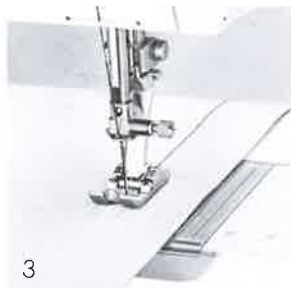
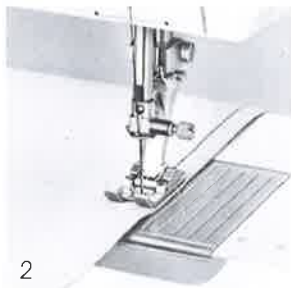
- Needle position centre)
 - Edge of presser foot = 7.5 mm ($\frac{5}{16}$ "'). (Fig. 2)
 - Grooves in stitch plate:
 - Line 1 = 1 cm ($\frac{3}{8}$ "')
 - Line 2 = 1.5 cm ($\frac{5}{8}$ "')
 - Line 3 = 2 cm ($\frac{3}{4}$ "')
 - Line 4 = 2.5 cm (1") (Fig. 3)
 - Line 5 = 3 cm ($1\frac{1}{4}$ "')
- It is also possible to sew intermediate widths using the left, half left, right and half right needle positions.



Buttonhole

Presser foot:	3
Thread:	sewing/darning thread
Needle:	80-70
Stitch:	
Stitch width:	set automatically
Stitch length:	IIIII (satin stitch)
Needle position:	set automatically
Feed-dog:	sewing
Colour indicator:	

To sew buttonholes, thread the lower thread through the finger of the bobbin case (Fig. 1).



1

Setting buttonhole

1. Switch buttonhole knob to position 1 (Fig. 2).

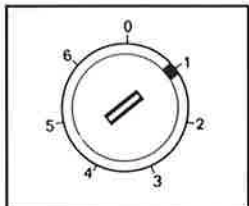

2

2. Set stitch length: Turn knob to the right until it locks. The mark will be at the top (Fig. 3). Stitch length is 0. By rotating half a turn to the left (mark at the bottom) the basic stitch

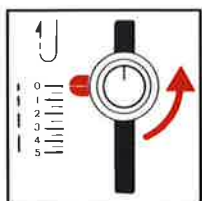

3

length setting for buttonholes is obtained = IIIII.

Set the stitch density according to the fabric. Turn anticlockwise for thicker fabrics, clockwise for finer fabrics.

Always sew a trial buttonhole.

The stitch length will vary slightly depending on the fabric.

Sewing the buttonhole

Lay the fabric under the foot so that the edge of the fabric lies in front of the presser foot (Fig. 4). Lower the needle with the aid of the handwheel and

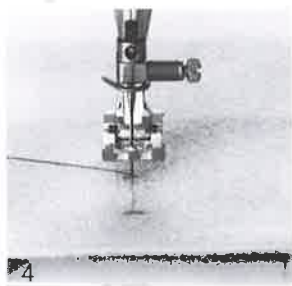

4

check that it is in the **centre** of the presser foot. If not, turn the handwheel. Lower the needle into the fabric precisely at the start of the buttonhole. Lower the presser foot and sew the buttonhole in steps.

Note: After each step, raise the needle by turning the handwheel forward.

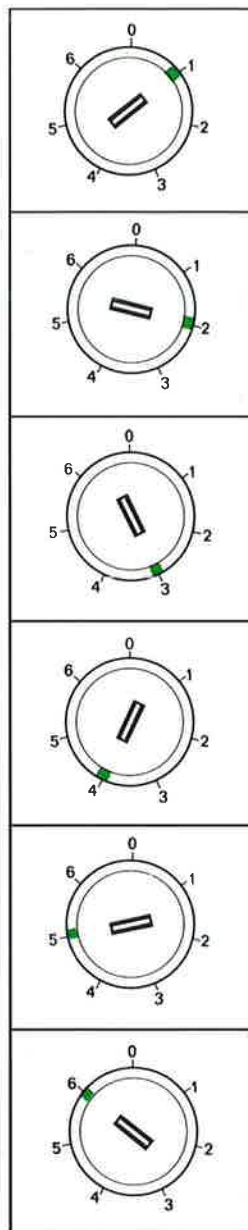

Knob to 1
Machine sews the first bead forwards.

Knob to 2
Machine sews a reverse straight stitch.

Knob to 3
Machine sews the bar tack.

Knob to 4
Machine sews the 2nd bead forwards.

Knob to 5
Machine sews the bar tack.

Knob to 6
Machine sews securing stitches.

Further buttonholes

Reset knob to 1. The sewing sequence continues as described. For all other sewing, set knob to 0.

Cutting the buttonhole open

It is best to cut from each end of the buttonhole towards the centre (Fig. 5). This avoids cutting through a bar tack.

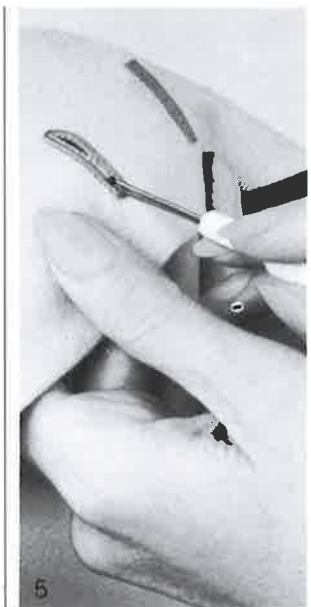

5

Buttonhole with gimp

Buttonhole with gimp cord

The gimp cord strengthens the buttonhole.

The gimp cord is especially important for all knitted fabrics – including hand and machine knits – to prevent the buttonhole from pulling out of shape.

The thickness of the cord depends on the fabric to be sewn. Suitable cords are: perle cord no. 8, thick hand sewing thread or fine crochet cord. Sew a trial buttonhole.

Lay the fabric under the foot so that the folded edge or seam lies in front of the presser foot. The loop of the gimp will lie at the end of the buttonhole where the button will pull (Fig. 1).

Sewing with gimp cord

It is easier to position the cord if the needle is already in the fabric:

1. Using the handwheel, lower the needle and check that it is in the centre of the presser foot. If not, turn the handwheel. Lower the needle into the fabric precisely at the start of the buttonhole. Do not lower the foot yet.

2. Hook the gimp cord over the centre prong of the buttonhole foot and take both ends back under the foot (Fig. 2). Lower the foot and check that the cord is able to slide, i.e. is not trapped by the foot.

3. Sew the buttonhole. At position 2 (reverse straight stitch), the cord comes away from the prong of the foot. Therefore, it is advisable to hold the loop of gimp down LIGHTLY with the finger (Fig. 3).

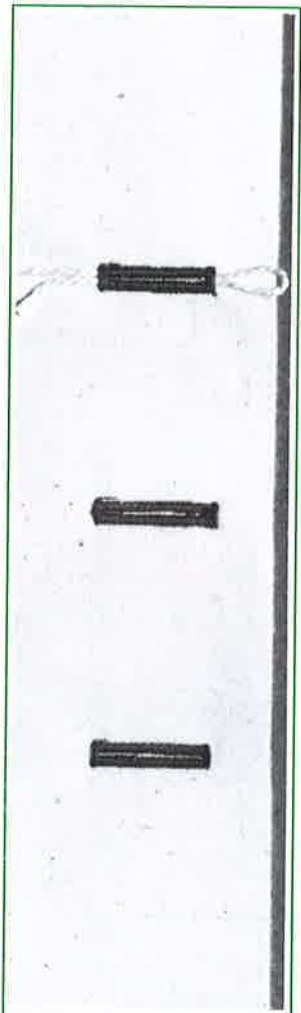
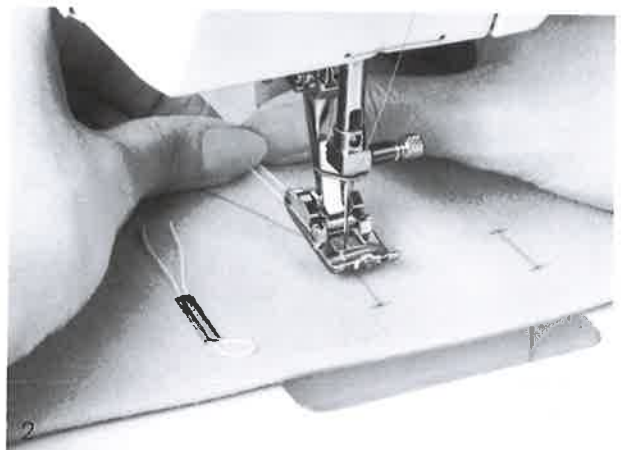
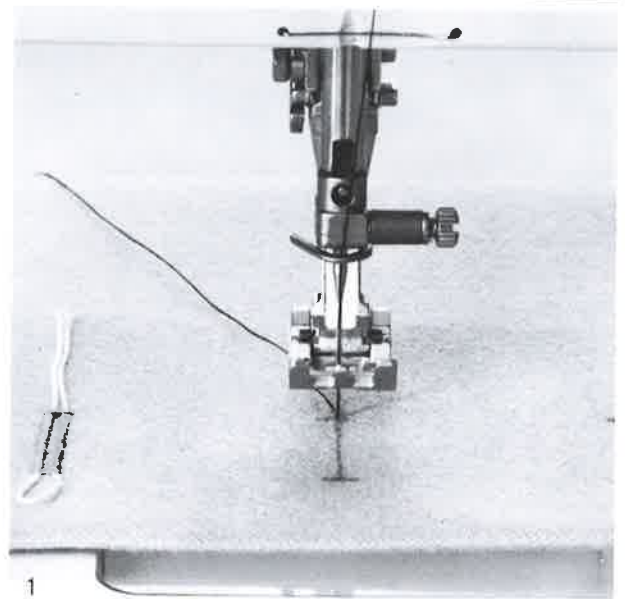

Finally, pull the loop of gimp through. With knitted fabrics, pull the gimp ends to the rear with a coarse hand sewing needle (Fig. 4) and tie or sew in securely. In woven fabrics, the gimp ends can be simply cut off.



Mending interlock fabric

Mending woven fabric

Patching

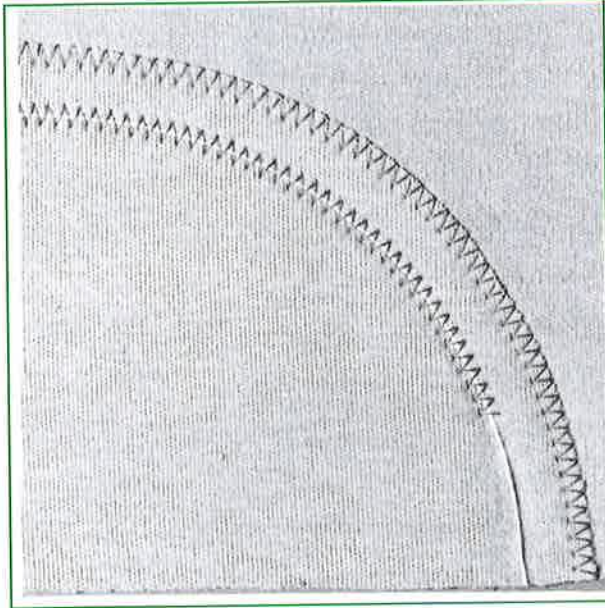

Presser foot:	1
Stitch:	
Stitch width:	3-4
Stitch length:	approx. 1-1½
Needle position:	centre
Feed-dog:	sewing
Colour indicator:	

Can also be sewn with the Universal stitch.



Mending tears using Running stitch

(Modern darning method) for tears and thin areas on virtually all fabrics.

Presser foot:	0
Thread:	darning thread/Machine emb. 60
Needle:	80-70
Stitch:	
Stitch width:	5
Stitch length:	
Needle position:	centre
Feed-dog:	sewing
Colour indicator:	

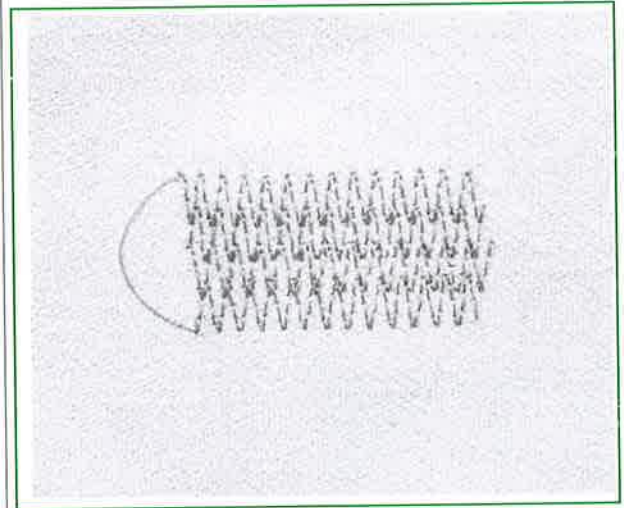

Cut out a patch, if possible from the sound part of a discarded similar garment. Where possible, round off the corners to preserve the elasticity in all directions. Pin on the patch and baste as close as possible to the edge. Then sew with 1-2 rows of zig-zag stitch, possibly sewing in thread simultaneously.

Finally, cut away torn/worn piece from behind patch.

For all knits, refer to the general instructions "Sewing knitted fabrics" on page 20.

Always lay a fine fabric underneath. On tears, sew 3-5 rows of Running stitch, depending on the type of fabric (Fig. 1). On thin areas, sew sufficient adjacent rows to cover. Let each row overlap the previous one very slightly.

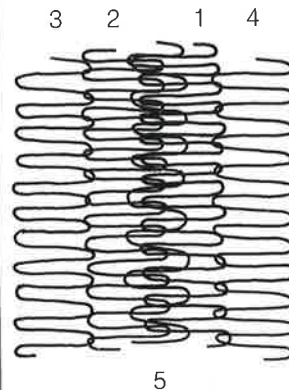



Troubleshooting Maintenance

Fault prevention

If the sewing machine does not sew properly, it is usually due to incorrect use.

Check whether:

- The upper and lower threads are correctly threaded;
- The needle has been correctly inserted with the flat side of the shank to the rear.
- The needle size is correct. See needle and thread table.
- The machine is clean. Brush away any thread remnants.
- The hook race is clean and lubricated.
- Any remnants of thread are trapped between the thread tension disc and beneath the bobbin case spring.

Upper thread breaks

- The upper thread tension is too tight.
- Poor quality needles. Ideally, needles should be purchased from a BERNINA dealer.
- The needle has been incorrectly inserted. The flat side of the shank must be to the rear.
- The needle is blunt or bent.
- Poor quality thread, knotted or dried-out thread.
- Stitch plate or hook tip damaged. Take to a BERNINA dealer.

Lower thread breaks

- The lower thread tension is too tight.
- The bobbin is jamming in the bobbin case. Replace bobbin.
- The hole in the stitch plate has been damaged by the needle. This must be repolished by an expert.
- The needle is blunt or bent.

Skipped stitches

- Wrong needles. Use only 130/705H needle system.
- The needle is blunt, bent or incorrectly inserted. Push right to the top when inserting.
- Poor quality, badly polished needle.
- The needle point does not suit the fabric being sewn. If necessary, use ball point for knitted fabrics and cutting point for leather.

Needle breaks

- Needle clamp screw not sufficiently tightened.
- Fabric withdrawn forwards instead of backwards under the presser foot.
- When sewing over a thick area, the fabric was pushed while needle still in the fabric.
- Poor quality thread, unevenly wound or knotted.

Faults in seams

- Remnants of thread between the thread tension discs.
- Remnants of thread under the bobbin case spring.
- Lower thread still threaded in the bobbin case finger.
- Threaded with foot down.
- Incorrectly threaded. Check lower and upper threads.

Machine fails to run

- Plug is not inserted properly.
- Power switch in 0 position.
- Machine gummed up by use of unsuitable oil. Machine will have to be cleaned by a BERNINA dealer.
- Machine has been standing in a cold room.

Important

If you have to take your machine to a BERNINA dealer, please always take the foot control unit and accessories.

Changing the bulb



WARNING:

Please refer to the safety instructions.

Sewing light:
15 Watt

Changing the bulb

Disconnect the machine from the mains – take the plug out of socket. Using the special bulb holder, press the bulb up, twist to the left and remove.

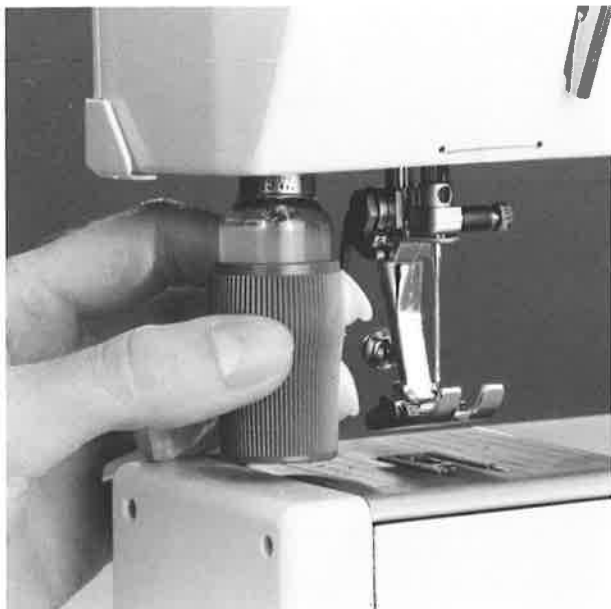

To insert new bulb:
Place the new bulb on the bulb holder.
Insert the bulb into the socket, press upwards and twist to the right as far as it will go.

Maintenance: Cleaning and oiling

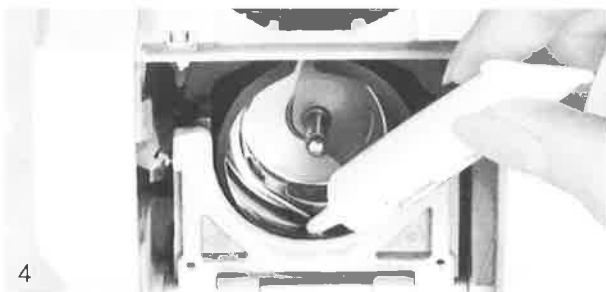
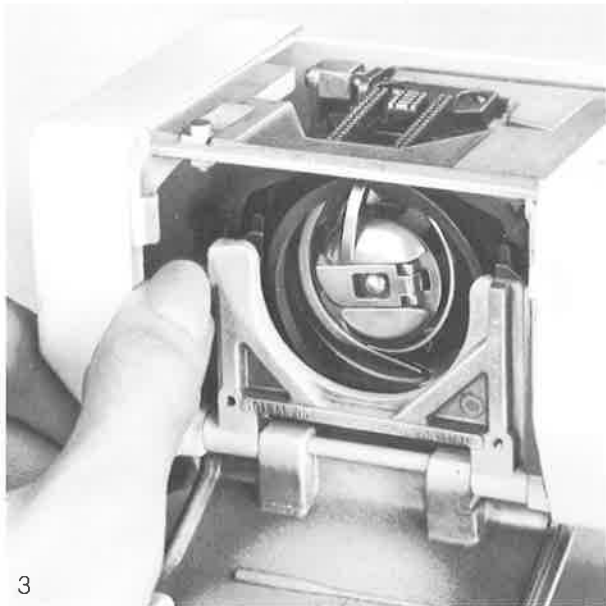
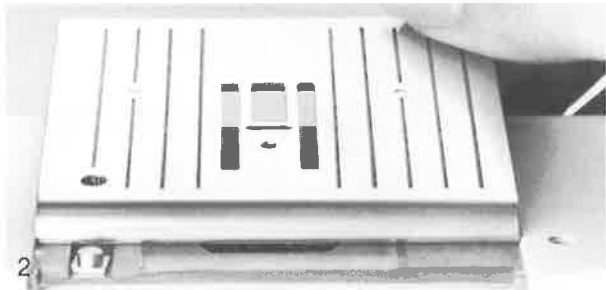
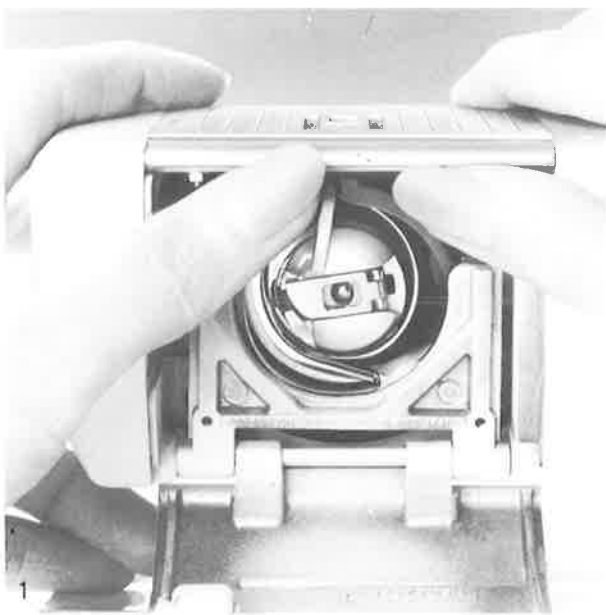

If the machine is stored in a cold room, it should be brought to a warm room approximately one hour before use, to restore the oil in the bearings to a fluid state.

Cleaning

During sewing, fluff from the thread will collect under the stitch plate and around the hook. These remnants must be removed from time to time.

Disconnect the machine from the mains by removing the mains plug from the socket!

- Remove the presser foot and needle.
- Open the hinged front cover on the free arm.
- Lower the feed-dog. Set knob to position .
- Using both thumbs, press the stitch plate up and back (Fig. 1).
- Clean the feed-dog and underside of the stitch plate.
- To refit the stitch plate on the free arm, insert the stitch plate from the rear, push forward until it engages (Fig. 2).

WARNING:

Please refer to the safety instructions.

To oil the hook:
Apply 1–2 drops of oil after 3–4 hours' sewing.

To clean and oil the hook

Disconnect the machine from the mains by removing the mains plug from the socket!

- Take out the bobbin case, see page 4.
- With the thumb of the left hand, press the lower release lever to the left (Fig. 3).
- Fold down the semi-spherical locking strap with the black hook race cover.
- Take out the hook.
- Clean the top and bottom of the hook race with the cleaning brush and cotton cloth. Never use a screwdriver, scissors, etc., to remove remnants of thread.
- Lightly oil the hook race with 1–2 drops of oil (Fig. 4). Insert the hook. If necessary, turn the handwheel until the hook driver is on the left (Fig. 5).
- Close the black hook race cover and locking strap. The pawl must engage.
- Check by turning the handwheel.
- Insert the bobbin case.

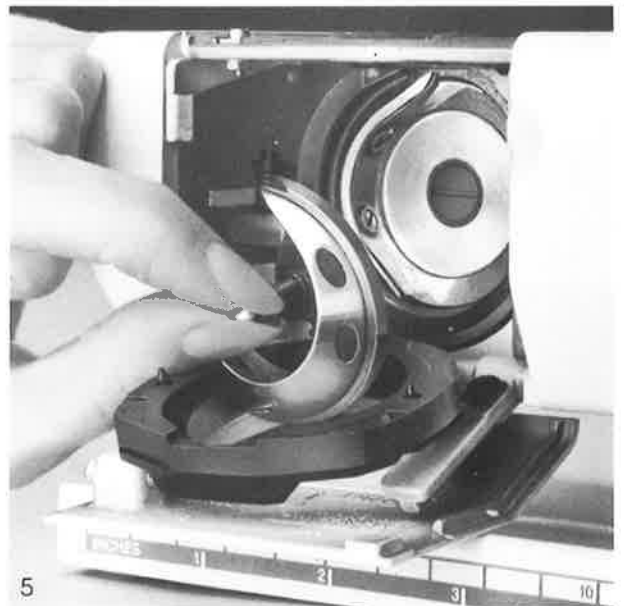

Index

Index

A		F		P		T	
Accessories		Fault prevention	30	Presser feet	14	Thick seams	16
– standard	2	Faulty seams	30	– Blind stitch sole	14	Thread cutter	7,9
Accessories box		Feed-dog		– Buttonhole sole	14	Thread/needle table	10
– removing	2	– and fabric feed	11	– changing	8	Thread tension	7
– attaching	2	– and sewing corners	11	– Overlock sole	14	Threading	
		– and stitch length	11	– Reverse pattern sole	14	– upper thread	6
		– lowering	7	– Zip sole	14	Towelling stitch	15
B		Foot control unit				Triple zig-zag stitch	15
Blind hemming	24	– attaching	3	R			
Blind hem stitch	15	Forwards sewing	16	Reinforced overlock	15	U	
Bobbin				Replacing		Universal stitch	15
– inserting	5	H		– bulb	31	Upper thread	
– winding	4	Hems		– needles	8	– breaks	30
Bobbin case and bobbin		– with practical stitches	21	Reverse sewing	16	– threading	6
– inserting	5	– triple zig-zag	21	Ruler/template			
– removing	4	– universal stitch	21	Running stitch	15		
Bulb		– vari-overlock	21			V	
– changing	31			S		Vari-overlock stitch	15
Buttonhole	26	L		Satin stitch	17		
– with gimp	27	Lower thread		Scallop stitch	15	Z	
		– breaks	30	Securing ends	16	Zig-zag	15, 17
C		– bringing up	7	Seams with		– adjusting	17
Cleaning and		– winding bobbin	4	practical stitches	22	– oversewing edges	17
lubricating	32	Lubricating/cleaning	32	Selecting green stitches	18	– satin stitch	17
Cover	2			Selecting red stitches	19	Zips	20
				Sewing knitted fabrics	20		
D		M		– neckband with			
Decorative stitches	15	Machine cable		overlock stitch	20		
Double overlock stitch	15	– attaching	3	Sewing light	3		
		Machine does not run	32	Sewing tips	9		
		Maintenance	32	Special needles	10		
E		Mending		Standard accessories	2		
Edge stitch	15	– interlock	28	Straight stitch	15, 16		
Edge stitching	25	Mending woven fabrics		– forwards sewing	16		
– top stitching	25	with Running stitch	28	– reverse sewing	16		
– using				– securing ends	16		
needle positions	25			– thick seams	16		
				Stretch stitch	15		
				Supplementary			
				thread guide	6		

WARNING:

Before using your sewing machine, please read the Safety Instructions.

BERNINA®

© Copyright 1997 by Fritz Gegauf AG, Steckborn

97/02 GB 006.214.52.04